



**UNIVERSIDAD DE JAÉN**  

---

**FACULTAD DE CIENCIAS  
EXPERIMENTALES  
DEPARTAMENTO DE QUÍMICA  
FÍSICA Y ANALÍTICA**

**TESIS DOCTORAL  
DESARROLLO DE METODOLOGÍAS  
ANALÍTICAS PARA LA CARACTERIZACIÓN  
QUÍMICA DEL ACEITE DE OLIVA VIRGEN**

**PRESENTADA POR:  
FELIPE JESÚS LARA ORTEGA**

**DIRIGIDA POR:  
DR. D. ANTONIO MOLINA DÍAZ  
DRA. DÑA. BIENVENIDA GILBERT LÓPEZ**

**JAÉN, 14 DE DICIEMBRE DE 2017**

**ISBN 978-84-9159-321-8**



Los doctores Antonio Molina Díaz, Catedrático de Universidad y Bienvenida Gilbert López, Profesora Sustituta Interina, ambos del Área de Química Analítica de la Universidad de Jaén,

Informan:

Que la Tesis Doctoral titulada **“Desarrollo de metodologías analíticas para la caracterización química de aceite de oliva virgen”**, realizada por D. Felipe Jesús Lara Ortega, y que presenta para la obtención del grado de Doctor por la Universidad de Jaén (mención internacional, ha sido desarrollada bajo su inmediata dirección y supervisión, en el Departamento de Química Física y Analítica de la Universidad de Jaén.

En Jaén, a 6 de Noviembre de 2017

Fdo. Antonio Molina Díaz  
Catedrático de Universidad

Fdo. Bienvenida Gilbert López  
Profesora Sustituta Interina



Los trabajos presentados en esta Tesis han sido financiados por la Junta de Andalucía a través del proyecto **"AGR-6066"** del Plan Andaluz de Investigación, convocatoria de 2010 de "Incentivos a Proyectos de Investigación de Excelencia" dentro de la "Línea Específica del Olivar y del Aceite de Oliva" y por el Ministerio de Economía y Competitividad a través del proyecto **"CTQ2012-34297"** beneficiado con una de las **"Ayudas para Contratos Predoctorales para la Formación de Doctores"** con código **"BES-2013-064014"** del Subprograma Estatal de Formación dentro del Programa Estatal de Promoción del Talento y su Empleabilidad, en el marco del Plan Estatal de Investigación Científica y Técnica y de Innovación 2013-2016 del Ministerio de Economía y Competitividad.



*A mi hijo y esposa*  
*A mis padres y hermano*





## Agradecimientos

En primer lugar, me gustaría agradecer a mis directores de tesis Antonio Molina Díaz y Bienvenida Gilbert López por haberme dado la oportunidad y los medios para trabajar en investigación y porque han sido mis guías y mentores desde que me embarqué en esta tesis. Ha sido un honor y un privilegio el poder trabajar con tan experimentados investigadores y tan buenas personas de las que he tenido una gran comprensión incluso en los momentos más difíciles. Por todo ello, GRACIAS.

Un especial agradecimiento merece el doctor Juan Francisco García Reyes, mi tercer mentor, que me ha enseñado los pormenores del desarrollo de un método HPLC, a interpretar los cromatogramas y espectros de masas, y obtener toda la información que ofrecen, además de presentar los trabajos de forma más atractiva y visual.

Agradecer también por su ayuda y apoyo a todos esos fantásticos compañeros y compañeras con los que he tenido la suerte de coincidir: Rafael López Blanco, David Moreno González, Miriam Beneito Cambra, Rocío Nortes Méndez, Francisco Javier Sainz Gonzalo y Juan Carlos Domínguez Romero. Y de entre ellos, destacar la labor y apoyo de José Robles Molina que me enseñó a ser un técnico de reparación y mantenimiento de los equipos, ponerlos a punto y a procesar datos a la velocidad del rayo.

Un especial y germánico agradecimiento a Alexander Schütz (¿o era "Schülz"?), y Sebastian Brandt (Herren BrandtSchütztür); y a todos los que hicieron de mi estancia en Dortmund una experiencia increíble, Felix David Klute, Ulrich Marggraf, Joachim Franzke y Michael Schilling; donde aprendí mucho sobre la descarga de barrera dieléctrica, diseño, y, cómo no, alemán. "Danke schön meine Freunde".

Agradezco con todo mi corazón el trabajo y el esfuerzo que han hecho mis padres para darme la oportunidad de hacer una carrera y así, poder llegar a tener el grado de doctor. Y a mi hermano Martín, por echarme una mano cuando lo he necesitado.

Por último, agradezco la ayuda y comprensión de mi mujer, Paula, el apoyo incondicional y las veces que me ha ayudado en el día a día para llevar a buen puerto este proyecto. Y cómo no, a mi hijo, Gabriel, porque siempre ha conseguido sacarme una sonrisa cuando más lo necesitaba y porque, aunque a veces quería seguir jugando con su papá cuando debía marcharse a la universidad, siempre ha comprendido que es mi obligación, despidiéndome con una sonrisa y recibéndome con gran alegría al volver.





*“La ciencia se compone de errores, que a su vez, son los  
pasos hacia la verdad”*

*Julio Verne*





## *ÍNDICE*

---





---

## ÍNDICE

I. Resumen/Summary.....	23/31
II. Objetivos/Aim of the Thesis.....	39/43
III. Introducción y Antecedentes.....	47
III.1. Aceite de oliva. Contextualización.....	47
III.2. Composición química del aceite de oliva.....	49
III.2.1. Componentes mayoritarios: Triglicéridos.....	49
III.2.2. Componentes minoritarios.....	52
III.2.2.1. Compuestos fenólicos.....	53
III.2.2.2. Tocoferoles y Tocotrienoles.....	56
III.2.2.3. Componentes exógenos: Contaminantes.....	57
III.3. Tipos de análisis requeridos en aceite de oliva.....	57
III.3.1. Categorías comerciales.....	59
III.3.2. Parámetros de calidad.....	60
III.3.3. Criterios de pureza.....	63
III.3.4. Determinación de residuos de plaguicidas en aceite de oliva.....	66
III.4. Técnicas analíticas aplicables a determinaciones en aceite de oliva.....	67
III.4.1. Análisis por inyección en flujo (FIA).....	67
III.4.1.1. Componentes básicos de los sistemas FIA.....	69
III.4.1.2. Sistemas FIA multiconmutados (MCFIA).....	71
III.4.1.3. El análisis por inyección en flujo aplicado al aceite de oliva.....	73
III.4.2. Espectrometría de masas.....	74
III.4.2.1. Análisis directo y acoplamiento de cromatografía de líquidos a espectrometría de masas.....	77
III.4.2.2. Fuentes de ionización convencionales.....	79
III.4.2.3. Papel Spray.....	84
III.4.2.4. Fuentes de ionización por descarga de barrera dieléctrica.....	85

III.5. Antecedentes.....	90
III.5.1. Compuestos fenólicos.....	90
III.5.2. Peróxidos.....	92
III.5.3. Tocoferoles.....	93
III.5.4. Análisis directo de aceite por espectrometría de masas.....	93
III.5.4. Métodos utilizados para la determinación de residuos de plaguicidas.....	94
III.6. Referencias.....	97
IV. Resultados y discusión.....	113
IV. 1. Determinación automática de componentes minoritarios del aceite de oliva virgen relacionados con las propiedades antioxidantes (compuestos fenólicos y tocoferoles) y el estado de oxidación (peróxidos), usando sistemas multiconmutados con detección mediante espectroscopía molecular.....	113
Artículo 1: Multicommutated flow injection method for fast photometric determination of phenolic compounds in commercial virgin olive oil samples.....	115
Artículo 2: Fast automated determination of total Tocopherol content in virgin olive oil using a single multicommutated luminescent flow method.....	139
Artículo 3: Multicommutated flow injection analysis using chemiluminescence detection (MCFIA-CL) for olive oil analysis.....	163
IV. 2. Evaluación de nuevas fuentes de ionización para análisis directo de aceite de oliva y determinación de residuos de plaguicidas mediante espectrometría de masas.....	197
Artículo 4: Direct olive oil analysis by mass spectrometry: a comparison of different ambient ionization methods.....	199
Artículo 5: Overcoming matrix effects and sodium adduct formation in LC-MS using Dielectric Barrier Discharge Ionization.....	227
V. Conclusiones/Conclusions.....	277/283







---

## *Resumen*



## I. Resumen

El aceite de oliva es uno de los pilares de la dieta mediterránea y tiene una especial relevancia en España (sobre todo en la provincia de Jaén), primer país productor mundial de este alimento. Su apreciado valor nutricional deriva de su particular composición: por una parte, la fracción mayoritaria (alrededor del 99%) constituida por triglicéridos (siendo el ácido oleico el ácido graso mayoritario); y por otra, un amplio conjunto de compuestos minoritarios (en torno a 1%) entre los que cabe destacar (aparte de esteroides, ceras, hidrocarburos, alcoholes, clorofilas, carotenos...) los compuestos antioxidantes (compuestos fenólicos y tocoferoles), muy apreciados nutricionalmente por sus potenciales efectos beneficiosos para la salud.

Los métodos convencionales/oficiales para la determinación de compuestos antioxidantes y del estado de oxidación del aceite de oliva son lentos, laboriosos, poco respetuosos con el medio ambiente y además, en algunos de ellos (como es la determinación de peróxidos) la exactitud y reproducibilidad viene en gran medida condicionada por el factor humano (habilidad del operador). Por ello, la primera parte de esta Tesis se ha dedicado al desarrollo de varios métodos automáticos de análisis basados en multiconmutación (empleo de válvulas solenoides de tres vías para el manejo de las disoluciones de reactivos y muestra) para la determinación de componentes minoritarios del aceite de oliva virgen (AOV) relacionados con las propiedades antioxidantes (compuestos fenólicos y tocoferoles) y compuestos indicadores del estado de oxidación (peróxidos). Se pretende con estos métodos contribuir a la mejora de los respectivos métodos convencionales/oficiales en términos de rapidez, sencillez, simplificación, reproducibilidad, reducción de costos y de consumo de reactivos, disolventes y de desechos originados por muestra analizada.

En la segunda parte de la Tesis se aborda el estudio de la espectrometría de masas acoplada a nuevas fuentes de ionización (plasma de baja temperatura, LTP y papel spray, PS) con un doble propósito: por un lado, contribuir a la caracterización de aceite de oliva mediante espectrometría de masas directa, intentando soslayar tanto la problemática asociada a la complejidad de su matriz, como la preparación de la muestra para el análisis; y por otro, contribuir, mediante el uso de una fuente de ionización basa-

da en el principio de descarga de barrera dieléctrica (DBDI), a ampliar la cobertura de ionización en el análisis de pesticidas en aceite de oliva (y otras matrices) con respecto a la de las fuentes convencionales (ESI, APCI).

Así, en el primer bloque se han agrupado los métodos automáticos desarrollados basados en multiconmutado (MCFIA) con detección espectroscópica molecular: absorción UV-visible y emisión de fluorescencia y quimioluminiscencia. Las principales ventajas de estos métodos son, en general, su alta frecuencia de análisis comparada con los respectivos métodos de referencia/convencionales utilizados actualmente (incluso aquellos métodos automáticos previamente descritos en bibliografía), unidos a su simplicidad, automatización, reproducibilidad y respeto medioambiental, que los hacen muy atractivos para su implementación en laboratorios de rutina (y potencial implementación para control en línea de producción en almazaras).

En el artículo 1 se presenta un método para determinación de compuestos fenólicos en AOV, usa espectrofotometría UV-visible (espectrofotómetro modular de fibra óptica) como técnica de detección y está basado en el efecto inhibitor online que ejercen los fenoles/antioxidantes del aceite de oliva virgen (a partir de un extracto hidroalcohólico del mismo) sobre la formación del radical catión  $\text{DMPD}^{\bullet+}$  generado a partir de la reacción de N,N-dimetil-p-fenilendiamina con Fe(III) en medio ácido. Oleoeuropeína se usó como estándar de calibración, encontrándose muy buena correlación con los datos aportados por el método de referencia en el intervalo de concentraciones que habitualmente presentan los aceites de oliva vírgen comerciales. Usando Trolox como calibrante, se obtuvieron asimismo resultados satisfactorios. El método propuesto permite la determinación de compuestos fenólicos/antioxidantes con una drástica reducción del tiempo por análisis (ocho veces inferior) respecto del método convencional de Folin-Ciocalteu.

En el artículo 2 la metodología desarrollada permite determinar el contenido total de tocoferoles, basándose en la fluorescencia nativa de estos compuestos presentes de forma natural en el aceite de oliva. El tratamiento de muestra en este caso fue mínimo, ya que consistió en una simple dilución de la misma con 2-propanol previa a su introducción en el sistema MCFIA. En este estudio se observó que debido a la significativa-



mente mayor cantidad de  $\alpha$ -tocoferol respecto al resto de tocoferoles presentes en el aceite de oliva, se podría usar el contenido total estimado de tocoferoles como una aproximación al contenido de  $\alpha$ -tocoferol. Además, se consiguió una gran velocidad de análisis, unas 40 muestras/hora (frente a 2-4 muestras/h que permite el método oficial mediante HPLC con detección fluorescente), mayor simplicidad y menor costo por análisis, lo que le confiere gran atractivo para ser implementado en laboratorios de análisis de rutina, pudiendo usarse como método de screening o estimación semicuantitativa tanto de  $\alpha$ -tocoferol como de tocoferoles totales.

En el último artículo de este bloque, el artículo 3, se han desarrollado dos métodos automáticos para determinación de: a) índice de peróxidos, y b) compuestos fenólicos/antioxidantes empleando detección quimioluminiscente. La determinación del índice de peróxidos se basa en la reacción del luminol con los hidroperóxidos procedentes de la oxidación de los glicéridos y ácidos grasos, catalizada por Co(II) y usando 1-propanol como disolvente de la muestra (solución monofásica). El método permite la determinación del índice de peróxidos en el intervalo de 14 a 220 meq O<sub>2</sub>/kg (adecuado para verificar si la muestra satisface los requerimientos normativos) a razón de 45 muestras/hora. Frente al método oficial destaca su rapidez, comodidad, precisión y respeto medioambiental. Es el primer método automático descrito para la determinación del índice de peróxidos basado en medidas quimioluminiscentes. La determinación quimioluminiscente de compuestos fenólicos/antioxidantes se basa en la medida directa de la señal quimioluminiscente emitida por el permanganato cuando reacciona con estos compuestos en medio ácido usando tiosulfato como exaltador de la señal. El método permite analizar 180 muestras (extractos)/hora y es el primer método automático descrito para determinación de fenoles/antioxidantes en aceite de oliva virgen por quimioluminiscencia directa.

En el segundo bloque se proponen metodologías para análisis de aceite de oliva virgen basadas en la espectrometría de masas. Se evalúa el potencial de la espectrometría de masas con fuentes de ionización no convencionales: a) fuentes de ionización ambiental (LTP y PS) para análisis directo de aceite; y b) descarga de barrera dieléctrica (DBD) para el análisis de plaguicidas.

En el artículo 4 se ha evaluado el uso de la espectrometría de masas directa con fuentes de ionización ambiental (AIMS) para la caracterización del aceite de oliva virgen, usando plasma de baja temperatura (LTP) y papel spray (PS). En ambos casos se minimiza el efecto memoria y los problemas de complejidad de la matriz comparado con la infusión directa (sólo una fracción de muestra es desorbida) y permiten el análisis directo o previa simple dilución. La información sobre la muestra proporcionada por ambas técnicas es diferente: compuestos con  $m/z > 500$  prácticamente no se desorben de la muestra cuando se emplea LTP. Por tanto, no se obtiene información sobre tri-, di- y monoacilglicéridos. La técnica PS resulta superior a LTP en este aspecto, ionizándose un mayor rango de especies, lo que puede permitir la clasificación de las muestras. Además, el uso de sales de plata en PS ofrece la posibilidad de análisis de compuestos insaturados, proporcionando información sobre el perfil de muestras de aceite de oliva virgen en dichos compuestos.

Por último, en el artículo 5 se ha explorado el uso de la fuente de ionización basada en la descarga de barrera dieléctrica (DBDI), que permite la posibilidad de generar tanto iones positivos como negativos, en su aplicación al análisis multiresiduo de plaguicidas en aceite de oliva, (y otras matrices, como por ejemplo, naranjas y aguas residuales). Dicha fuente permite el análisis multiresiduo de plaguicidas, incluyendo diferentes rangos de características físico-químicas, con resultados muy satisfactorios, dado que permite la detección de compuestos ionizables por las fuentes convencionales (ESI, APCI) y muchos no ionizables por ellas, presentando así, respecto a éstas, una mayor cobertura de ionización de analitos con distintas propiedades fisicoquímicas. El uso de pulsos eléctricos de onda cuadrada contribuyó a mejorar la sensibilidad y el efecto matriz comparado tanto con las fuentes convencionales como con trabajos previos descritos en bibliografía que han usado DBDI para el análisis de otras matrices vegetales.







---

## *Summary*



## II. Summary

Olive oil is one of the cornerstones of the Mediterranean diet and has a special relevance in Spain (especially in the province of Jaén), the world's leading producer of this product. Its appreciated nutritional value derives from its particular composition: on the one hand, the major fraction (about 99%) consisting of triglycerides (oleic acid being the major fatty acid); and on the other hand, a wide range of minor compounds (around 1%), among which (apart from sterols, waxes, hydrocarbons, alcohols, chlorophylls, carotenes) the antioxidant compounds (phenolic compounds and tocopherols) are very appreciated from the nutritional point of view for its potential beneficial effects on health.

The conventional/official methods for the determination of antioxidant compounds and the oxidation state of olive oil are slow, laborious, not much environmentally friendly and in some of them (such as the determination of peroxides) the accuracy and reproducibility is largely conditioned by the human factor (operator ability). For this reason, the first part of this thesis has been dedicated to the development of several automatic methods of analysis based on multicommutation (use of three-way solenoid valves for the handling of reagents and sample solutions) for the determination of minor components of the virgin olive oil (VOO) related to antioxidant properties (phenolic compounds and tocopherols) and oxidation state compounds (peroxides). It is intended to contribute with these methods to the improvement of the respective conventional/official methods in terms of speed, simplicity, reproducibility, reduction of costs, minor consumption of reagents, solvents, and waste originated by analyzed sample.

The second part of the thesis deals with the study of mass spectrometry coupled to new ionization sources (low temperature plasma, LTP and paper spray, PS) with a dual purpose: contribute to the characterization of oil of olive by means of direct mass spectrometry, trying to avoid both the problem associated with the complexity of its matrix and the preparation of the sample for the analysis; to contribute, through the use of the dielectric barrier ionization source (DBDI), to extend ionization coverage in the analysis of pesticides in olive oil (and other matrices) with respect to that of the conventional-sources (ESI, APCI).

Thus, in the first part are grouped the developed automatic methods based on multi-commutation (MCFIA) with molecular spectroscopic detection: UV-visible absorption and emission of both fluorescence and chemiluminescence. The main advantage of these methods are, in general, their high frequency of analysis compared to the respective reference/conventional methods currently used (including those automatic methods previously described in the literature), together with their simplicity, automation, reproducibility and environmental respect, which make them very attractive for their implementation in routine laboratories (and potential implementation for on-line production control in mills).

In article 1 a method for the determination of phenolic compounds in VOO is presented, using UV-visible spectrophotometry (modular optical fiber spectrophotometer) as a detection technique and is based on the online inhibitory effect of phenols/antioxidants of virgin olive oil (from a hydroalcoholic extract thereof) on the formation of the radical  $DMPD^{•+}$  generated from the reaction of N, N-dimethyl-p-phenylenediamine with Fe (III) in acid medium. Oleuropein was used as a calibration standard, with very good correlation with the data provided by the reference method in the range of concentrations usually present in commercial virgin olive oils. Using Trolox as a calibration standard, satisfactory results were also obtained. The proposed method allows the determination of phenolic compounds/antioxidants with a drastic reduction of analysis time (eight times lower) compared to the conventional method of Folin-Ciocalteu.

In the article 2 the methodology developed allows to determine the total content of tocopherols, based on the native fluorescence of these naturally occurring compounds in olive oil. The sample treatment in this case was minimal, since it consisted in a simple dilution of the sample with 2-propanol prior to its introduction into the MCFIA system. In this study, it was observed that due to the significantly higher amount of  $\alpha$ -tocopherol compared to the remaining tocopherols present in olive oil, the total estimated content of tocopherols could be used as an approximation to  $\alpha$ -tocopherol content.

In addition, a high speed of analysis, about 40 samples/hour, compared to 2-4 samples/h required by the official HPLC method with fluorescence detection, greater simplicity and cost per analysis was achieved, which gives it great appealing to be implemented



in routine analysis laboratories, being able to be used as screening method or semi-quantitative estimation of both  $\alpha$ -tocopherol and total tocopherols.

In the last article of this part, article 3, two automatic methods have been developed for the determination of: a) peroxide value, and b) phenolic compounds / antioxidants using chemiluminescent detection. The determination of the peroxide value is based on the reaction of the luminol with the hydroperoxides from the oxidation of the glycerides and fatty acids, catalyzed by Co (II) and using 1-propanol as the solvent of the sample (single-phase solution). The method allows the determination of the peroxide value in the range of 14 to 220 meq O<sub>2</sub>/kg (suitable to verify if the sample meets regulatory requirements) at the rate of 45 samples/hour. Regarding the official method, it should be emphasized its speed, precision and environmental respect. It is the first automatic method described for the determination of the peroxide value based on chemiluminescent measurements. The chemiluminescent determination of phenolic compounds/antioxidants is based on the direct measurement of the chemiluminescent signal emitted by permanganate when reacted with these compounds in sulfuric medium using thiosulfate as signal enhancer. The method allows the analysis of 180 samples (extracts)/hour and is the first automatic method described for determination of phenols / antioxidants in virgin olive oil by direct chemiluminescence.

In the second part, methodologies for virgin olive oil analysis based on mass spectrometry are proposed. The potential of mass spectrometry with non-conventional ionization sources is evaluated: a) ambient ionization sources (LTP and PS) for direct oil analysis; and b) dielectric barrier discharge (DBD) for the analysis of pesticides.

The use of ambient ionization mass spectrometry (AMS) for the characterization of virgin olive oil using low temperature plasma (LTP) and paper spray (PS) has been evaluated in article 4. In both cases, carry-over and matrix effects are minimized compared to direct infusion (because only a fraction of sample is desorbed) and allow direct or simple dilution prior to the analysis. The information on the sample provided by both techniques is different: compounds with  $m/z > 500$  are practically not desorbed from the sample when LTP is used. Thus, no information is available on tri-, di- and mono-acylglycerides. The PS technique is superior to LTP in this aspect, ionizing a greater range of species, which

can allow the classification of the samples. In addition, the use of silver salts in PS offers the possibility of analysis of unsaturated compounds, providing information on the profile of these compounds in virgin olive oil samples.

Finally, article 5 explores the use of the dielectric barrier discharge ionization source (DBDI), which allows the possibility of generating both positive and negative ions, to multi-residue analysis of pesticides in oil olive, (and also in other matrices such as oranges and wastewaters). This source allows the multiresidue analysis of pesticides, of a wide range of physicochemical characteristics, with very satisfactory results: it allows the detection of compounds ionized by conventional sources (ESI, APCI) and many others non ionized by these ionization sources, so reaching, regarding conventional sources, a greater coverage of ionization of analytes with different physicochemical properties. The use of square wave electric pulses contributed to improve sensitivity and matrix effect compared to both conventional sources and previous work described in the literature which used DBDI for the analysis of other vegetable matrices.







---

## *Objetivos*



## **II. Objetivos**

1. Desarrollar metodologías analíticas basadas en el empleo de técnicas espectroscópicas combinadas con sistemas de flujo continuo para el análisis rápido y automatizado de componentes minoritarios de interés del aceite de oliva cuya presencia se asocia a un producto más saludable (componentes fenólicos y tocoferoles) o deprecia el producto (hidroperóxidos).
2. Desarrollar metodologías analíticas basadas en el empleo de técnicas de ionización en condiciones ambientales para el análisis directo de aceite de oliva mediante espectrometría de masas.
3. Desarrollar metodologías analíticas basadas en el empleo de técnicas cromatográficas acopladas a espectrometría de masas usando la ionización por descarga de barrera dieléctrica (DBDI) para la detección de residuos de plaguicidas en aceites de oliva.







---

*Aim of  
the Thesis*



## **II. Aim of the Thesis**

1. To develop analytical methodologies based on the use of spectroscopic techniques combined with continuous flow systems for the rapid and automated analysis of minor components of olive oil, whose presence is associated with a healthier product (phenolic components and tocopherols) or depreciate the product (hydroperoxides).
2. To develop analytical methodologies based on the use of ambient mass spectrometry for the direct analysis of olive oil samples.
3. To develop analytical methodologies based on the use of chromatographic techniques coupled to mass spectrometry using dielectric barrier ionization (DBDI) for the detection of pesticide residues in olive oils.





---

*Introducción y  
Antecedentes*



### III. Introducción y Antecedentes

#### III.1. Aceite de oliva. Contextualización.

El aceite de oliva es uno de los alimentos protagonistas de la dieta mediterránea, ya que con él se elaboran la mayoría de los platos de la misma. La dieta mediterránea es considerada desde el año 2013 como patrimonio inmaterial de la humanidad por la UNESCO, ya que representa al modo de vida de los países de la cuenca del Mediterráneo que se ha transmitido de generación en generación desde hace milenios. Como parte principal de la misma, el aceite de oliva posee también una gran importancia desde el punto de vista histórico, el nutricional y el socioeconómico, aspectos que suelen estar relacionados entre sí y tienen un considerable impacto en las zonas productoras.

Desde el punto de vista histórico, el aceite de oliva ha sido un producto muy apreciado por varias civilizaciones, como los fenicios, que lo trajeron a la Península Ibérica a finales del segundo milenio a.C. [1], los griegos, los romanos y los árabes. De hecho, el árabe ha influenciado enormemente el vocabulario español relativo al olivo; como almazara (*alma'sára*) o alcuza (*alkúza*); y, por supuesto, aceite (*azzáytl*) y aceituna (*azzaytúna*) [2]. Desde tiempos remotos hasta la actualidad, tanto la superficie de olivos, como el consumo de aceite de oliva ha ido sufriendo altibajos en España en particular, y en el mundo en general, a merced de los distintos factores económicos y sociales [3].

Desde el punto de vista económico, los datos recopilados en los últimos años, tanto por organismos españoles [4,5] como internacionales [6] reportan que en torno al 75% de la producción mundial de aceite de oliva procede de la Unión Europea, de manera que España contribuye con casi el 40% de la producción mundial de aceite de oliva, como se puede observar en la Figura III.1. Tales cifras son abrumadoras, sobre todo si comparamos con el segundo país en este ranking, Italia, cuya producción suele ser la mitad o menos de la española. Esta producción se sustenta en casi 2.500.000 hectáreas dedicadas al cultivo del olivo en España para la producción de aceite de oliva [7,8], de las cuales casi 1.450.000 son andaluzas. La provincia de Jaén, con cerca de 600.000 hectáreas de olivos, representa en torno al 25% de la superficie española destinada a este cultivo. Esto se traduce en que el 38% de la producción española de aceite de oliva

virgen en el año 2015 (últimos datos disponibles) procedía de la provincia de Jaén [9]. Es por ello que Jaén es conocida como la capital mundial del aceite de oliva, con una producción de aceite de oliva virgen superior a las 525.000 toneladas en la campaña 2015/2016 [9], superior a las aproximadamente 475.000 toneladas que produjo Italia, o las 320.000 toneladas que produjo Grecia [6].



Figura III.1. Porcentaje de producción mundial media de aceite de oliva desde la campaña 1991/92 hasta la 2014/15 (Fuente: Datos del Consejo Oleícola Internacional).

España no es sólo el principal país productor de aceite de oliva, sino que también es un gran consumidor del mismo, concretamente el segundo país consumidor después de Italia. En la campaña 2015/2016, se produjeron en España 1.401.000 toneladas de aceite de oliva [6], se consumieron unas 502.500 [6] y se exportaron casi 897.000 toneladas (571.000 dentro de la UE [10] y 326.000 fuera de la UE [6]). Estos datos reflejan la importancia del aceite de oliva a nivel económico, pero también indican un hábito de consumo de la sociedad española, que desde tiempos remotos ha considerado al aceite de oliva como una sustancia saludable y sanadora.

Desde el punto de vista nutricional, el aceite de oliva está compuesto en torno a un 98-99%, por triglicéridos [11], que contienen una gran cantidad de ácidos grasos insatura-

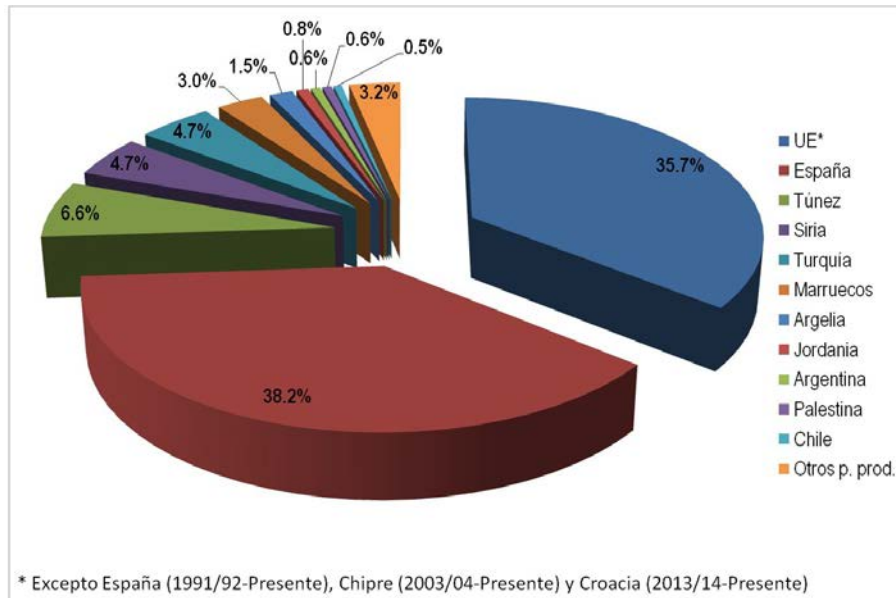

dos, destacando como mayoritario el ácido oleico, un ácido graso monoinsaturado [11]. Los ácidos grasos monoinsaturados ayudan a reducir el nivel de LDL (*Low Density Lipoprotein* o "colesterol malo") y a aumentar el nivel de HDL (*High Density Lipoprotein* o "colesterol bueno") como se demostró hace décadas [12,13], previniendo así la aparición de aterosclerosis. Pero las bondades que sobre la salud aporta el aceite de oliva no solo estriban en su perfil de ácidos grasos, sino también en varios de sus componentes minoritarios como son los polifenoles y los tocoferoles, ambos con poder antioxidante. Estos compuestos previenen un pronto enranciamiento del aceite de oliva y también ayudan a bloquear el estrés oxidativo que los radicales libres producen en nuestro organismo [14–16]. Estas propiedades lo convierten en una grasa excepcionalmente saludable.

### III.2. Composición química del aceite de oliva

El aceite de oliva es un alimento netamente graso debido a que está constituido en torno al 98-99% por triglicéridos. El 1-2% restante está formado por componentes de distinta naturaleza fisicoquímica (polifenoles, tocoferoles, alcoholes, hidrocarburos, pigmentos, etc), que debido a su baja concentración en el aceite son comúnmente llamados componentes minoritarios [11]. También se pueden encontrar componentes exógenos al aceite de oliva, como son los contaminantes. Estos contaminantes pueden provenir de los productos fitosanitarios usados en el cultivo del olivar, de la maquinaria y vehículos usados durante las prácticas agrícolas y de las aguas de las que se nutre el olivar.

#### III.2.1. Componentes mayoritarios: Triglicéridos

La fracción mayoritaria del aceite de oliva está constituida casi exclusivamente por triglicéridos. Estas biomoléculas son usadas por los seres vivos principalmente como reserva y fuente de energía. Los triglicéridos, también denominados triacilglicéridos o triacilgliceroles (TAGs), son ésteres de una molécula de glicerol con tres ácidos grasos. Los triglicéridos pueden ser descompuestos en glicerol y sales de ácidos grasos (jabones) mediante la adición de hidróxido de sodio o de potasio en un proceso llamado saponificación, quedando el glicerol en una fase distinta llamada materia insaponifica-

ble. En la fracción saponificable del aceite de oliva, además de los triglicéridos se pueden encontrar ácidos grasos libres, mono- y diglicéridos (ésteres de glicerol con uno o dos ácidos grasos, respectivamente), fosfolípidos y ceras. Los glicéridos parciales (mono- y diglicéridos) pueden estar presentes en el aceite de oliva de forma natural debido a una síntesis incompleta de los triglicéridos (como los 1,2-diglicéridos), o bien debido a procesos de degradación como la hidrólisis (como los 1,3-diglicéridos) [11].

Los ácidos grasos son cadenas hidrocarbonadas con un grupo carboxilo en uno de los extremos. Son de naturaleza lipídica y cuanto más larga es la cadena, más apolar es su naturaleza. Pueden presentar insaturaciones o dobles enlaces carbono-carbono, distinguiéndose como ácidos grasos poliinsaturados (varias insaturaciones), monoinsaturados (una insaturación) y saturados (ninguna insaturación). Algunos ejemplos de ácidos grasos con distinto número de insaturaciones se muestran en la Figura III.2. Habitualmente se usa la nomenclatura simplificada para nombrar los ácidos grasos, en la que se indica el número de carbonos del ácido graso y el número de insaturaciones del mismo. Por ejemplo, el ácido oleico posee 18 carbonos y una insaturación por lo que lo nombramos como C18:1.

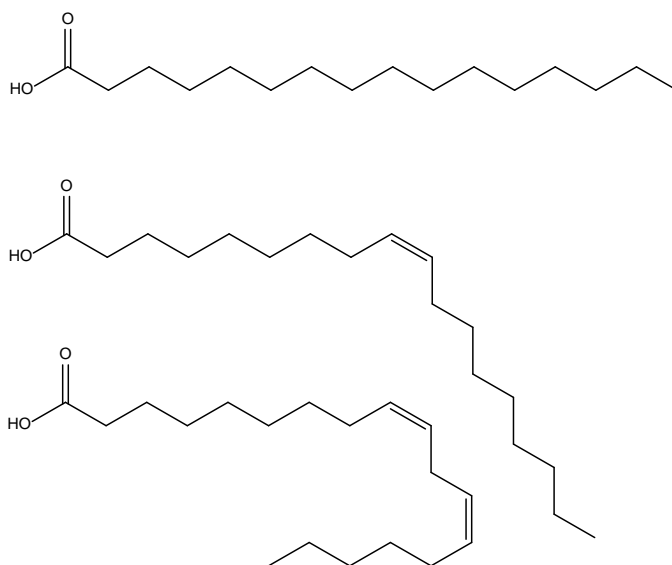

**Figura III.2.** Ejemplos de ácidos grasos del aceite de oliva. De arriba abajo: ácido palmítico (C16:0), ácido oleico (C18:1) y ácido linoléico (C18:2).

Los ácidos grasos presentes en el aceite de oliva son mirístico (C14:0), palmítico (C16:0), palmitoleico (C16:1), heptadecanoico (C17:0), heptadecenoico (C17:1), esteárico (C18:0), oleico (C18:1), linoléico (C18:2), linolénico (C18:3), araquídico (C20:0), eicosenoico (C20:1), behénico (C22:0) y lignocérico (C24:0) [11]. Se puede indicar la posición de la primera insaturación utilizando la nomenclatura omega ( $\omega$ ), que enumera el número de carbonos empezando por el lado opuesto al grupo carbonilo. Así, por ejemplo, el ácido oleico es un ácido  $\omega$ -9, mientras que el ácido linoléico es un ácido  $\omega$ -6. También cabe mencionar que las insaturaciones de estos ácidos grasos presentan mayoritariamente la conformación *cis*, siendo la *trans* muy minoritaria o nula.

El perfil de ácidos grasos en el aceite de oliva tiene un patrón bien definido, aún con ciertas variaciones producidas por la cosecha, la climatología y la variedad de aceituna [17]. Existe un claro predominio del ácido oleico (C18:1), que supone un 55-83% del total de ácidos grasos, al que le siguen en importancia el ácido linoléico (C18:2), que representa un 3,5-21% del total, y el palmítico (C16:0), que se encuentra entre 7,5-20% del total. Del mismo modo, las combinaciones de los distintos ácidos grasos para formar triglicéridos son limitadas en el aceite de oliva, puesto que solo unos pocos tipos de triglicéridos son los que se encuentran naturalmente [11]. Destaca como mayoritario la trioleína (OOO), es decir, el triglicérido formado por la esterificación de tres moléculas de ácido oleico y una de glicerina (ver figura III.3.), con un predominio de 40-59% de los triglicéridos totales. Se ha demostrado que la distribución de los ácidos grasos en el triglicérido no es aleatoria [18,19], sino que los ácidos grasos en la posición 2 (central) son insaturados. Por ejemplo, el ácido linolénico resulta favorecido frente al ácido oleico y el linoleico para ocupar la posición central.



Figura III.3. Estructura de la trioleína.

### III.2.2. Componentes minoritarios

Como se ha indicado anteriormente, algunos de los compuestos minoritarios del aceite de oliva pueden encontrarse en la fracción saponificable: aquellos que también están formados mediante reacciones de esterificación de ácidos grasos.

En primer lugar, se puede mencionar los fosfolípidos, que son muy similares estructuralmente a los triglicéridos; la diferencia radica en que en la posición 3, el glicerol forma un enlace éster con un grupo fosfato. Son, por tanto, lípidos anfipáticos, presentando un extremo hidrofóbico y otro hidrofílico; propiedad usada en la formación de las membranas celulares de las que suelen formar parte [11]. La esterificación de ácidos grasos y otros alcoholes presentes en el aceite de oliva distintos del glicerol genera ésteres de alquilo (ésteres con alcoholes de bajo peso molecular) [17] y ceras (ésteres de ácidos grasos con alcoholes de alto peso molecular), mucho más comunes en el aceite de oliva [11,17]. Finalmente, también es posible encontrar ésteres de esteroides, formados por la reacción de un ácido graso con un alcohol esteroideo.

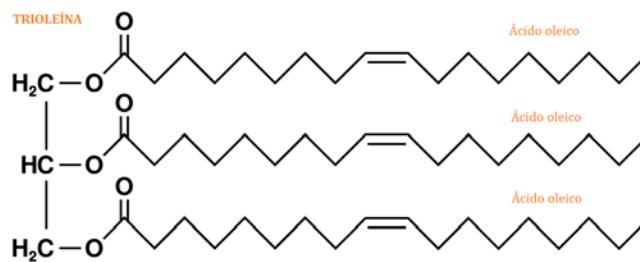
Tras una reacción de saponificación, todos los alcoholes, incluidos glicerol, alcoholes alifáticos y esteroides, pasarían a la fracción insaponificable junto con el resto de componentes minoritarios. Los esteroides son compuestos cuya base estructural deriva del ciclopentanoperhidrofenantreno [17], también base estructural del colesterol y las hormonas esteroideas. Los principales esteroides del aceite de oliva son:  $\beta$ -sitosterol,  $\Delta$ -5-avenasterol y campesterol [11,20]. Los alcoholes terpénicos que se encuentran en la fracción insaponificable también son importantes para la detección de adulteraciones con aceites de orujo, principalmente la determinación de eritrodol y uvaol [11,17].

También se encuentran hidrocarburos (cadenas hidrocarbonadas carentes de grupos funcionales) en la fracción insaponificable. Sus niveles aumentan durante el refinado. Los hidrocarburos presentes en el aceite de oliva se pueden dividir en tres grupos según su naturaleza: terpénicos, esteroideos, o policíclicos aromáticos. Los principales hidrocarburos en aceite de oliva son el escualeno (Figura III.4) y el  $\beta$ -caroteno, ambos terpenos, y que han sido objeto de numerosos estudios [21,22].



Figura III.4. Fórmula estructural del escualeno.

El  $\beta$ -caroteno también es un pigmento que se puede encontrar en el aceite de oliva junto con otros carotenoides, de entre los que destaca la luteína. Éstos le dan al aceite un color entre amarillo y anaranjado. Otros pigmentos presentes en el aceite de oliva son clorofilas y feofitinas (derivados de clorofilas sin el átomo metálico central), de color verde. Los niveles de estos pigmentos varían en función de los factores ambientales [11,23].

Los compuestos volátiles, [11,24] que dan al aceite de oliva su olor característico y que juegan un papel fundamental en el análisis sensorial, también se encuentran en la fracción insaponificable. Son de muy diversa naturaleza, incluyendo hidrocarburos, éteres, alcoholes, aldehídos, cetonas, ácidos y ésteres, entre otros. La cantidad y el tipo de estos compuestos son muy variados y depende de factores ambientales.

A continuación se describirán con un poco más de detalle aquellos compuestos minoritarios de mayor relevancia para esta tesis doctoral, incluyendo aquellos que presentan propiedades antioxidantes, como son los compuestos fenólicos, tocoferoles y tocotrienoles.

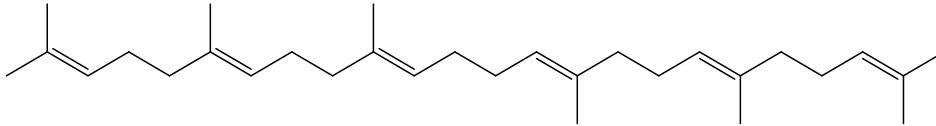
#### III.2.2.1. Compuestos fenólicos

Amplio y heterogéneo grupo de compuestos cuya parte estructural común es un anillo de benceno con uno o más grupos hidroxilo unidos a éste; se les suele llamar polifenoles de forma genérica, incluidos aquellos que solo tengan un grupo hidroxilo unido al anillo aromático. Tienen capacidad antioxidante y se les ha relacionado con el mayor o menor amargor que presenta el aceite de oliva. Su concentración varía en función de la variedad o variedades de las aceitunas con las que se ha producido el aceite, aunque también de las condiciones del proceso de producción [25–28]. De los compuestos pertenecientes a esta gran familia que están presentes en el aceite de oliva, se pueden

distinguir cinco grupos [29,30]: 1) alcoholes fenólicos, 2) ácidos fenólicos, 3) lignanos, 4) secoiridoides, 5) flavonoides.

Alcoholes fenólicos. Los alcoholes fenólicos presentes en el aceite de oliva son principalmente el tirosol (4-hidroxifeniletanol) y derivados del mismo como el hidroxitirosol (3,4-dihidroxifeniletanol), cuyas estructuras se muestran en la Figura III.5. Su concentración es muy variable aunque se puede decir que aproximadamente la mitad corresponde a estos fenoles y sus derivados [31]. Un derivado muy interesante del tirosol es el oleocantal, un éster de este fenol que ha suscitado interés tanto por el ligero picor en la garganta que provoca su consumo como por la actividad antioxidante y, sobre todo, antiinflamatoria, que se le atribuye [15,32].



Figura III.5. Estructura del tirosol (izquierda), hidroxitirosol (centro) y oleocantal (derecha).

Ácidos fenólicos. Por otro lado, los ácidos fenólicos se pueden dividir en dos grupos: a) los basados en el ácido benzoico, que son ácido benzoico, p-hidroxibenzoico, protocatéquico, gálico, vanílico y sirínico, y b) los basados en el ácido cinámico, que son ácido cinámico, p-cumárico, o-cumárico, cafeico, ferúlico, y sinápico. Estos ácidos fenólicos se han relacionado con atributos organolépticos y con funciones beneficiosas para la salud que hacen que el aceite de oliva pueda ser considerado como un alimento funcional [29,30].

Lignanos. Los lignanos son compuestos fenólicos cuya estructura básica es similar a la dimerización de dos ácidos vanílicos o ferúlicos. Entre los lignanos hallados en aceite de oliva, se ha reportado la presencia de (+)-1-pinoresinol, que suele encontrarse en

una concentración relativamente constante (0.02-0.025 g/kg) en aceites españoles, y (+)-1-acetoxipinoresinol, de concentración muy variable (0.002-0.095 g/kg)[33,34].

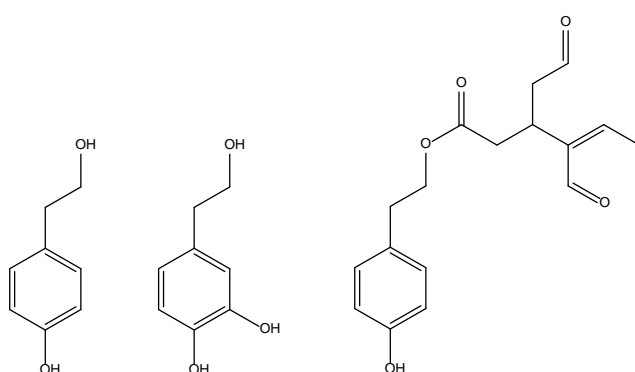
Secoiridoides. Otros compuestos de gran interés son los secoiridoides que, junto con los lignanos, son los más abundantes en el aceite de oliva virgen. Se caracterizan por la presencia de ácido elenólico (secoiridoide) en su estructura, un alcohol fenólico (tirosol o hidroxitirosol) y, usualmente, un resto de un glucósido. Están presentes en cantidades de 27-32 mg/kg de aceite y pueden presentarse en su forma libre o glucosilada [20,29,30]. El principal glicósido presente en el aceite de oliva es la oleuropeína, un éster del ácido elenólico con el hidroxitirosol [35]. Otro secoiridoide de interés presente en el aceite de oliva es el ligustrósido, que tiene una estructura similar a la de la oleuropeína, pero con tirosol en lugar de hidroxitirosol; ambos compuestos se muestran en la Figura III.6. A estos compuestos se les atribuye el amargor del aceite [29,30].

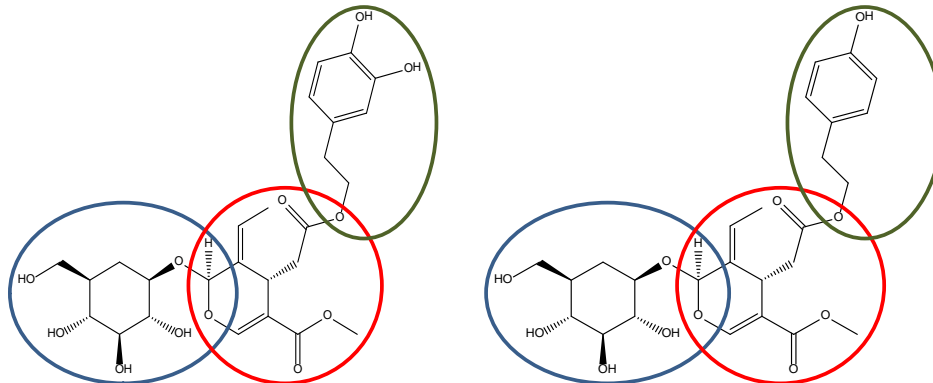

**Figura III.6.** Estructura de la oleuropeína (izq) y ligustrósido (der). Dentro del círculo azul se encuentra el residuo del glucido, dentro del rojo aparece el ácido elenólico y dentro del verde se aprecia el fenol

Flavonoides. Estos compuestos tienen como base de su estructura a la flavona, un compuesto que presenta anillos aromáticos. Dentro del subgrupo de las flavonas destacan en aceite de oliva la apigenina y la luteoleína que pueden ser halladas en su forma libre y glucosilada [36]. También se ha hallado en aceites españoles un miembro del subgrupo de las flavononas, el (+)-taxifolin [37].

### III.2.2.2. Tocoferoles y tocotrienoles

Son compuestos que comparten una base estructural, en este caso la del 6-cromanol con una cadena isoprenoide saturada en caso de los tocoferoles y triinsaturada no conjugada en el caso de los tocotrienoles [17]. Son compuestos liposolubles y aparecen en la fracción insaponificable del aceite. Hay cuatro tocoferoles y cuatro tocotrienoles, llamados usualmente tocoles, cuya diferencia estriba en la presencia o ausencia de metilos en la posición meta del ciclo aromático como se puede observar en la Figura III.7. Según la sustitución de radicales, como se detalla en la tabla incluida en la Figura III.7, en la nomenclatura se usan los prefijos  $\alpha$ ,  $\beta$ ,  $\gamma$  y  $\delta$  para ambos tipos de compuestos [17].



Figura III.7. Estructura general de tocoferoles (arriba) y tocotrienoles (abajo).

Los tocoles con actividad antioxidante suelen ser referidos como vitamina E, siendo el compuesto más representativo de esta familia el  $\alpha$ -tocoferol [17]. Los compuestos que presentan la función de vitamina E en el aceite de oliva son los tres primeros tocoferoles; siendo el  $\alpha$ -tocoferol el que se presenta en mayor concentración (entre el 52 y el 87% del total de tocoferoles), variando la cantidad de  $\beta$ -tocoferol entre el 15 y el 20%, y el  $\gamma$ -tocoferol entre el 7 y el 23% [17]. Los aceites españoles e italianos presentan un rango de concentración de tocoferoles muy amplio pero, en general, son los aceites griegos los que contienen mayor cantidad de tocoferoles; aunque en cualquier caso, depende mucho de factores ambientales [11].

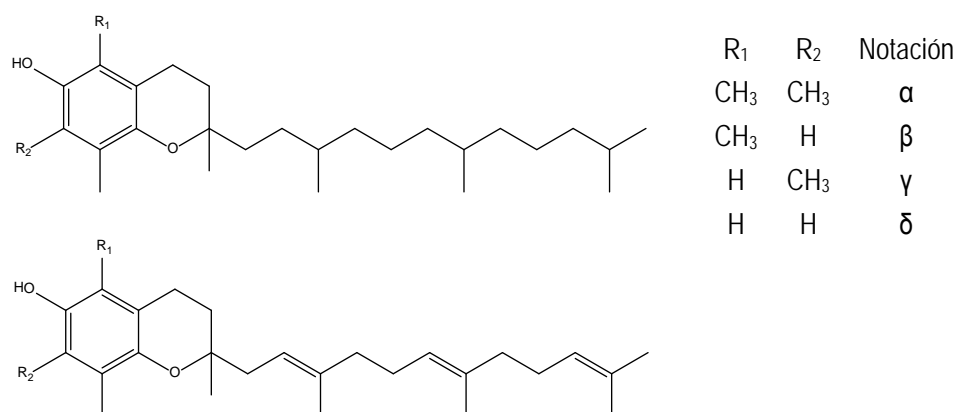

### III.2.3. Compuestos exógenos. Contaminantes.

En el aceite de oliva también pueden encontrarse compuestos indeseados, como los contaminantes. Dichos contaminantes pueden ser transferidos a las aceitunas o al aceite de oliva en las etapas de laboreo, transporte, producción y almacenamiento. Los contaminantes más comúnmente encontrados en aceite de oliva son residuos de plaguicidas (o pesticidas, del inglés *pesticides*), hidrocarburos aromáticos y metales. Entre los residuos de plaguicidas se pueden encontrar las sustancias activas de los productos fitosanitarios, sus metabolitos y productos de degradación. Los hidrocarburos aromáticos son generados por la combustión parcial de los combustibles fósiles y pueden transferirse al aceite por contacto de la aceituna con fugas de combustible durante el transporte a la almazara, o por contaminación ambiental; generalmente se dividen en dos grupos, hidrocarburos aromáticos monocíclicos (MAHs) e hidrocarburos aromáticos policíclicos (PAHs). La presencia de metales pesados en los aceites de oliva se suele atribuir al almacenamiento del mismo en contenedores metálicos no apropiados, que puedan transferir dichos metales al aceite de oliva.

### III.3. Tipos de análisis requeridos en aceite de oliva

El aceite de oliva está sujeto a una regulación internacional que determina las diferentes categorías comerciales en función de la composición química de los aceites. A estos criterios de clasificación se les denomina criterios de calidad y se evalúan siguiendo métodos oficiales que se encuentran validados. El órgano internacional encargado de la elaboración de normas y el establecimiento de los métodos de análisis oficiales es el Consejo Oleícola Internacional (COI), que también colabora con otros organismos internacionales. La norma comercial internacional que rige actualmente las categorías comerciales y los métodos de análisis es la norma COI/T.15/NC No 3/Rev. 11 [38], relacionada con la norma CODEX STAN 33-1981 del Codex Alimentarius [39], y adoptada en la legislación europea en forma de reglamentos [40]. Estas normas recogen, además, los denominados criterios de pureza, que son determinaciones analíticas de ciertos compuestos o familias de compuestos encaminadas a la detección de posibles adulteraciones del aceite de oliva virgen con aceites de inferior calidad y precio de mercado. Por último, la Norma Comercial trata asimismo otros aspectos, como los aditivos

alimentarios, los contaminantes, la higiene, el envasado, la tolerancia en materia de llenado de los envases y el etiquetado.

En la Tabla III.1 se resumen los métodos de análisis oficiales para la determinación de los criterios de calidad y pureza de los aceites de oliva, así como los métodos de referencia de algunas otras determinaciones de interés en este alimento.

**Tabla III.1.** Tabla resumen de métodos oficiales para los parámetros de calidad y pureza en aceite de oliva.

Criterio	Tipo de criterio	Tipo de método analítico	Referencia
Análisis sensorial	Calidad	Cata	[41–43]
Acidez	Calidad	Volumetría ácido-base	[44,45]
Índice de peróxidos	Calidad	Volumetría redox	[46]
Absorbancia a 270 y 232 nm	Calidad	Espectrofotometría	[47–49]
Perfil de ácidos grasos	Pureza	Cromatografía de gases con un detector de ionización de llama (GC-FID)	[50–54]
Perfil y contenido de esteroides	Pureza	Separación de los esteroides por cromatografía en capa fina (TLC) con sílice y determinación por GC-FID	[55,56]
Contenido de estigmastadienos	Pureza	Separación de los estigmastadienos mediante cromatografía preparativa con columna de sílice y determinación por GC-FID	[57–60]
Contenido en ceras	Pureza	Separación de las ceras mediante cromatografía preparativa con columna de sílice y determinación por GC-FID	[61]
Triglicéridos con ECN 42	Pureza	Cromatografía de líquidos (HPLC)	[62,63]
2- monopalmitato de glicerilo	Pureza	Hidrólisis con lipasa pancreática seguida de determinación por GC-FID	[64,65]
Compuestos fenólicos	Otro	HPLC	[66]
Tocoferoles	Otro	HPLC	[67]

### III.3.1. Categorías comerciales de aceite de oliva

El aceite de oliva es el aceite obtenido únicamente del fruto del olivo (*Olea europaea L.*) con exclusión de los aceites obtenidos usando disolventes o procedimientos de reesterificación y de cualquier mezcla con aceites de otro tipo. Como se ha indicado anteriormente, las distintas categorías comerciales vienen definidas por la norma comercial del COI [38]. Según si la obtención del aceite se realiza exclusivamente por medios físicos y mecánicos, o por métodos químicos, se realiza la siguiente clasificación (ver Figura III.8):

- Los aceites de oliva vírgenes son los aceites obtenidos del fruto del olivo únicamente mediante procedimientos mecánicos u otros medios físicos en condiciones, particularmente térmicas, que no produzcan alteración del aceite y que no hayan tenido más tratamiento que el lavado, la decantación, la centrifugación y el filtrado. Dentro de los aceites vírgenes, el aceite de oliva virgen extra es el de mayor calidad, seguido del aceite de oliva virgen. Todos aquellos aceites que no cumplan con los requisitos de calidad establecidos en la normativa para ser encuadrados en alguna de estas dos categorías deben someterse a un proceso de refinado.
- La categoría comercial denominada aceite de oliva responde a un producto que contiene en su mayor parte aceite de oliva refinado, mezclado con un pequeño porcentaje de aceite virgen para que le dé color y sabor.
- El aceite de orujo de oliva es el aceite obtenido mediante tratamiento con disolventes no halogenados u otros procedimientos físicos del orujo de oliva (residuo sólido obtenido tras la extracción del aceite), con exclusión de los aceites obtenidos por procedimientos de reesterificación y de cualquier mezcla con aceites de otra naturaleza. Este aceite debe someterse a un proceso de refinación para poder ser consumido. El aceite de orujo de oliva comercial se corresponde con una mezcla de aceite de orujo de oliva refinado con un pequeño porcentaje de aceite virgen para que le dé color y sabor.



Figura III.8. Tipos de categorías comerciales de aceite de oliva. Las categorías comerciales se representan en color verde, mientras que las categorías que no se comercializan para su consumo directo están marcadas en amarillo.

### III.3.2. Parámetros de calidad

El aceite de oliva puede ser considerado de mayor calidad según un conjunto de parámetros que atienden a la composición. Los parámetros sirven tanto para clasificar los aceites en distintas categorías comerciales como para distinguirlos con mayor o menor calidad dentro de su misma categoría comercial y pueden aportar un valor adicional nutricional, organoléptico y/o económico, son los llamados parámetros de calidad. Los parámetros de calidad del aceite de oliva son la valoración organoléptica, la acidez libre, el índice de peróxidos y la absorbancia a 232 y 270 nm.

Análisis sensorial. Mediante el análisis sensorial o cata [68], se determinan dos de los parámetros que se usan para categorizar el aceite de oliva, la mediana del defecto y la mediana del frutado [38,39]. Haciendo la mediana estadística de los atributos positivos y negativos evaluados por cada uno de los catadores participantes en el panel de cata, se obtienen la mediana del frutado y mediana del defecto, respectivamente [41]. Como

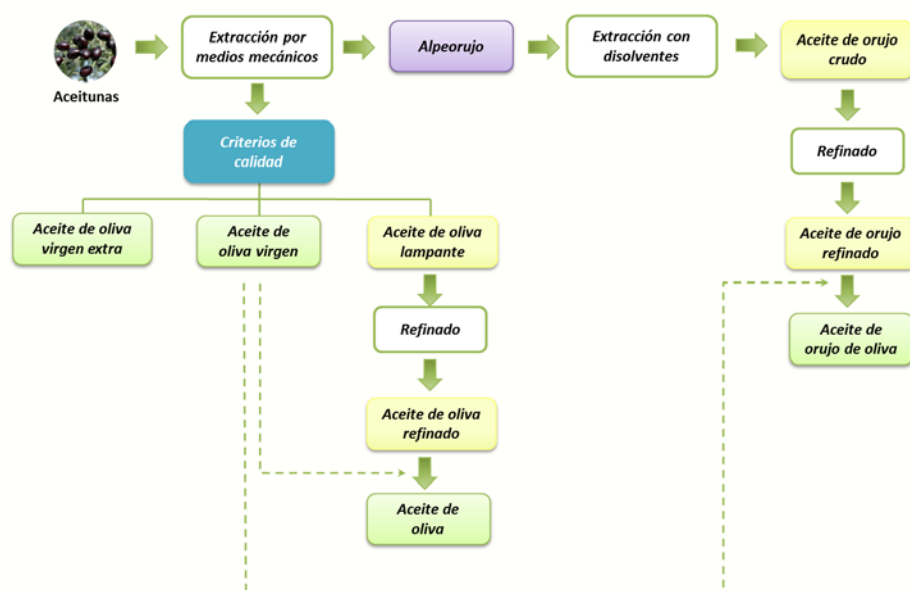
atributos positivos están el amargo, el picante y el afrutado, mientras que los negativos son más numerosos, incluyendo atrojado, rancio, mohoso, quemado, entre otros [41]. También se evalúan otras cualidades como el color, el olor y sabor a otros vegetales (tomate, alcachofa, hierba, plátano,...). Debido a que el análisis sensorial es el resultado de las sensaciones que el catador percibe por los sentidos, es un procedimiento altamente normalizado. En la Tabla III.2 se recoge un listado de las normas internacionales que regulan el procedimiento de cata de los aceites de oliva.

**Tabla III.2.** Normas que regulan el análisis sensorial de los aceites vírgenes.

Aspecto regulado	Norma	Referencias
Formación de catadores	COI/T.20/Doc. No 14/Rev. 4	[69]
Procedimiento de cata	COI/T.20/Doc. No 4/Rev. 1	[41–43]
	COI/T.20/Doc. No 15/Rev. 8 COI Decisión No DEC-14/103-V/2015	
Sala de cata	COI/T.20/Doc. No 6/Rev. 1.	[70]
Vaso de cata	COI/T.20/Doc. No 5/Rev. 1	[71]

Para que un aceite de oliva sea catalogado como “virgen extra” debe presentar una mediana del frutado positiva, y ningún defecto. Un aceite de oliva virgen puede presentar algún defecto, pero el valor de la mediana del defecto debe ser igual o inferior a 3,5 (ver Tabla III.3.).

**Acidez.** La acidez está provocada mayoritariamente por ácidos grasos libres procedentes de la hidrólisis de los triglicéridos. Esta acidez se expresa como gramos de ácido oleico por cada 100 gramos de aceite de oliva, ya que dicho ácido graso es el mayoritario. En la tabla III.3 se resumen, junto con los criterios del análisis sensorial, los límites establecidos en la normativa para la clasificación de las distintas categorías de aceites vírgenes, atendiendo a su acidez libre.

**Tabla III.3.** Atributos organolépticos y límites de acidez libre establecidos para las categorías comerciales de aceites de oliva vírgenes [38].

Categoría comercial	Acidez libre (A)	Mediana del Defecto (D)	Mediana del Atributo Frutado (F)	Venta directa al consumidor
Aceite de Oliva <b>Virgen Extra</b>	$A \leq 0.8$	$D = 0$	$F > 0$	Sí
Aceite de Oliva <b>Virgen</b>	$0.8 < A \leq 2$	$0 < D \leq 2.5$	$F > 0$	Sí
Aceite de Oliva <b>Virgen Corriente</b>	$2 < A \leq 3.3$	1) $2.5 < D \leq 6.0$ 2) $D \leq 2.5$	1) $F > 0$ 2) $F = 0$	En algunos países fuera de la UE
Aceite de Oliva <b>Virgen Lampante</b>	$3.3 \geq A$	1) $D > 6.0$ 2) $D > 2.5$	1) $F > 0$ 2) $F = 0$	No. Debe ser refinado

El método oficial para determinar la acidez libre de un aceite es una volumetría ácido-base usando una disolución etanólica de hidróxido potásico como agente valorante y fenolftaleína como indicador [44,45]. En la bibliografía se pueden encontrar algunos métodos alternativos para determinar la acidez de los aceites de oliva, basados en la detección del punto final de la volumetría mediante técnicas electroanalíticas como la potenciometría, conductimetría o voltamperometría [72–74]. Por otra parte, también se han desarrollado métodos para la determinación de acidez basados en el uso de técnicas espectroscópicas, como la espectroscopía Raman [75] o la espectroscopía infrarroja [76].

Índice de peróxidos. El índice de peróxidos sirve para determinar el grado de oxidación del aceite de oliva y se expresa en miliequivalentes de oxígeno activo por kg de aceite (meq  $O_2$ /kg aceite). El método oficial es una volumetría rédox en la que el aceite se trata con yoduro potásico y el yodo generado en la reacción se valora con una disolución de tiosulfato sódico [46]. Al igual que para la determinación de la acidez, el punto final de la volumetría para la determinación del índice de peróxidos se podría detectar mediante potenciometría, eliminando el error generado al usar el viraje de un indicador como punto final de la valoración.

Coefficiente de extinción molar a 232 y 270 nm. La determinación del coeficiente de extinción molar (K) a estas longitudes de onda también supone una medida de la oxidación de los aceites o de cambios debidos al proceso de refinado. A estas longitudes de

onda absorben los dienos y trienos conjugados. El coeficiente de extinción molar se calcula haciendo la medida espectrofotométrica a 232 y 270 nm de una disolución de una concentración de 1% (masa/volumen) de aceite en ciclohexano, en una cubeta de 10 mm de espesor [47].

En la Tabla III.4 se resumen los valores admitidos para el índice de peróxidos y los coeficientes de extinción molar para las distintas categorías de aceite de oliva [38].

Tabla III.4. Máximo de contenido en peróxido para las distintas categorías de aceite de oliva.

Aceite	Aceites de oliva vírgenes	Aceite de oliva refinado	Aceite de oliva	Aceite de orujo de oliva refinado	Aceite de orujo de oliva
Índice de peróxidos (meq O <sub>2</sub> /kg aceite)	≤ 20	≤ 5	≤ 15	≤ 5	≤ 15
K <sub>270</sub> (Absorbancia a 270 nm)	≤ 0.22/≤ 0.25/≤ 0.3 (virgen extra/ virgen/ corriente)	≤ 1.25	≤ 1.15	≤ 2.00	≤ 1.70
ΔK (Diferencia de la absorbancia a 270 nm y a 230 nm)	≤ 0.01	≤ 0.16	≤ 0.15	≤ 2.00	≤ 0.18

### III.3.3. Criterios de pureza

Por otro lado, los criterios de pureza pretenden discernir si un aceite de oliva ha sido adulterado, bien con otros aceites vegetales o bien adicionando otro aceite de una categoría inferior. Las determinaciones que generalmente se llevan a cabo están resumidas en la tabla III.1 e incluyen la composición de triglicéridos, el perfil de ácidos grasos y esteroides, la cuantificación del contenido en ceras, esteroides, estigmastadienos, etc [38]. En la Tabla III.5. se recogen los contenidos máximos y mínimos de una serie de componentes minoritarios del aceite de oliva.

**Tabla III.5.** Contenidos máximos y mínimos de distintos componentes minoritarios del aceite de oliva en todas sus categorías.

Aceite	Contenido mínimo en esteroides (g/kg)	Contenido máximo en ceras (g/kg)	Contenido máximo en estigmastadienos (g/kg)
Aceites de oliva vírgenes	1.0	0.25	0.00015
Aceite de oliva refinado	1.0	0.35	0.00015
Aceite de oliva	1.0	0.35	0.00015
Aceite de orujo de oliva refinado	1.8	0.35	0.00015
Aceite de orujo de oliva	1.6	0.35	0.00015

Los métodos de referencia para la determinación de los criterios de pureza, se basan en su mayoría en el uso de la cromatografía de gases (GC). En esta técnica, los compuestos de interés (ácidos grasos, esteroides, estigmastadienos, ceras...) son separados en una columna capilar mediante un gradiente de temperatura [77]. Por lo tanto, se requiere que los compuestos a analizar sean volátiles o bien sean "transformados" en compuestos volátiles mediante una reacción de derivatización, como ocurre para obtener el perfil de ácidos grasos del aceite de oliva [78].

Ácidos grasos. En la norma [38] se detallan el tipo de ácidos grasos que cabe esperar en un aceite de oliva puro, y el porcentaje de los mismos. La presencia de otros ácidos grasos o la variación en el porcentaje relativo de los mismos indicaría la adulteración del aceite de oliva con otros aceites vegetales. El método de referencia para el análisis de ácidos grasos usa cromatografía de gases, lo que requiere una reacción de derivatización de estos compuestos, como se ha mencionado anteriormente. Por lo general, los ácidos grasos se hacen reaccionar con una base fuerte, NaOH o KOH, disuelta en un alcohol, metanol (MeOH) o etanol (EtOH), para obtener ésteres metílicos o etílicos volátiles, respectivamente. Existen además una serie de métodos alternativos descritos en bibliografía que no requieren de la etapa de derivatización. Algunos de estos métodos se basan en el uso de resonancia magnética nuclear (RMN) [79,80]. La principal ventaja



de los métodos alternativos que usan espectroscopía frente a los métodos oficiales basados en cromatografías, es la velocidad de análisis de estos métodos debido a que no se necesita hacer una derivatización previa necesaria para generar derivados volátiles de los ácidos grasos. Además, se reduce considerablemente el tiempo de análisis frente a la cromatografía con derivatización previa.

Esteroles. La composición y concentración de esteroides puede usarse para determinar si un aceite de oliva ha sido adulterado, especialmente con aceites de semillas, cuya cantidad de esteroides es superior a la de los aceites de oliva [81]. El método oficial para la determinación de ésteres y alcoholes recurre a la extracción de los esteroides y dialcoholes triterpénicos, obteniendo primero el material insaponificable que será previamente cromatografiado para aislar los compuestos de interés. En este caso, el interés en mejorar este método se ha centrado en evitar o sustituir la cromatografía preparativa y usar la cromatografía líquida acoplada a espectrometría de masas [82–87].

Ceras. El análisis del contenido en ceras puede ayudar a detectar aceites de orujo y refinados. El método oficial [61] consiste en la separación de las ceras en una columna de sílice y posterior determinación del contenido en ceras mediante GC con columna capilar y analizador de ionización de llama (FID). Como en el caso anterior, se han propuesto métodos alternativos en los que se intenta en la medida de lo posible evitar o automatizar la cromatografía preparativa y la cromatografía de gases. Para ello aparecen en bibliografía dos aproximaciones, una con una cromatografía preparativa acoplada en línea a la cromatografía de gases analítica [88,89] y otra que es usar una cromatografía preparativa en fase normal [90].

Estigmastadienos. Los estigmastadienos se producen por la deshidratación de esteroides en procesos térmicos, pueden usarse para detectar aceites refinados. Este es sin duda el parámetro menos estudiado, pues solo se ha desarrollado un solo método alternativo al oficial en el que se aprovecha el potencial que la espectrometría de masas proporciona [91].

ECN 42. Otro parámetro que nos puede servir para identificar adulteraciones en el aceite, como añadir aceites de semilla, es la determinación del ECN 42. Este es la diferencia existente entre el valor teórico de los triglicéridos de número de carbonos equivalente a 42, calculado a partir de la composición en ácidos grasos, y los resultados analíticos obtenidos por determinación en el aceite mediante cromatografía líquida de alta eficacia (HPLC) [62]. Los valores aceptables son de 0.2 para aceites vírgenes, 0.3 para oliva y oliva refinado y 0.5 para orujo.

### III.3.4. Determinación de residuos de plaguicidas en aceite de oliva

Los residuos de plaguicidas son compuestos exógenos del aceite de oliva que pueden llegar a ser muy nocivos para la salud del consumidor. Estos se generan durante las prácticas agrícolas necesarias para el buen rendimiento del olivar y que, aunque su uso sea legal y se respeten los tiempos de espera, pueden quedar en la aceituna y transferirse al aceite durante su elaboración. A pesar de ello, no existe una legislación específica para la presencia de residuos de plaguicidas en aceite de oliva.

El Reglamento (CE) N° 396/2005 [92] establece los límites máximos de residuos (MRLs) armonizados para todos los países de la UE. En el anexo VI del citado reglamento se deberán establecer los factores de transformación (dilución o concentración) a aplicar a los MRLs establecidos para las materias primas para obtener los MRLs correspondientes a productos procesados, como el aceite de oliva. Hasta la fecha, el anexo VI no ha sido publicado y por defecto se aplica el mismo MRL a los productos procesados que a la materia prima, o lo que es lo mismo, se establece un factor de transformación igual a la unidad. No obstante, la UE establece un control oficial sobre los productos comercializados en la unión, y a partir del trienio 2015-2017 estableció un factor de transformación igual a 5 para el aceite de oliva [93]. El reglamento actual para el control oficial del trienio 2017-2019 distingue un factor de procesado de 5 para plaguicidas liposolubles y un factor de procesado igual a 1 para plaguicidas hidrosolubles [94]. El Codex Alimentarius establece como criterio general que se definan como liposolubles aquellos compuestos con un coeficiente de partición octanol-agua mayor que 3 ( $\log K_{ow} > 3$ ) [95].

La determinación de residuos de plaguicidas en alimentos generalmente se realiza a través de métodos multiresiduo que implican una separación, bien por cromatografía de gases, o bien por cromatografía líquida.

#### **III.4. Técnicas analíticas aplicables a determinaciones en aceite de oliva**

Uno de los principales motivos por los que se han buscado alternativas a los métodos cromatográficos oficiales, los cuales son bastante sensibles y reproducibles, es la eliminación de la etapa de derivatización. Los métodos alternativos para la determinación de ácidos grasos que se han propuesto se basan en la espectroscopía, mientras que para la determinación de componentes minoritarios como esteroides y ceras se han propuesto métodos basados en el uso de cromatografía líquida (HPLC). En este tipo de cromatografía, los analitos se separan en una columna con un sorbente polar (fase normal) o apolar (fase reversa) que interacciona con el analito reteniéndolo hasta ser eluido progresivamente por la fase móvil, que normalmente es una mezcla de dos o más disolventes y cuya composición va variando usando un cierto gradiente. Para eluir a los analitos inmovilizados sobre la superficie del sólido se utiliza una elución en gradiente a alta presión, de modo que la polaridad de la fase móvil va cambiando [96].

A continuación se describe brevemente el fundamento de las técnicas analíticas empleadas en la presente tesis doctoral:

##### **III.4.1. Análisis por inyección en flujo (FIA)**

En esta tesis doctoral se proponen diversos métodos basados en el análisis en flujo como alternativa a los métodos de referencia, dada su alta reproducibilidad, bajo coste y posibilidad de implementación en almazaras. Algunos de los fundamentos del análisis en flujo se exponen a continuación.

El Análisis por Inyección en Flujo (FIA por sus siglas en inglés) es un sistema en flujo continuo no segmentado. Este sistema fue descrito por primera vez a mediados de los setenta por Ruzicka y Hansen [97]. Para el desarrollo de esta metodología se sirvieron del equipo [97,98] que se aprecia en la Figura III.9.

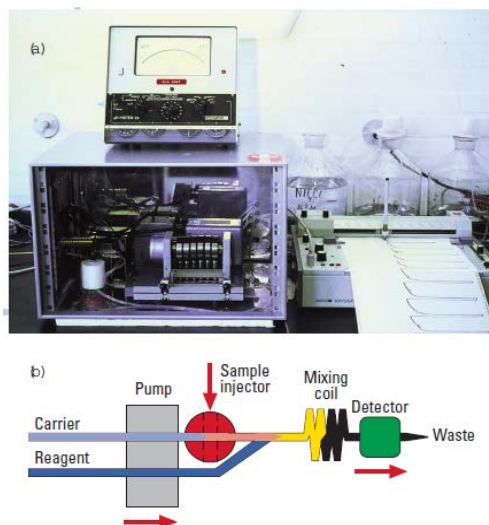

**Figura III.9.** Figura tomada de [98] donde se muestra el montaje FIA usado por sus inventores y el esquema correspondiente al mismo.

El nombre de esta metodología viene dado por el uso de una jeringuilla hipodérmica para la introducción de la muestra en el primer sistema FIA [97] y que por razones históricas se ha mantenido, aunque hoy en día se usen válvulas de 6 vías u otros sistemas de introducción de volumen computarizados.

Entre las ventajas que tiene este sistema caben destacar su gran versatilidad, bajo coste, rapidez, reproducibilidad, robustez, y sencillez de montaje y manejo [99]. Estas características lo convierten en una valiosa herramienta de trabajo en laboratorios de rutina donde la rapidez, robustez y el bajo coste de análisis son auténticos retos a conseguir. También es posible el uso de este sistema como prototipo de pequeños instrumentos portátiles de análisis in-situ. Estos sistemas también ofrecen una alta selectividad ya que en la mayoría de los casos, en el corto espacio de tiempo en el que se toma la medida, las reacciones paralelas indeseables no llegan a desarrollarse [100].

No obstante, los sistemas FIA también tienen algunas desventajas: los métodos FIA en general son ligeramente menos sensibles que los manuales análogos. Esto se debe a dos razones: la dilución o dispersión física que sufre la muestra al ser introducida en el

sistema en flujo y el hecho de que las reacciones no hayan alcanzado el equilibrio químico en el momento de la medida, hacen que la señal no sea todo lo intensa que cabría si se alcanzara dicho equilibrio. Una posible solución para mejorar la sensibilidad es el empleo de un soporte sólido para permitir la retención e inherente preconcentración de uno o más analitos o derivados de los mismos en la zona sensora [101], lo que se denomina optosensores en flujo.

#### III.4.1.1. Componentes básicos de los sistemas FIA

Como se puede apreciar en la Figura III.9, un sistema FIA básico está constituido por una serie de componentes esenciales [100] aunque el número de estos componentes varíe según las necesidades del análisis. Estos componentes básicos son:

Unidad de propulsión, que debe establecer un flujo de caudal tan constante y regular como sea posible de los distintos canales del sistema (portador y/o reactivo/s y muestra). Esta propulsión puede ser ejercida por un sistema de presión gaseosa, la fuerza de la gravedad o una bomba peristáltica, siendo este último el método más usado [102-109].

Sistema de inyección, que permite insertar o introducir en el flujo del sistema un volumen concreto de forma exacta de manera que sea perfectamente reproducible y que no haya que interrumpir el flujo. Estos sistemas han evolucionado desde una simple jeringuilla hipodérmica [97] a modernas válvulas solenoides computerizadas (usadas en el análisis en flujo multiconmutado, MCFIA) [109,110] y robots [103] pasando por las clásicas válvulas de seis vías [102,108].

Zona de tubo, que es donde tiene lugar el transporte (tubos rectos para minimizar el uso de reactivos y muestras) y, dependiendo del sistema, algunos procesos adicionales. Para estos procesos los tubos se disponen en forma de serpentín (reactor/mezclador), se rellenan de algún material inerte o activo químicamente (redox, cambio iónico, etc.), o se intercalan cámaras de mezcla.

Detector: el detector debe permitir la medida continua de una propiedad de la muestra o de un producto de reacción de ésta, proporcionando información cualitativa y cuantitativa. Los detectores utilizados en sistemas FIA pueden ser varios tipos, siendo los más utilizados los detectores ópticos [111], que son los que se emplearán en la presente tesis doctoral..

*Espectrofotometría de absorción molecular UV-visible.* Para la medida en este tipo de detectores, es necesario el uso de una celda de flujo, que es incorporada a un instrumento para medir y registrar la señal transitoria de la medida del análisis. Para medidas en la zona de absorción ultravioleta, la celda debe ser de cuarzo. La medida puede realizarse de forma directa, registrando la absorbancia de los analitos de interés o de sus productos de reacción; o bien puede realizarse una medida indirecta, registrando el descenso en la absorbancia de un reactivo coloreado que reaccione con los analitos [112].

*Luminiscencia molecular (fluorescencia, fosforescencia y quimioluminiscencia).* La espectroscopía de luminiscencia molecular también es muy utilizada para el desarrollo de sistemas FIA [113]. La luminiscencia molecular se basa en la emisión de energía en forma de radiación electromagnética (UV, visible o infrarroja cercana) por parte de moléculas, como resultado de la transición desde un estado electrónicamente excitado a un estado de menor energía, normalmente el estado fundamental [113]. En el fenómeno de fluorescencia molecular, el espín electrónico permanece inalterado, o lo que es lo mismo, la transición electrónica se produce hacia un estado singlete; por el contrario, el fenómeno de fosforescencia molecular, la transición electrónica se produce hacia un estado triplete, en el que el espín electrónico se invierte. Finalmente, la quimioluminiscencia se define como la producción de radiación electromagnética como resultado de una reacción química, de forma que alguno de los productos de reacción se obtiene en el estado excitado y emite luz al volver a su estado fundamental.

Existen numerosas aplicaciones de la fluorescencia y la quimioluminiscencia como sistemas de detección en métodos FIA [113–117]. El reactivo más utilizado con diferencia en los métodos quimioluminiscentes es el luminol, que reacciona con compuestos oxidantes como el peróxido de hidrógeno, el ion superóxido y otras especies reactivas

de oxígeno en medio básico y en presencia de un metal que actúa como catalizador de la reacción (generalmente metales de transición como Co(II), Cu(I), Fe(II) y Fe(III), Ti(IV), Cr(III)). También se ha utilizado la reacción contraria, es decir, aquella en la que el analito se oxida y el reactivo se reduce, para la detección mediante quimioluminiscencia directa; en este caso, uno de los reactivos más utilizados es el permanganato potásico ( $\text{KMnO}_4$ ), que actúa como oxidante en medio ácido, siendo muy útil para la determinación de compuestos fenólicos y compuestos con grupos amino [113].

#### III.4.1.2. Sistemas FIA multiconmutados (MCFIA)

Los sistemas multiconmutados (MCFIA) son muy similares a los sistemas FIA tradicionales pero con una diferencia sustancial, el empleo de válvulas solenoides de tres vías [118,119]. Cada una de las válvulas solenoides de tres puertos implementada en el sistema actúa como un conmutador independiente; esto conlleva grandes ventajas frente al uso de la clásica válvula rotatoria de seis vías de los sistemas FIA: volumen de inyección basado en el tiempo de apertura de la válvula y no en el volumen del bucle, menor consumo de muestra, mayor reproducibilidad y mayor nivel de automatización.

Como se ha mencionado antes la esencia del MCFIA es el empleo de válvulas solenoides cuyo esquema de funcionamiento se presenta en la Figura III.10.



Figura III.10. Esquema de la válvula solenoide de 3 vías [118].

Cada válvula puede adoptar dos posiciones distintas, estando por defecto en la posición OFF. En esta posición el solenoide conectado al generador está relajado al no recibir energía, por lo que la armadura (en forma de T invertida) es empujada hacia el fondo, circulando la disolución hacia el detector. Cuando se le transmite al solenoide un impulso eléctrico, la armadura es atraída hacia arriba, bloqueando la salida 0 hacia el detector y siendo la disolución dirigida hacia la salida 1; esta es conocida como posición ON. Generalmente, en la línea por la que fluye la disolución portadora se conecta la posición 0 de la válvula hacia el detector, para que fluya continuamente sin necesidad de aplicar corriente a la válvula. Por el contrario, las líneas por las que fluyen la muestra y los reactivos se suelen conectar de forma inversa, de forma que solo son introducidos hacia el detector cuando la válvula se activa (posición ON), y el volumen inyectado es proporcional al tiempo en el que permanece en esta posición (duración del pulso eléctrico). La salida 0 de las válvulas situadas en las líneas de muestra y reactivos se conecta hacia una zona de tubo que vuelve hacia el recipiente que contiene la disolución, de forma que cuando estas válvulas se encuentran en posición 0, la muestra y los reactivos son recirculados hacia los recipientes que las contienen, disminuyendo su consumo y la generación de residuos.

Comparando los sistemas FIA clásicos con los MCFIA se pueden apreciar una serie de ventajas:

- Miniaturización. El reducido tamaño de las válvulas solenoides y de las interfases electrónicas permiten desarrollar equipos pequeños e instrumentación portátil para realizar análisis *in situ*.
- Menor consumo de muestra y reactivos. Esto es debido a que las distintas disoluciones son recirculadas a sus respectivos recipientes cuando no es necesario su uso en lugar de estar circulando continuamente a través del sistema hacia el desecho.
- Aumento de la reproducibilidad. Esto es consecuencia a que la apertura de las válvulas es controlada por un software informático y no por un operador.
- Economía y sencillez. Las válvulas solenoides son más baratas que las rotatorias de seis puertos convencionales; su apertura se produce por un pulso eléctrico (normalmente de 12V y 100 mA).

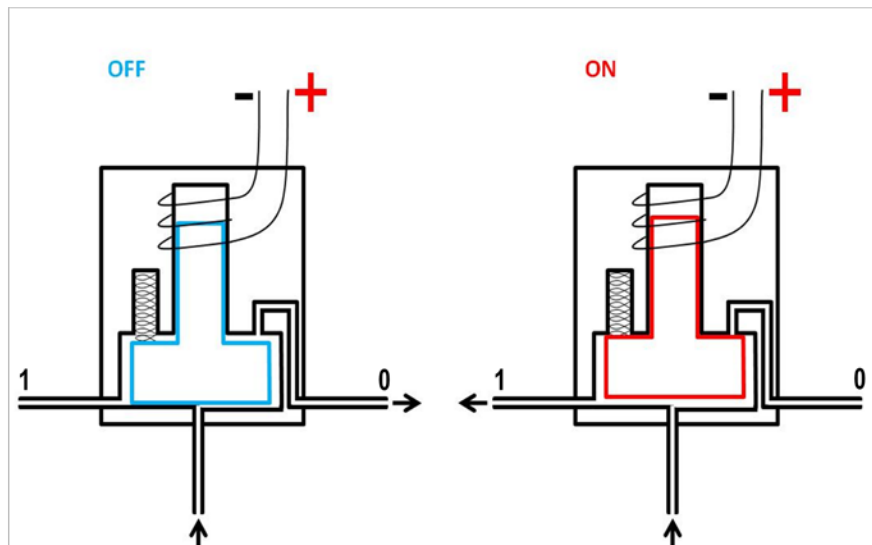

- Versatilidad. Mediante la multiconmutación es posible cambiar las variables que inciden directamente en los perfiles de dispersión (volúmenes insertados, tiempos de reacción, etc.) sin tener que alterar físicamente el montaje.
- Ampliación de las modalidades de análisis en flujo. Debido al control computarizado de los sistemas MCFIA se han podido desarrollar modalidades de flujo detenido, confluencia de zonas, penetración de zonas y muestreo de zonas. Además de procedimientos automáticos para determinaciones multiparamétricas y montajes multi-canal de gran complejidad que pueden ser controlados de forma sencilla.

Sin embargo, también presenta algunas desventajas frente al FIA. La primera es que los equipos no están disponibles comercialmente, de modo que en los trabajos relacionados con esta técnica se reporta el uso de hardware y software de fabricación propia; sin embargo la sencillez de ambos elementos permite su desarrollo sin demasiada dificultad.

#### III.4.1.3. El análisis por inyección en flujo aplicado al aceite de oliva

Dada la versatilidad y potencialidad que ofrece el FIA, se han descrito metodologías para la determinación de diversos parámetros en aceite de oliva, a pesar de las dificultades intrínsecas que vienen impuestas por la hidrofobicidad de esta compleja matriz. Quizás por esta razón el número de trabajos FIA publicados sobre análisis de componentes del aceite de oliva relacionados con la calidad o pureza del mismo es muy escaso. En la Tabla III.6 se recoge algunos de estos trabajos hallados en bibliografía sobre análisis en flujo para la determinación de distintos parámetros en aceite de oliva.

**Tabla III.6.** Metodologías de análisis en flujo aplicadas a distintos tipos de análisis en aceite de oliva.

Parámetro de calidad/Criterio de pureza del aceite de oliva a determinar	Método de análisis en flujo empleado	Referencia/s
Acidez	FIA	[120]
Acidez	MCFIA	[109]
Índice de peróxidos	FIA	[102]
Contenido en fenoles	FIA	[121]
Contenido en fenoles	MCFIA	[121]

En esta tesis se desarrollarán nuevos métodos basados en el análisis en flujo multiconmutado (MCFIA) para determinación de varios parámetros del aceite de oliva, que pueden ser incorporados a laboratorios de rutina y podrían ser de gran interés para su implementación en el control *in situ* en almazaras.

### III.4.2. Espectrometría de masas

La espectrometría de masas es una herramienta muy valiosa y de un gran potencial en el campo de la Química Analítica. Es una técnica muy sensible que, acoplada a otras técnicas como las cromatográficas, ofrece un potencial analítico extraordinario para análisis multicomponente en matrices de muy diversa naturaleza y complejidad. En el campo de la seguridad alimentaria, hoy en día esta herramienta resulta imprescindible para abordar análisis de multiresiduos en alimentos. En esta tesis se evaluará la posibilidad de mejorar las prestaciones actuales de los equipos de espectrometría de masas (acoplados o no a cromatografía líquida) para determinación de componentes endógenos y contaminantes.

La espectrometría de masas detecta las distintas especies químicas en función de su relación masa/carga ( $m/z$ ) cuando estas especies son ionizadas. Este proceso de ionización puede generar, dependiendo de las condiciones, una mayor o menor fragmentación de las moléculas ionizadas; estos fragmentos son total o parcialmente ionizados e, incluso, fragmentados [122].

Un espectrómetro de masas consta de tres partes esenciales:

- 1) Fuente de ionización
- 2) Analizador de iones, también conocido como analizador de masas.
- 3) Detector

Se podría hablar de una cuarta parte previa a la fuente de ionización que es el sistema de introducción de la muestra, aunque solo se considera cuando se acopla la espectrometría de masas a la cromatografía de gases (GC/MS); de líquidos (LC/MS) o, en menor medida, a electroforesis capilar (CE/MS).

En estos instrumentos, tanto el analizador de masas como el detector se encuentran a alto vacío ( $10^{-4}$  a  $10^{-8}$  torr), lo cual es necesario para evitar que los iones que son conducidos a través del mismo colisionen con las partículas y especies que hay presentes en la atmósfera del laboratorio. Como se puede apreciar en el esquema general de la Figura III.11, dependiendo del modo de introducir la muestra, la fuente de ionización puede estar a alto vacío o a presión atmosférica; en este segundo caso se habla de técnicas de ionización a presión atmosférica (API, por sus siglas en inglés).



Figura III.11. Esquema general de un espectrómetro de masas.

Debido a que es el tipo de analizador lo que va a diferenciar la obtención de los resultados a partir de los iones que se generen en la fuente, se comenzará por describir cuáles son y en que basan su funcionamiento. Una vez son ionizadas las distintas especies presentes en la muestra, incluyendo tanto analitos como otros compuestos presentes en la matriz, son transportados al analizador. Es en esta parte del equipo donde los iones son separados según su relación masa/carga ( $m/z$ ), en función de distintos principios, aunque todos utilizan campos eléctricos y/o magnéticos. En la actualidad, en química analítica se utilizan mayoritariamente tres tipos de analizadores:

- 1) Analizador cuadrupolar (Q de *quadrupole*)
- 2) Analizador de tiempo de vuelo (TOF, por sus siglas en inglés)
- 3) Trampa de iones orbital u Orbitrap

Existen varios tipos de analizadores [122] en el mercado, atendiendo al principio que separa los iones en función de su  $m/z$ , los cuales se muestran en Tabla III.7. En función del principio usado para la detección de los iones, estos llegarán simultánea o secuencialmente al detector. También atendiendo al principio en que se base el analizador de masas podremos obtener una baja o una alta resolución, es decir, una menor o mayor exactitud de masa atendiendo al número de decimales de la relación masa/carga de los iones que el espectrómetro de masas es capaz de ofrecer.

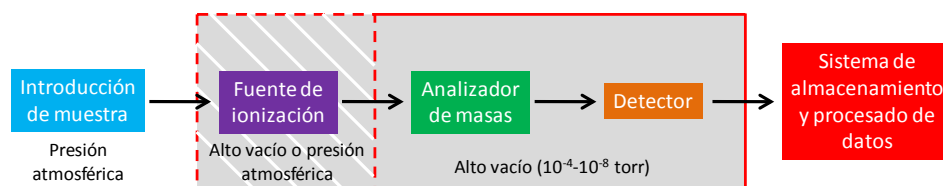
Se define poder de resolución (R) como la relación entre masa nominal (m) y la diferencia de masa entre dos picos adyacentes que están resueltos ( $\Delta m$ ), según la siguiente ecuación:

$$R = \frac{m}{\Delta m}$$

En ocasiones se usa la media entre los dos picos resueltos como masa nominal m. Dos picos se consideran separados cuando la altura del valle que hay entre ellos es superior a una determinada fracción. Generalmente, se considera que un instrumento es de alta resolución si  $R > 5000$ , y de baja resolución, si  $R < 5000$ .

Tabla III. 7. Tipos de analizadores de masas.

Tipo de analizador	Siglas	Principio de separación	Llegada de los iones al detector	R	Acoplamiento
Sector eléctrico	E ó ESA	Energía cinética	Simultánea	Baja	GC
Sector magnético	B	Momento magnético	Secuencial	Baja	GC
Cuadrupolo Triple cuadrupolo	Q QqQ	m/z (estabilidad de la trayectoria)	Secuencial	Baja	GC, LC y CE
Trampa de iones tridimensional	IT	m/z (frecuencia de resonancia)	Simultánea	Baja	GC, LC y CE
Trampa de iones bidimensional o lineal. Cuadrupolo de trampa de iones lineal	LIT QqLIT	m/z (frecuencia de resonancia)	Simultánea	Baja	LC y CE
Tiempo de vuelo Cuadrupolo de tiempo de vuelo	TOF QTOF	Velocidad (tiempo de vuelo)	Simultánea	Alta	GC, LC y CE
Resonancia de ión-ciclotrón por transformada de Fourier	FT-ICR	m/z (frecuencia de resonancia)	Simultánea	Alta	LC y CE
Orbitrap por transformada de Fourier	FT-OT	m/z (frecuencia de resonancia)	Simultánea	Alta	LC y CE

### III.4.2.1. Análisis directo y acoplamiento de la espectrometría de masas a técnicas separativas

Actualmente, la mayoría de los métodos analíticos en los que se emplea espectrometría de masas, ésta está acoplada con técnicas separativas, de modo que se pueden determinar simultáneamente las concentraciones individuales de una mezcla de analitos de interés, por ejemplo, para la determinación de parámetros de pureza del aceite de oliva u otros alimentos, que permitan la detección de adulteraciones. Indudablemente, una de las piezas clave del acoplamiento de esta técnica con la cromatografía de líquidos (LC-MS), la cromatografía de gases (GC-MS) y la electroforesis capilar (CE-MS) es la interfase, ya que es en esta parte donde se localiza la fuente de ionización, y de la eficiencia de la ionización depende en gran medida la sensibilidad del análisis. En la Tabla III. 8 aparecen resumidas las aplicaciones de las fuentes de ionización más comunes.

Para el acoplamiento GC/MS, las fuentes de ionización suelen estar a vacío, mientras que para el acoplamiento LC/MS y CE/MS las fuentes más usadas son las que trabajan a presión atmosférica (API – *Atmospheric pressure ionization*). La principal diferencia entre las fuentes API es el principio en el cual se basan para conseguir la ionización de los analitos, lo que conlleva el uso de cada una de ellas en distintas aplicaciones. Las ventajas de estas fuentes se pueden resumir en cuatro puntos [123]:

- 1) Permiten trabajar con los volúmenes de líquido que se utilizan normalmente en LC.
- 2) Son adecuadas para el análisis de compuestos típicos de LC (no volátiles, polares y térmicamente inestables).
- 3) Son sensibles, llegándose a alcanzar límites de detección comparables a los que pueden ser obtenidos en GC-MS.
- 4) Son robustas y relativamente fáciles de manejar.

Tabla III.8. Tipos de fuentes de ionización comunes en el acoplamiento de LC/MS, GC/MS y CE/MS.

Tipo de fuente	Siglas	Muestra	Analitos	Acoplamiento
Impacto electrónico	EI	Gaseosa Líquida	Apolares y media polaridad. Bajo peso molecular	GC
Ionización química	CI	Gaseosa Líquida	Apolares y media polaridad. Bajo peso molecular	GC
Electrospray	ESI	Líquida	Media polaridad. Peso molecular medio-alto	LC y CE
Ionización química a presión atmosférica	APCI	Gaseosa Líquida	Media polaridad. Peso molecular medio	GC, LC y CE
Fotoionización a presión atmosférica	APPI	Líquida	Baja y media polaridad. Peso molecular medio	LC

En la última década se ha incrementado el interés por el desarrollo de métodos basados en espectrometría de masas sin separación previa de los analitos, cada vez más rápidos y que requieran un menor tratamiento de la muestra. Así, la espectrometría de masas con ionización en condiciones atmosféricas (AIMS – *Ambient ionization mass spectrometry*) ha experimentado un gran desarrollo en los últimos años [124,125]. Esta técnica permite el análisis de muestras en distintos estados de agregación, mediante la desorción de los analitos de la superficie de las mismas. La desorción de los analitos de la superficie de las muestras puede llevarla a cabo la propia fuente de ionización, o bien puede tratarse de una desorción térmica por calentamiento de la superficie de soporte, o una ionización asistida por láser. Las técnicas de ionización en condiciones ambientales se pueden clasificar en dos grandes grupos: aquellas basadas en una ionización mediante electrospray (*ESI-like*) y aquellas basadas en una ionización química a presión atmosférica (*APCI-like*) [125,126]. En las técnicas basadas en ESI, aunque el proceso de desorción puede variar, en el proceso de ionización los iones son desorbidos de la muestra y transportados al espectrómetro de masas como pequeñas gotas de disolvente cargadas en fase gaseosa. En este grupo, las fuentes de ionización más representativas son DESI (Desorption electrospray ionization) y PS (*Paper spray*). Por otro lado, las técnicas basadas en APCI involucran el uso de una descarga eléctrica que da lugar a la ionización, por lo que también se suelen denominar como técnicas basadas en la generación de un plasma. En este segundo grupo podemos destacar fuentes como DART (*Direct analysis on real time*), LTP (*Low -temperature plasma*) y DBDI (*Dielectric barrier discharge ionization*).

La espectrometría de masas con ionización en condiciones ambientales ha despertado un gran interés en el análisis de alimentos, especialmente en el campo de la seguridad alimentaria y el análisis de residuos de plaguicidas [127]. En esta tesis doctoral se explora el potencial de las técnicas PS y LTP para el análisis en condiciones ambientales del aceite de oliva.

#### III.4.2.2. Fuentes de ionización convencionales

A continuación se exponen los fundamentos de las principales fuentes API como son ESI, APCI y APPI. Cada una de ellas se puede emplear para analitos con distintas características químicas y físicas como se puede ver en la Figura III.12.



Figura III.12. Rango de aplicación de las fuentes API en función de la polaridad y el peso molecular del analito.

**Electrospray (ESI).** Es la fuente de ionización más usada en LC-MS. Se empezó a utilizar en espectrometría de masas entre las décadas de los 70 y los 80 [128,129]. Se basa en la aplicación de un fuerte campo eléctrico a presión atmosférica a un líquido que fluye a través de un capilar metálico (aguja de nebulización) con un caudal muy bajo (1–1000  $\mu\text{L}/\text{min}$ ). Este campo eléctrico se genera aplicando una diferencia de potencial entre la aguja de nebulización y un electrodo cilíndrico que la rodea separado de dicha aguja a una distancia de entre 0.3 - 2 cm. El campo eléctrico generado provoca la acumulación de carga en la superficie del líquido que se encuentra al final de la aguja de

nebulización, de tal manera que se produce la sobreacumulación de cargas en la superficie del líquido.

Si se está trabajando en modo positivo, la acumulación de cargas en la superficie es de cargas positivas mientras que en el interior del líquido se acumulan cargas negativas, en modo negativo se produce el efecto contrario. Cuando se sobrecarga la superficie por encima del total de cargas que puede soportar, límite de Rayleigh, este líquido se divide en gotas más pequeñas, lo que produce que el mismo número de cargas se divida en una mayor superficie; este fenómeno se denomina explosión coulombiana. De forma coaxial es inyectado un gas a un caudal muy bajo, lo que permite que la dispersión del spray sea limitada en el espacio. A continuación, las pequeñas gotas pasan a través de una cortina de gas inerte (generalmente  $N_2$ ) a alta temperatura para eliminar gran parte de las moléculas de disolvente, de forma que disminuye el tamaño de las gotas y aumenta la densidad de carga en su superficie. Finalmente, se produce la desolvatación de los iones que pasan a formar una fase gaseosa. Una vez los iones están desolvatados, son atraídos hacia el interior de un capilar de polaridad opuesta a la de los iones debido a interacciones electroestáticas. A través del interior de este capilar los iones son guiados hacia el analizador. En modo positivo se forma iones protonados, generalmente monoprotonados  $[M + H]^+$  y, comúnmente, aductos de  $Na^+$ ,  $K^+$  y  $NH_4^+$ ; en modo negativo, lo que se suele dar es la desprotonación  $[M - H]^-$ . Estos procesos se representan en la Figura III.13. Ciertos analizadores, como los TOF, usan fuentes ESI duales con un nebulizador para el flujo cromatográfico y otro para ionizar unos compuestos de referencia, permitiendo una calibración constante del equipo.

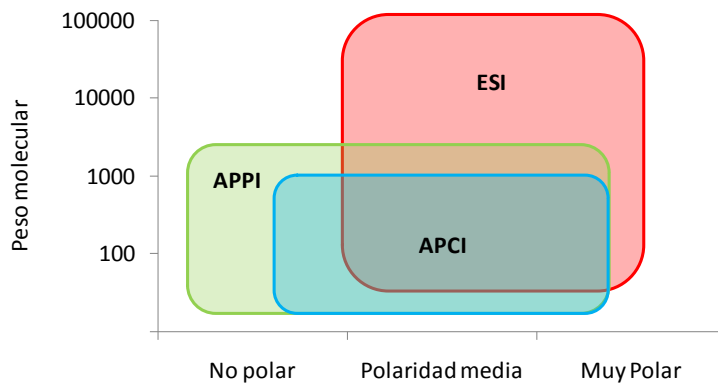



Figura III.13. Foto real de un electrospray (arriba izq.), una dual ESI (arriba derecha) y esquema de los procesos de ionización por ESI (abajo).

Ionización química a presión atmosférica (APCI). En este caso, la fase móvil y los analitos que provienen del HPLC son nebulizados en pequeñas gotas (sin carga, a diferencia de ESI) y evaporados rápidamente mediante una corriente de nitrógeno coaxial en una cámara a alta temperatura (300 – 550 °C), de tal modo que es el calor el que evapora la fase móvil y los analitos [130]. Se podría pensar que estas temperaturas de trabajo tan elevadas podrían degradar algunos analitos pero el flujo de nitrógeno coaxial y la alta velocidad de flujo que proviene del HPLC evitan dicho efecto.

La ionización se produce debido a un electrodo en forma de aguja que por efecto corona (aguja corona) genera un haz de electrones que ioniza los gases dentro de la cámara de ionización (gases atmosféricos y fase móvil en fase gaseosa) dando lugar a pequeño plasma como se observa en la Figura III.14. Este plasma es el que produce la ionización de los analitos que están en fase gaseosa; este mecanismo de ionización hace que sea fundamental una alta velocidad del flujo cromatográfico ( $\geq 1$  mL/min) para que este plasma sea estable.

Las reacciones que puedan tener lugar en el seno de esta fase gaseosa dependen de la propia naturaleza del plasma y los analitos; en modo positivo sobre todo, la afinidad protónica (similar a ESI); mientras que en modo negativo, cuyo uso es menos común, el mecanismo de ionización suele ocurrir por la pérdida de un protón (como en ESI) y/o captura de un electrón. Debido a que la formación de iones se produce en fase gas, al igual que GC, no es adecuada para compuestos no volátiles o térmicamente lábiles.

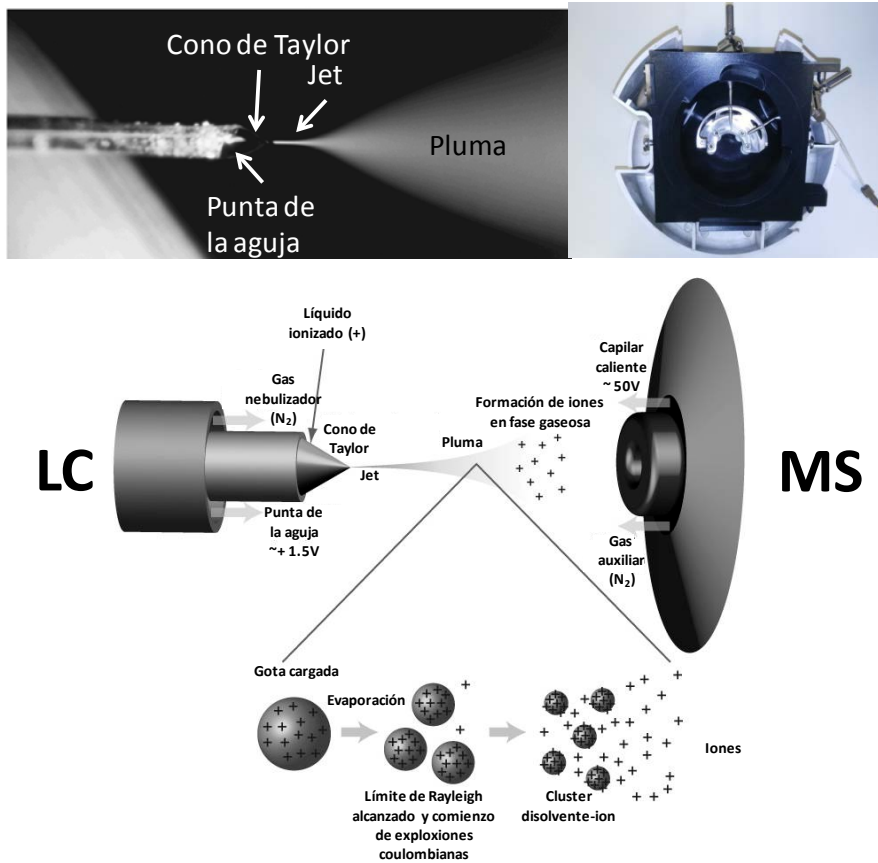

Figura III.14. Foto de una fuente APCI con el plasma formado (izquierda) y esquema del proceso de ionización (derecha).

La ionización por electrospray y la ionización química a presión atmosférica son técnicas de ionización complementarias (como se puede observar en la Figura III.12) y compatibles entre sí, ya que ambas usan una corriente de un gas caliente para la desolvatación de los analitos. Estas características llevaron a la combinación de las fuentes ESI y APCI en una sola fuente (véase Figura III.15) multimodo; esto permite poder desarrollar

aplicaciones para especies con un amplio rango de masa molecular. Se suele utilizar para métodos de *screening* que requieran detectar un rango amplio de compuestos sin necesidad de realizar dos análisis intercambiando las fuentes, reduciendo costes y tiempo de análisis.

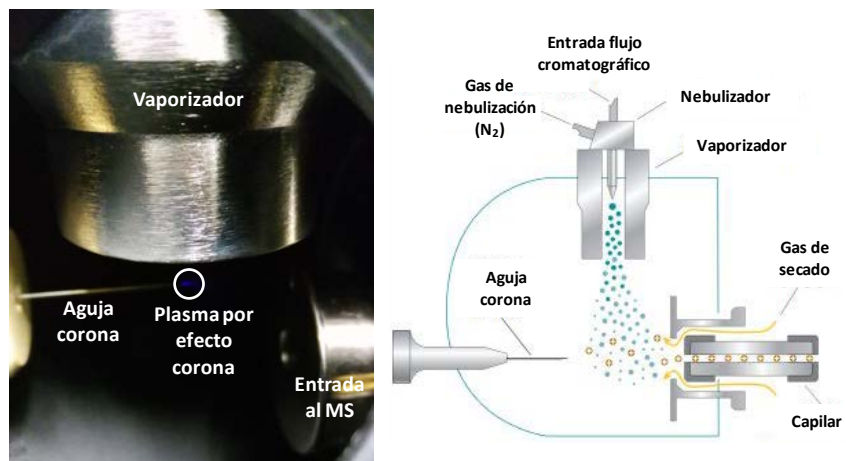

Figura III.15. Fotografía de una fuente multimodo ESI-APCI (izquierda) y esquema de la misma (derecha).

Fotoionización a presión atmosférica (APPI). Se podría hablar de la fotoionización a presión atmosférica (APPI) como una APCI que usa la absorción de energía radiante emitida por una fuente ultravioleta para iniciar la ionización. Este proceso de fotoionización se basa en que la energía radiante absorbida por los analitos es mayor que el potencial de ionización (PI) para la pérdida de un primer protón por parte de la molécula de analito [131] como se muestra en la Figura III.16. La APPI generalmente produce iones moleculares ( $M^+$ ) y escasa fragmentación. La ionización no depende de reacciones en fase gaseosa ni de la química ácido-base como ocurre en ESI o APCI, por tanto, la APPI puede utilizarse en aplicaciones para especies no ionizables o difícilmente ionizables mediante los procesos dados en ESI o APCI. La eficacia de este tipo de ionización en algunos casos se ve comprometida debido a la absorción de fotones por parte de los disolventes y otras especies.

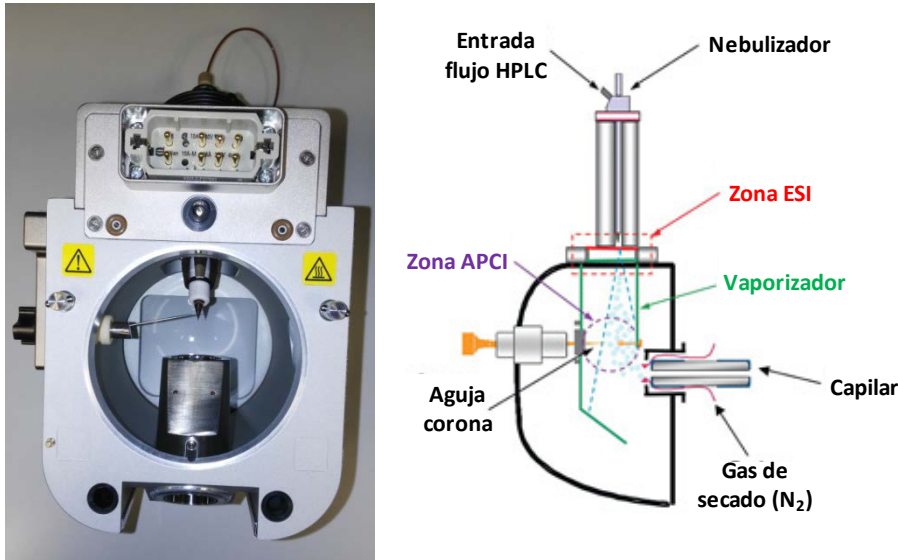

Figura III.16. Esquema de una fuente APPI y proceso de ionización.

### III.4.2.3. Papel Spray

La técnica de Papel Spray fue introducida por Cooks y colaboradores [132] en 2010, mostrando buenas cualidades para el desarrollo de análisis rápidos tanto desde el punto de vista cualitativo como cuantitativo en muestras complejas. Como se observa en la Figura III.17, la técnica se basa en la formación de un electrospray originado por la aplicación de un alto voltaje. El soporte de la muestra, consta de un material poroso (generalmente papel) con un acabado puntiagudo que se sitúa enfrente del espectrómetro de masas. La capilaridad del papel permite el transporte de los analitos a lo largo del mismo, mientras que la aplicación de un elevado potencial eléctrico da lugar a su ionización. La carga de la muestra puede realizarse empleando disoluciones que se depositan directamente sobre el papel, o bien, emplear el mismo papel como sustrato de muestreo de superficies sólidas.

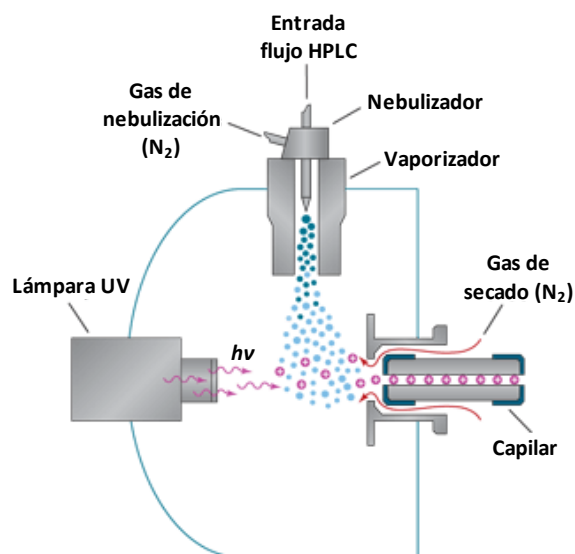

Figura III.16. Esquema del procedimiento de carga, elución y detección en la técnica del "Paper Spray".

#### III.4.2.4. Fuentes de ionización por descarga de barrera dieléctrica.

##### Fundamentos

La Descarga de Barrera Dieléctrica (DBD) es un método de generación de plasma frío (en contraste con la alta cinética de los electrones, que provoca un desequilibrio termodinámico), capaz de ionizar diferentes gases de trabajo, como helio, argón o aire, en un amplio rango de presiones. También recibe el nombre de plasma por descarga piezoeléctrica directa, y descarga fría. En inglés se le conoce como *Dielectric Barrier Discharge*.

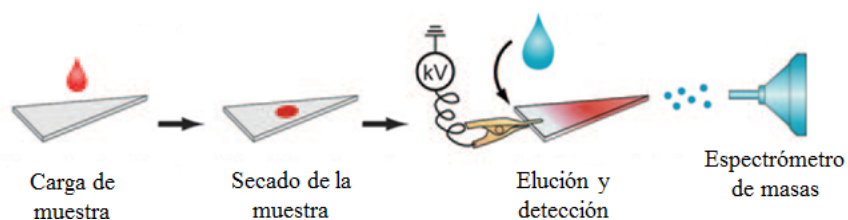
La DBD es capaz de producir electrones de alta energía que darán lugar a átomos excitados (metaestables) que originarán iones positivos y negativos. Algunos de los parámetros que afectan a una DBD son: la amplitud (voltaje), la frecuencia de la corriente alterna, la naturaleza del gas de descarga, la forma de la onda, el flujo del gas, naturaleza y grosor del dieléctrico, distancia entre los electrodos, etc.

En 1857, Werner (von) Siemens y colaboradores propusieron por primera vez un sistema para la producción de ozono basado en el uso de dos electrodos anulares separados por un dieléctrico [133] como se observa en la Figura III.18.

Está caracterizada por la presencia de una capa o barrera de material dieléctrico, que cubre por lo menos uno de los electrodos, que puede funcionar a presión atmosférica para muchas aplicaciones como generación de ozono, tratamiento de superficies, fuente de ionización, etc. Las barreras impiden que las cargas generadas en el gas toquen el electrodo evitando así un desgaste rápido del mismo.

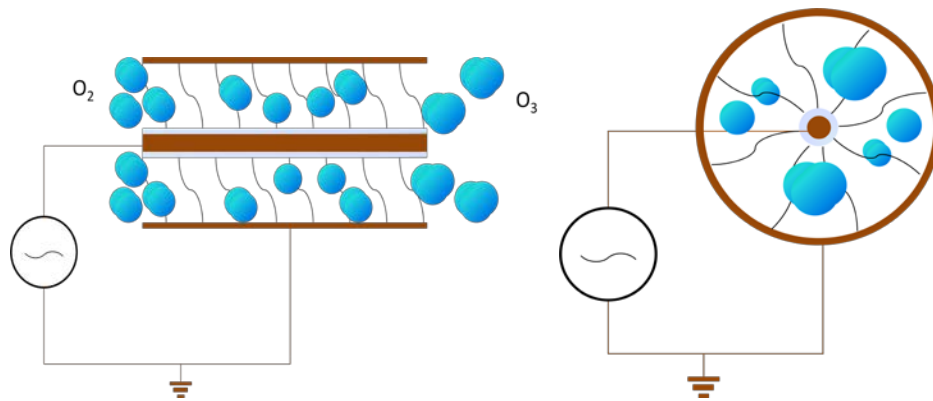

**Figura III.18.** Esquema del sistema de generación de ozono presentado por Werner (von) Siemens y colaboradores basado en el principio de DBD.

En este contexto, la ley de Paschen (Friedrich Paschen, 1889) [134] describe los límites del encendido del plasma en función de la presión y de la distancia entre electrodos:

$$V = \frac{a \cdot P \cdot d}{\ln(P \cdot d) + b}$$

siendo: V = Tensión disruptiva en voltios; P = Presión del gas en atmósferas; d = Distancia entre láminas en metros; a y b constantes que dependen del gas.

En 2008, el profesor R. G. Cooks y colaboradores desarrollaron un plasma de baja temperatura (LTP por sus siglas en inglés) generado por DBD [135] como se muestra en la Figura III.19.



Figura III.19. (izq) Esquema de una sonda LTP. (der) Fotografía de la fuente LTP [135].

De forma paralela, Franzke y colaboradores trabajaban en microchips para obtener plasmas en miniatura [136]. En 2007 desarrollaron un diseño nuevo en forma de sonda [137] pero más pequeña que la diseñada por el grupo de Cooks y que refinaron y estudiaron durante 2008 [138] y 2009 [139], y que denominaron DBDI. Una fotografía de esta sonda se muestra en la Figura III.20. La parte más externa del plasma que sobresale de la sonda se denomina *plasmajet*. Actualmente, Franzke y col., siguen desarrollando nuevos diseños de sonda y caracterizando el plasma generado por DBD [139–142].

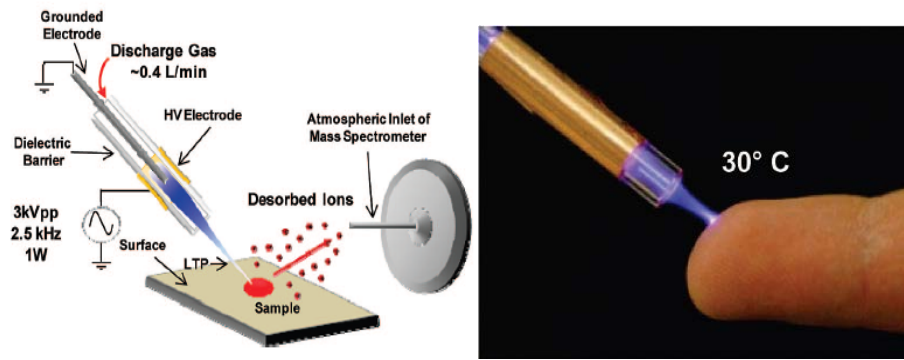

Figura III.20. Fotografía de la sonda DBDI y el *plasmajet* [136-139].

## Modos de operación

La DBD produce electrones de elevada energía provocando que, con un voltaje adecuado, los átomos del gas de descarga (generalmente helio) pasen a un estado electrónico excitado de elevada energía. Este proceso se resume a través de la expresión:

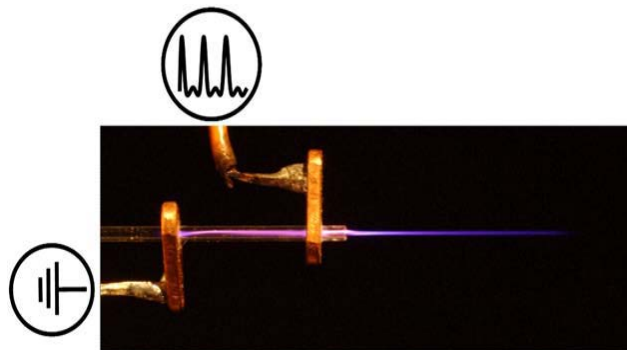
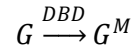

Estos átomos metaestables a su vez provocan una ionización tipo Penning, llamada así por el autor del primer estudio que la describía (F. M. Penning [143]) y que se trata en el siguiente apartado. El plasma puede trabajar en dos modos, homogéneo o filamentario [144,145]. La diferencia entre un modo u otro de trabajo, a un flujo de 500 ml/min de He, corresponde a un voltaje de unos 4 kV. Por encima de 4 kV, en el plasma las partículas en su estado fundamental poseen una distribución fuertemente no homogénea. Sin embargo, a pesar de su falta de homogeneidad, el plasma es axialmente simétrico al eje del capilar. Por debajo de 4 kV, se generan microdescargas que se distribuyen de forma homogénea a lo largo del capilar. A simple vista, el cambio de régimen se aprecia en el hecho de que al pasar de 3.8 kV a más de 4kV el plasma se vuelve más brillante y el *plasmajet* se hace más corto (Figura III.21 izquierda). Además, si monitorizamos el voltaje y la corriente, observamos que al pasar de 3.8 kV a más de 4 kV, aparecen picos de corriente adicionales distribuidos de forma aleatoria (Figura III.20 Derecha).

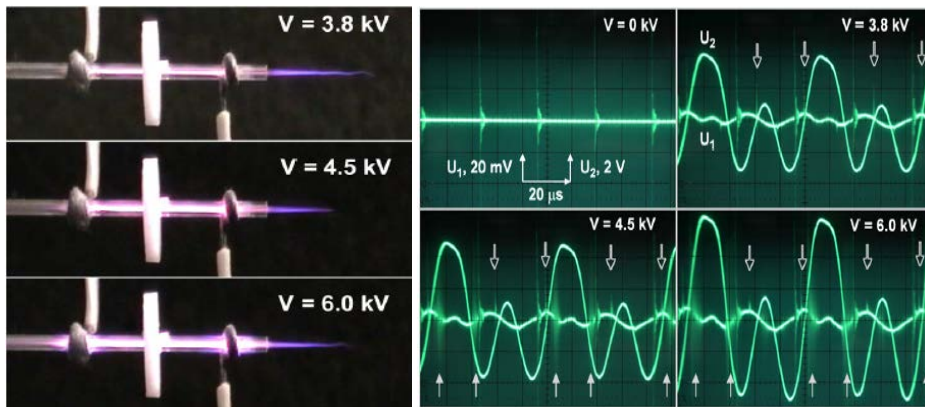

**Figura III.21.** [izquierda] Fotografías donde se observa claramente la diferencia entre el plasma y el *plasmajet* en el régimen homogéneo (3.8 kV) y el filamentario (4.5 y 6.0 kV). [derecha] Monitorización de la corriente ( $U_1$ ) y el voltaje ( $U_2$ ) [145].



Desde el punto de vista de su aplicación al análisis químico, se observan mejores señales usando el modo homogéneo, debido a que hay más especies  $N_2^+$  en el *plasmajet*. En el modo filamentario, un menor número de átomos de He son excitados al estado metaestable ( $He^M$ ) y, por consiguiente, menor número de  $N_2^+$ , lo que implica que hay una menor cantidad de especies ionizantes, disminuyendo drásticamente la señal del analito o los analitos de interés.

### Ionización tipo Penning

Es una ionización química a presión atmosférica consistente en que un gas noble en un estado excitado metaestable (en este caso por DBD) interacciona con una molécula neutra, ionizándola al arrancarle un electrón como se observa a continuación. En el caso de la fuente DBD desarrollada por Franzke y col., las reacciones que se producen se incluyen a continuación junto con el diagrama de energía (Figura III.22) con los estados electrónicos de los gases implicados [137–139]:

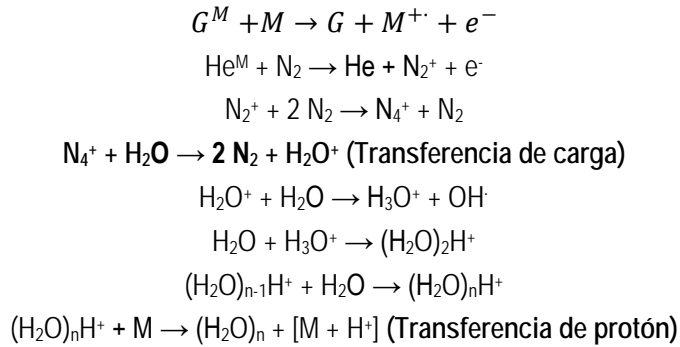



Figura III.22. Diagrama de energía de los estados electrónicos de nitrógeno molecular, helio, neón, argón y el nivel de energía de ionización del agua.

Recientes estudios sobre los mecanismos de ionización de distintas fuentes basadas en el uso de un plasma, han revelado la posibilidad de que la formación de iones, no solo se dé mediante transferencia de protones a través de *clusters* de moléculas de agua, también a partir de cationes radicales [146].

### III.5. Antecedentes

#### III.5.1. Compuestos fenólicos

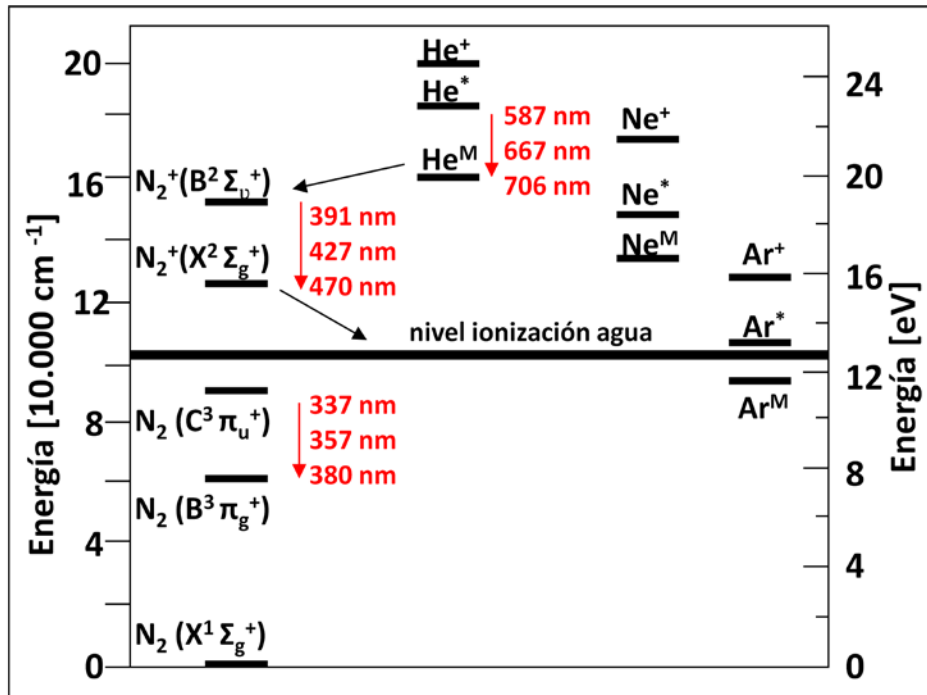
El análisis de compuestos fenólicos, debido a su capacidad antioxidante, ha despertado un gran interés en los últimos años. El método de Folin-Ciocalteu (FC) es el método más utilizado para la cuantificación del contenido total en compuestos fenólicos en muestras de alimentos [147]. Este método se basa en la reacción redox que se produce entre el reactivo de Folin-Ciocalteu y los compuestos fenólicos a pH básico. El reactivo de Folin-Ciocalteu es el ácido fosfomolibdotúngstico, una mezcla de wolframato sódico y

molibdato sódico en ácido fosfórico de color amarillo. Cuando este ácido es reducido por los compuestos fenólicos se produce un compuesto de color azul intenso, susceptible de ser determinado mediante espectrofotometría UV-Vis a 765 nm, donde presenta un máximo de absorción.

La cuantificación del contenido total en compuestos fenólicos en aceite de oliva mediante el método de FC se realiza usando una recta de calibrado utilizando ácido cafeico como patrón. Los compuestos fenólicos son extraídos previamente mediante una extracción líquido-líquido con una mezcla metanol:agua, aprovechando la naturaleza particularmente polar de estos compuestos en una matriz tan apolar como es el aceite de oliva [148]. Este método es lento, puesto que requiere de 1 a 2 horas de incubación, e inespecífico, ya que se mide la capacidad reductora del aceite de oliva que no es solo ejercida por los compuestos fenólicos, sino también por otros compuestos antioxidantes como los tocoferoles, si bien su contribución suele ser irrelevante frente a la de los compuestos fenólicos. Como se detalla en la tabla III.9, para suplir estas carencias se han propuesto métodos alternativos, algunos de ellos basados en la automatización. Estos métodos aumentan en gran medida la capacidad de análisis por hora.

Por otro lado, los métodos cromatográficos aunque capaces de determinar los distintos compuestos fenólicos, consumen demasiado tiempo para los análisis de rutina donde suele interesar la cantidad total. Así, el método oficial para la determinación de compuestos fenólicos en aceite se basa en un análisis mediante HPLC-UV de 85 min de duración, para finalmente expresar el contenido total en biofenoles como mg/kg de tiro-sol [66]. En este sentido, se ha avanzado en el desarrollo de métodos cromatográficos más rápidos gracias al uso de columnas con menor tamaño de partícula, y más específicos gracias al uso de espectrómetros de masas como sistema de detección (ver Tabla III.9)

**Tabla III.9.** Metodologías para la determinación de compuestos fenólicos en aceite de oliva.

Técnica/s usada/s	Método	Referencia/s
Espectroscopía Ultravioleta-Visible.	Medida de la absorbancia de los productos de reacción de los compuestos fenólicos extraídos del aceite de oliva con el reactivo de Folin-Ciocalteu.	[142]
HPLC <b>Método de referencia</b>	Extracción líquido-líquido de los biofenoles y posterior análisis mediante HPLC-UV (280 nm)	[66]
HPLC	Método HPLC con detector de captura electrónica usando una extracción en fase sólida SPE previa.	[149]
Fotometría	Medida de la absorbancia de la emulsión formada a partir del aceite de oliva y el reactivo de Folin-Ciocalteu a 835 nm, usando un LED y un fotodiodo.	[150]
Optosensor	Automatización mediante un sistema de inyección en flujo (FIA) del método de Folin-Ciocalteu con extracción líquido-líquido de los compuestos fenólicos del aceite de oliva integrada en el sistema.	[104]
Robotización	Robotización del método de Folin-Ciocalteu en el que se integra automuestreador, una extracción líquido-líquido y medida por espectrofotometría ultravioleta-visible (UV-Vis).	[103]
HPLC	Extracción SPE y medida por HPLC-TOFMS	[151]

### III.5.2. Peróxidos

El índice de peróxidos de los aceites de oliva se determina de forma oficial mediante una técnica clásica como es una volumetría redox. Se han propuesto métodos alternativos espectroscópicos basados en absorción UV-VIS, mediante el empleo de la espectroscopía infrarroja o recurriendo a la emisión de luz por quimioluminiscencia; siendo esta última realmente selectiva. En la Tabla III.10 se muestran algunos ejemplos de métodos desarrollados para la medida del índice de peróxidos en aceite de oliva.

Tabla III.10. Metodologías para la determinación del índice de peróxidos en aceite de oliva.

Técnica/s usada/s	Método	Referencia/s
Valoración. <b>Método oficial</b>	Volumetría rédox en la que se valora con tiosulfato sódico el yodo liberado por reacción de los peróxidos con yoduro potásico.	[46, 152, 153]
Quimioluminiscencia	Emisión de luz debido a la quimioluminiscencia natural que ocurre al reaccionar los peróxidos con un compuesto que genere dicha quimioluminiscencia en medio básico usando un catión metálico de transición como catalizador.	[150, 154]
Fotometría	Incremento de la absorbancia de una emulsión de aceite debido a la oxidación de Fe (II) a Fe (III) producida por los peróxidos.	[155]
Inyección en flujo (FIA)	Sistema FIA detectando por espectroscopía UV-Vis el yodo liberado por la reacción del NaI con los peróxidos del aceite.	[102, 106]
Espectroscopía en el Infrarrojo Cercano (NIR)	Espectroscopía NIR combinada con quimiometría.	[156]
Espectroscopía Infrarroja aplicando Transformada de Fourier (FT-MIR)	Predicción del índice de peróxidos mediante FT-MIR combinado con quimiometría.	[157]

### III.5.3. Tocoferoles

El método oficial en este caso es la cromatografía líquida en fase normal con detección por fluorescencia. Otros métodos alternativos pueden observarse en la Tabla III.11.

Tabla III.11. Metodologías para la determinación de tocoferoles en aceite de oliva

Técnica/s usada/s	Método	Referencia/s
Cromatografía de líquidos. <b>Método oficial</b>	Cromatografía líquida en fase normal	[67]
Cromatografía de líquidos (HPLC)	Cromatografía líquida en fase normal y reversa mediante detección por fluorescencia	[82, 158–161]
Cromatografía de líquidos acoplada a espectrometría de masas (HPLC-MS)	Cromatografía líquida en fase reversa acoplada a espectrometría de masas	[85, 162]
Fluorescencia	Determinación de tocoferoles mediante la fluorescencia nativa de los mismos	[163]

En este caso la cromatografía resulta lenta para análisis de rutina y, en el caso de usar espectrometría de masas, algo más compleja y costosa. Teniendo en cuenta que el tocoferol mayoritario es el  $\alpha$ -tocoferol en el aceite de oliva, no es totalmente necesaria la separación cromatográfica si se desea una estimación del contenido total de tocoferoles, como se muestra más adelante en esta tesis.

#### III.5.4. Análisis directo de aceite por espectrometría de masas

El perfilado de aceites mediante técnicas analíticas avanzadas en la mayoría de los casos utiliza el acoplamiento GC-MS o LC-MS. No obstante, la espectrometría de masas es una herramienta analítica tan potente, que no necesariamente debe estar acoplada a una técnica separativa para obtener resultados de calidad. De este modo podemos realizar análisis directos ahorrándonos realizar un pretratamiento de muestra y ahorrando el tiempo que demora la realización de la separación cromatográfica. Para este fin se pueden usar tanto las fuentes que normalmente actúan como interfases en el acoplamiento de técnicas separativas (ESI, APCI y APPI) [164–168] y espectrometría de masas como otras que están diseñadas para realizar la desorción de la muestra sobre una superficie [169], como la fuente para el análisis directo en tiempo real [170], mediante un plasma de baja temperatura [171] o mediante un simple triángulo de papel al que se le aplica una diferencia de potencial [172]. En la Tabla III.12 aparecen resumidas algunas aplicaciones con distintas fuentes de ionización para el análisis directo de aceite de oliva mediante espectrometría de masas.

**Tabla III.12.** Tipos de fuentes de ionización para análisis directo de aceite de oliva mediante espectrometría de masas.

Analitos	Fuente de ionización	Símbolo	Referencias
Iones diagnóstico como Oleato y Palmitato	Electrospray	ESI	[164,165,168]
Perfil de triglicéridos	Electrospray	ESI	[166]
Perfil de triglicéridos	Fotoionización a presión atmosférica	APPI	[166]
Compuestos fenólicos, tocoferoles y ácidos grasos y sus respectivas especies oxidadas	Ionización química a presión atmosférica	APCI	[167]
Perfil de triglicéridos y sus fragmentos	Análisis directo en tiempo real	DART	[170]
Ácidos grasos libres y compuestos fenólicos	Plasma de baja temperatura	LTP	[171]
Compuestos fenólicos	Papel Spray	PS	[172]

### III.5.5. Métodos utilizados para la determinación de residuos de plaguicidas

El análisis de residuos de plaguicidas en alimentos se suele realizar mediante la determinación simultánea de varias especies (métodos multiresiduo), por lo que se suelen utilizar técnicas cromatográficas, en ocasiones acopladas a espectrometría de masas. En las últimas décadas, los plaguicidas que se emplean suelen presentar grupos polares en su estructura, puesto que ello favorece su degradación y evita su acumulación en el medio ambiente. Por lo tanto, se ha propiciado el desarrollo de métodos HPLC para la determinación de plaguicidas polares, en detrimento de los métodos basados en la GC [173]. Además, en los últimos años, se ha incrementado el uso de detección por espectrometría de masas, más sensible y selectiva que los detectores ópticos tradicionales.

La primera dificultad a la hora de desarrollar estos métodos es la elección del método de extracción de los plaguicidas de una matriz grasa como es el aceite de oliva, que suele presentar muchos problemas de coextracciones cuando se utilizan disolventes orgánicos para obtener extractos de ciertos analitos de baja polaridad. Los métodos multiresiduo tienen la dificultad añadida de requerir la extracción simultánea de compuestos en un amplio rango de polaridad, para lo que usualmente se usan la extracción líquido-líquido (LLE por sus siglas en inglés) y la extracción en fase sólida (SPE por sus siglas en inglés). Las técnicas basadas en la SPE suelen obtener buenas recuperacio-

nes de analitos, así como extractos muy limpios. Se pueden encontrar en la bibliografía trabajos de revisión muy completos sobre los métodos de extracción de residuos de plaguicidas en matrices grasas como el aceite de oliva [174]. El método QuEChERS (siglas de *Quick, Easy, Cheap, Rugged, Safe*) es uno de los métodos más usados actualmente para la extracción de plaguicidas en alimentos por su sencillez, rapidez y facilidad de uso; en un reciente estudio ha resultado particularmente efectivo el uso del sorbente denominado *EMR-lipid* en la etapa de purificación para obtener extractos limpios de residuos de plaguicidas de aceite de oliva con buenas recuperaciones [175].

La segunda etapa crítica en el desarrollo de métodos multiresiduo basados en HPLC-MS es la ionización simultánea de compuestos de un amplio rango de polaridad a una sensibilidad suficiente para alcanzar límites de detección por debajo de las concentraciones máximas de plaguicidas admitidas por la legislación. Las fuentes de ionización más utilizadas son ESI y APCI que, como se ha comentado anteriormente, son complementarias y no ionizan bien el mismo tipo de compuestos. Es por ello que en la presente tesis doctoral se abarcará el estudio de la fuente DBDI (ver apartado III.4.2.3.) como alternativa para la ionización, en un solo análisis, de residuos de plaguicidas comprendidos en un rango de polaridad mayor que el que pueden cubrir ESI y APCI. Hasta la fecha, la mayoría de los métodos HPLC-MS aplicados al análisis multiresiduo de plaguicidas en aceite de oliva, utilizan ESI como fuente de ionización [174–178].



### III. 6. Referencias

- [1] J.M. Blázquez, Origen y difusión del cultivo, *Encicl. Mund. Del Olivo*. (1996) 19–25.
- [2] Real Academia Española, *Diccionario de la Real Academia Española*, Espasa, Madrid (España), 2014.
- [3] J. Remesal Rodríguez, *Economía oleícola: En la Edad Moderna*, *Encicl. Mund. Del Olivo*. (1996) 53.
- [4] Consejería de Agricultura, Pesca y Desarrollo Rural. Junta de Andalucía, (2016).
- [5] Ministerio de Agricultura, Alimentación y Medio Ambiente. Gobierno de España, (2013).
- [6] International Olive Council, *European Union Olive Oil Production*, Int. Olive Council. Webpage. (2016).
- [7] M. de Agricultura, Alimentación y Medioambiente, *Evolución de la superficie del olivar en España*, (2013).
- [8] M. de Agricultura, Alimentación y Medioambiente, *Encuesta sobre Superficies y Rendimientos de Cultivos*, (2015).
- [9] M. de Agricultura, Alimentación y Medioambiente, *Superficies y producciones de cultivos Marzo 2015*, (2015).
- [10] European Commission, *European Commission, Agriculture and Rural Development, Olive oil*. [https://ec.europa.eu/agriculture/olive-oil/prices\\_en](https://ec.europa.eu/agriculture/olive-oil/prices_en).
- [11] D. Boskou, G. Blekas, M. Tsimidou, *Olive Oil Composition*, in: D. Boskou (Ed.), *Olive Oil Chem. Technol.*, Second, Aristotle University of Thessaloniki, Thessaloniki, 2006: pp. 41–63.
- [12] A. Keys, *Coronary heart disease in seven countries. Summary*, *Circulation*. XLI (1970) 186–195.
- [13] A. Keys, *Coronary heart disease in seven countries. XVII. The Diet*, *Circulation*. XLI (1970) 162–183.
- [14] M.N. Vissers, P.L. Zock, S.A. Wiseman, S. Meyboom, M.B. Katan, *Effect of phenol-rich extra virgin olive oil on markers of oxidation in healthy volunteers*, *Eur. J. Clin. Nutr.* 55 (2001) 334–341.
- [15] S. Cicerale, X.A. Conlan, A.J. Sinclair, R.S.J. Keast, *Chemistry and Health of Olive Oil Phenolics*, *Crit. Rev. Food Sci. Nutr.* 49 (2009) 218–236.
- [16] M.I. Castañer, O., Fitó, M., López-Sabater, M. C., Poulsen, H. E., Nyssönen, K., Schröder, H., Salonen, J. T., De la Torre-Carbot, K., Zunft, H. F., De la Torre, R., Bäumer, H., Gaddi, A., V., Saez, G. T., Tomás, M., Covas, *The effect of olive oil polyphenols on antibodies against oxidized LDL. A randomized clinical trial.*, *Clin. Nutr.* 30 (2011) 490–493.
- [17] M. León-Camacho, M.T. Morales, R. Aparicio-Ruíz, *Chromatographic Methodologies: Compounds for Olive Oil Traceability Issues*, in: R. Aparicio, J. Harwood (Eds.), *Olive Oil Handb.*, Second, New York, 2013.
- [18] F. Santinelli, P. Damiani, W.W. Christie, *The Triacylglycerol Structure of Olive*

- Oil Determined by Silver Ion High-Performance Liquid Chromatography in Combination with Stereospecific Analysis, *J. Am. Oil Chem. Soc.* 69 (1992) 552–556.
- [19] G. Vlahov, <sup>13</sup>C nuclear magnetic resonance spectroscopy to check 1, 3-random, 2-random pattern of fatty acid distribution in olive oil triacylglycerols, *Spectroscopy*. 19 (2005) 109–117.
- [20] A. Lozano-Sánchez, J., Segura-Carretero, A., Fernández-Gutiérrez, Composición del aceite de oliva., in: A. Fernández-Gutiérrez, Alberto, Segura-Carretero (Ed.), *El Aceite Oliva Virgen Tesoro Andalucía.*, Servicio de Publicaciones de la Fundación Unicaja, Málaga (España), 2009.
- [21] D. Grigoriadou, A. Androulaki, E. Psomiadou, M. Tsimidou, Food Chemistry Solid phase extraction in the analysis of squalene and tocopherols in olive oil, *Food Chem.* 105 (2007) 675–680.
- [22] Á. Fernández-Cuesta, L. León, L. Velasco, R. De la Rosa, Changes in squalene and sterols associated with olive maturation, *Food Res. Int.* 54 (2013) 1885–1889.
- [23] L. Gallardo-Guerrero, B. Gandul-Rojas, M. Roca, M.I. Mínguez-Mosquera, Effect of storage on the original pigment profile of Spanish virgin olive oil, *JAOCs, J. Am. Oil Chem. Soc.* 82 (2005) 33–39.
- [24] M.T. Morales, R. Aparicio-Ruiz, R. Aparicio, Chromatographic Methodologies: Compound for Olive Oil Odor Issues, in: R. Aparicio, J. Harwood (Eds.), *Olive Oil Handbook, Second*, New York, 2013: pp. 261–304.
- [25] F. Caponio, T. Gomes, Influence of olive crushing temperature on phenols in olive oils, *Eur. Food Res. Technol.* 212 (2001) 156–159.
- [26] S.M. Preziuso, G.M. Di Serio, A. Biasone, R. Vito, M.R. Mucciarella, L. Di Giovacchino, Influence of olive crushing methods on the yields and oil characteristics, *Eur. Food Res. Technol.* 112 (2010) 1345–1355..
- [27] A. Tamendjari, F. Angerosa, S. Mettouchi, M.M. Bellal, The effect of fly attack (*Bactrocera oleae*) on the quality and phenolic content of Chemlal olive oil, *Grasas Y Aceites.* 60 (2009) 507–513.
- [28] C. Di Vaio, S. Nocerino, A. Paduano, R. Sacchi, Influence of some environmental factors on drupe maturation and olive oil composition, *J. Sci. Food Agric.* 93 (2013) 1134–1139.
- [29] M. Tsimidou, Analytical Methodologies: Phenolic Compounds Related to Olive Oil Taste Issues, in: R. Aparicio, J. Harwood (Eds.), *Olive Oil Handb., Second*, New York, 2013: pp. 311–335.
- [30] D. Boskou, M. Tsimidou, G. Blekas, Polar Phenolic Compounds, in: D. Boskou (Ed.), *Olive Oil Chemistry and Technology, Second Edition*, Aristotle University of Thessaloniki, Thessaloniki, 2006: pp. 73–92.
- [31] M. Brenes, A. García, P. García, J.J. Ríos, A. Garrido, Phenolic Compounds in Spanish Olive Oils, *J. Agric. Food Chem.* 47 (1999) 3535–3540.
- [32] V. Fogliano, R. Sacchi, Oleocanthal in olive oil: Between myth and reality, *Mol. Nutr. Food Res.* 50 (2006) 5–6.

- [33] M. Brenes, F.J. Hidalgo, A. García, J.J. Ríos, P. García, R. Zamora, A. Garrido, Pinoresinol and 1-Acetoxypinoresinol, Two New Phenolic Compounds Identified in Olive Oil, *J. Am. Oil Chem. Soc.* 77 (2000) 715–720.
- [34] R.W. Owen, W. Mier, A. Giacosa, W.E. Hull, B. Spiegelhalter, H. Bartsch, Identification of Lignans as Major Components in the Phenolic Fraction of Olive Oil, *Clin. Chem.* 46 (2000) 976–988.
- [35] E. Perri, A. Raffaelli, G. Sindona, Quantitation of Oleuropein in Virgin Olive Oil by Ion Spray Mass Spectrometry - Selected Reaction Monitoring, *J. Agric. Food Chem.* 47 (1999) 4156–4160.
- [36] S. Christophoridou, P. Dais, Detection and quantification of phenolic compounds in olive oil by high resolution  $^1\text{H}$  nuclear magnetic resonance spectroscopy, *Anal. Chim. Acta.* 633 (2009) 283–292.
- [37] R. Mateos, J.L. Espartero, M. Trujillo, J.J. Ríos, M. León-Camacho, F. Alcudia, A. Cert, Determination of Phenols, Flavones, and Lignans in Virgin Olive Oils by Solid-Phase Extraction and High-Performance Liquid Chromatography with Diode Array Ultraviolet Detection, *J. Agric. Food Chem.* 49 (2001) 2185–2192.
- [38] International Olive Council, COI/T.15/NC No 3/Rev. 11. Trade standard applying to olive oils and olive-pomace oils, *Int. Olive Council. Webpage.* (2016).
- [39] Codex Alimentarius Council, Standard for olive oils and olive pomace CODEX STAN 33-1981, (2017).
- [40] E. Commission, COMMISSION REGULATION (EEC) No 2568/91 of 11 July 1991. On characteristics of olive oil and olive-residue oil and on the relevant methods of analysis, *Off. J. Eur. Union.* (1991).
- [41] International Olive Council, COI/T.20/Doc. No 15/Rev. 8. Sensory Analysis of Olive Oil. Method for the Organoleptic Assessment of Virgin Olive Oil, *Int. Olive Council. Webpage.* (2015).
- [42] International Olive Council, COI/T.20/Doc. No 4/Rev. 1. Sensory Analysis: general basic vocabulary, *Int. Olive Council. Webpage.* (2007).
- [43] International Olive Council, COI Decision No DEC-14/103-V/2015. Revising the Method for the Organoleptic Assessment of Virgin Olive Oil, *Int. Olive Council. Webpage.* (2013).
- [44] International Olive Council, COI/T.20/Doc. No 34. Determination of free fatty acids, cold method, *Int. Olive Council. Webpage.* (2015).
- [45] AENOR, Aceites y grasas de origen animal y vegetal. Determinación del índice de acidez y de la acidez (ISO 660:2009), (2009).
- [46] International Olive Council, COI/T.20/Doc. No 35. Determination of peroxide value, *Int. Olive Council. Webpage.* (2016).
- [47] International Olive Council, COI/T.20/Doc. No 19/Rev. 3. Spectrophotometric investigation in the ultraviolet, *Int. Olive Council. Webpage.* (2015).
- [48] International Organization for Standardization (ISO), ISO 3656:2011. Animal and vegetable fats and oils - Determination of ultraviolet absorbance expressed as specific UV extinction, (2011).
- [49] AOCS, AOCS Official Method Ch 5-91. Specific Extinction of Oils and Fats,

- Ultraviolet Absorption, Off. Methods Recomm. Pract. AOCS. (2017).
- [50] AENOR, Aceites y grasas de origen animal y vegetal. Cromatografía de gases de ésteres metílicos de ácidos grasos. Parte 1: Directrices sobre cromatografía de gases moderna de los ésteres metílicos de ácidos grasos (ISO 12966-1:2014), (2016).
- [51] AENOR, Aceites y grasas de origen animal y vegetal. Cromatografía de gases de ésteres metílicos de ácidos grasos. Parte 2: Preparación de ésteres metílicos de ácidos grasos (ISO 12966-2:2011), (2009).
- [52] AENOR, Aceites y grasas de origen animal y vegetal. Cromatografía de gases de ésteres metílicos de ácidos grasos. Parte 3: Preparación de ésteres de metilo utilizando hidróxido de trimetilsulfonio (TMSH) (ISO 12966-3:2016), (2016).
- [53] AENOR, Aceites y grasas de origen animal y vegetal. Cromatografía de gases de ésteres metílicos de ácidos grasos. Parte 4: Determinación por cromatografía capilar en fase gaseosa (ISO 12966-4:2015), (2015).
- [54] International Olive Council, COI/T.20/Doc. No 33. Determination of fatty acid methyl esters by gas-chromatography, Int. Olive Council. Webpage. (2015).
- [55] International Olive Council, COI/T.20/Doc. No 30/Rev. 1. Determination of the composition and content of sterols and triterpene dialcohols by capillary column gas chromatography, Int. Olive Council. Webpage. (2013).
- [56] AENOR, Determinación de los contenidos individuales y totales de esteroides. Método por cromatografía de gases Parte 1: Aceites y grasas de origen animal y vegetal (ISO 12228-1:2014), (2015).
- [57] International Olive Council, COI/T.20/Doc. No 11. Determination of stigmastadienes in vegetable oils, Int. Olive Council. Webpage. (2001).
- [58] AENOR, Aceites y grasas de origen animal y vegetal. Determinación de estigmastadienos en aceites vegetales. Parte 1: Método mediante cromatografía gaseosa en columnas capilares (Método de referencia) (ISO 15788-1:1999), (2006).
- [59] AENOR, Aceites y grasas de origen animal y vegetal. Determinación de estigmastadienos en aceites vegetales. Parte 2: Método mediante cromatografía líquida de alta resolución (HPLC) (ISO 15788-2:2003), (2005).
- [60] AOCS, AOCS Official Method Cd 26-96. Stigmastadienes in Vegetable Oils, Off. Methods Recomm. Pract. AOCS. (2017).
- [61] International Olive Council, COI/T.20/Doc. no.18/ Rev. 2. Determination of Wax Content By Capillary Column, Int. Olive Council. Webpage. (2003).
- [62] International Olive Council, COI/T.20/Doc. No 20/ Rev. 3. Determination of the difference between actual and theoretical content of triacylglycerols with ECN 42, Int. Olive Council. Webpage. (2010).
- [63] AOCS, AOCS Official Method Ce 5b-89. Triglycerides in Vegetable Oils by HPLC, Off. Methods Recomm. Pract. AOCS. (2017).
- [64] International Olive Council, COI/T.20/Doc. No 23. Determination of the percentage of 2-glyceryl monopalmitate, Int. Olive Council. Webpage. (2006).

- [65] International Organization for Standardization (ISO), ISO 12872:2010. Olive oils and olive-pomace oils - Determination of the 2-glycerol monopalmitate content, (2010).
- [66] International Olive Council, COI/T.20/Doc. No 29. Determinación de los biofenoles de los aceites de oliva mediante HPLC, Int. Olive Council. Webpage. (2009).
- [67] AENOR, Aceites y grasas de origen animal y vegetal. Determinación de los contenidos de tocoferol y tocotrienol mediante cromatografía líquida de alta resolución (ISO 9936:2016), (2016).
- [68] F. Angerosa, C. Campestre, Sensory Quality: Methodologies and Applications, in: R. Aparicio, J. Harwood (Eds.), Olive Oil Handbook, Second Edition, New York, 2013: pp. 524–556.
- [69] International Olive Council, COI/T.20/Doc. No 14/Rev. 4. Sensory Analysis of Olive Oil standard guide for the selection, training and monitoring of skilled virgin olive oil tasters, Int. Olive Council. Webpage. (2013).
- [70] International Olive Council, COI/T.20/Doc. No 6/Rev. 1. Sensory Analysis of Olive Oil Standard Guide for the Installation of a Test Room, Int. Olive Council. Webpage. (2007).
- [71] International Olive Council, COI/T.20/Doc. No 5/Rev. 1. Sensory Analysis of Olive Oil. Standard. Glass for oil tasting, Int. Olive Council. Webpage. (2007).
- [72] A. Tur'yan, Y.I., Berezin, O.Y., Kuselman, I., Shenhar, pH-metric determination of acid values in vegetable oils without titration, J. Am. Oil Chem. Soc. 73 (1996) 295–301.
- [73] B. Grossi, M., Di Lecce, G., Toschi, T.G., Riccò, Fast and accurate determination of olive oil acidity by electrochemical impedance spectroscopy, IEEE Sens. J. 14 (2014) 2947-2954.
- [74] S. Baldo, M.A., Oliveri, P., Simonetti, R., Daniele, A novel electroanalytical approach based on the use of a room temperature ionic liquid for the determination of olive oil acidity, Talanta. 161 (2016) 881-887.
- [75] A. El-Abassy, R.M., Donfack, P., Materny, Rapid Determination of Free Fatty Acid in Extra Virgin Olive Oil by Raman Spectroscopy and Multivariate Analysis, J. Am. Oil Chem. Soc. 86 (2009) 507–511.
- [76] J.F. García Martín, Optical path length and wavelength selection using Vis/NIR spectroscopy for olive oil's free acidity determination, Int. J. Food Sci. Technol. 50 (2015) 1461–1467.
- [77] R.P.W. Scott, J.A. Perry, Introduction to Analytical Gas Chromatography, Marcel Dekker, New York, 1998.
- [78] International Olive Council, COI/T.20/Doc. No 28/Rev1. Determination of the content of waxes, fatty acid methyl esters and fatty acid ethyl esters by capillary gas chromatography, Int. Olive Council. Webpage. (2010).
- [79] N. Merchak, V. Silvestre, D. Loquet, T. Rizk, S. Akoka, J. Bejjani, A strategy for simultaneous determination of fatty acid composition, fatty acid position, and position-specific isotope contents in triacylglycerol matrices by <sup>13</sup>C-NMR, Anal.

- Bioanal. Chem. (2016) 1–19.
- [80] M.I. Sánchez-Rodríguez, E.M. Sánchez-López, A. Marinas, J.M. Caridad, F.J. Urbano, J.M. Marinas, Improving the estimations of fatty acids in several Andalusian PDO olive oils from NMR spectral data, *J. Appl. Stat.* 43 (2016) 1765–1793.
- [81] R. Aparicio-Ruiz, M.T. Morales, V. Alonso, Authentication of European Virgin Olive Oils by Their Chemical Compounds, Sensory Attributes, and Consumers' Attitudes, *J. Agric. Food Chem.* 45 (1997) 1076.1083.
- [82] J. Parcerisa, I. Casals, J. Boatella, R. Codony, M. Rafecas, Analysis of olive and hazelnut oil mixtures by high-performance liquid chromatography-atmospheric pressure chemical ionisation mass spectrometry of triacylglycerols and gas-liquid chromatography of non-saponifiable compounds (tocopherols and sterols), *J. Chromatogr. A.* 881 (2000) 149–158.
- [83] B. Cañabate-Díaz, A. Segura Carretero, A. Fernández-Gutiérrez, A. Belmonte Vega, A. Garrido Frenich, J.L. Martínez Vidal, J. Duran Martos, Separation and determination of sterols in olive oil by HPLC-MS, *Food Chem.* 102 (2007) 593–598.
- [84] J.L. Martínez-Vidal, A. Garrido-Frenich, M.A. Escobar-García, R. Romero-González, LC–MS Determination of Sterols in Olive Oil, *Chromatographia.* 65 (2007) 695–699.
- [85] W. Zarrouk, A. Carrasco-Pancorbo, M. Zarrouk, A. Segura-Carretero, A. Fernández-Gutiérrez, Multi-component analysis (sterols, tocopherols and triterpenic dialcohols) of the unsaponifiable fraction of vegetable oils by liquid chromatography-atmospheric pressure chemical ionization-ion trap mass spectrometry, *Talanta.* 80 (2009) 924–934.
- [86] B. Mathison, D. Holstege, A rapid method to determine sterol, erythrodiol, and uvaol concentrations in olive oil, *J. Agric. Food Chem.* 61 (2013) 4506–4513.
- [87] Q. Gu, X. Yi, J. Shen, J. Shi, Y. Liu, J. Shao, A highly automated method for simultaneous determination of sterols, erythrodiol and uvaol in olive oils, *Anal. Methods.* 8 (2016) 4022–4027.
- [88] Á. Aragón, J.M. Cortés, R.M. Toledano, J. Villén, A. Vázquez, Analysis of wax esters in edible oils by automated on-line coupling liquid chromatography-gas chromatography using the through oven transfer adsorption desorption (TOTAD) interface, *J. Chromatogr. A.* 1218 (2011) 4960–4965.
- [89] M. Biedermann, P. Haase-Aschoff, K. Grob, Wax ester fraction of edible oils: Analysis by on-line LC-GC-MS and GC x GC-FID, *Eur. J. Lipid Sci. Technol.* 110 (2008) 1084–1094.
- [90] M. Amelio, R. Rizzo, F. Varazini, Separation of wax esters from olive oils by high-performance liquid chromatography, *J. Am. Oil Chem. Soc.* 70 (1993) 793–796.
- [91] C. Crews, C. Pye, R. Macarthur, An improved rapid stigmastadiene test to detect addition of refined oil to extra virgin olive oil, *Food Res. Int.* 60 (2014) 117–122.
- [92] European Commission, Reglamento (CE) No 396/2005 del Parlamento Europeo

- y del Consejo, de 23 de febrero de 2005 relativo a los límites máximos de residuos de plaguicidas en alimentos y piensos de origen vegetal y animal y que modifica la Directiva 91/414/CEE del Consejo, Off. J. Eur. Union, L 70, P. 1–16. (2005).
- [93] European Commission, Reglamento de ejecución (UE) N° 400/2014 de la Comisión, de 22 de abril de 2014, relativo a un programa plurianual coordinado de control de la Unión para 2015, 2016 y 2017 destinado a garantizar el respeto de los límites máximos de residuos de plaguicidas, Off. J. Eur. Union, L119. (2014) 44–56.
- [94] European Commission, Reglamento de ejecución (UE) 2016/662 de la comisión, de 1 de abril de 2016, relativo a un programa plurianual coordinado de control de la Unión para 2017, 2018 y 2019 destinado a garantizar el respeto de los límites máximos de residuos de plaguicidas en , Off. J. Eur. Union, L115. (2016) 2–15.
- [95] Codex Alimentarius Council, CODEX Alimentarius: Manual del procedimiento, actualizado a la 39ª sesión, Roma, Ital. (2016). <http://www.fao.org/fao-who-codexalimentarius/procedures-strategies/es/>.
- [96] K.A. Rubinson, J.F.. Rubinson, Cromatografía de líquidos, 4th ed., Madrid (España), 1994.
- [97] J. Růžička, E.H. Hansen, Flow Injection Analysis. Part I. A New Concept of Fast Continuous Flow Analysis, Anal. Chim. Acta. 78 (1975) 145–157.
- [98] J. Růžička, E.H. Hansen, Peer Reviewed: Flow Injection Analysis: From Beaker to Microfluidics., Anal. Chem. 72 (2000) 212 A-217 A.
- [99] R.C. Prados-Rosales, J.L. Luque-García, M.D. Luque De Castro, Valves and flow injection manifolds: An excellent marriage with unlimited versatility, Anal. Chim. Acta. 480 (2003) 181–192.
- [100] M.D. Luque de Castro, Análisis por Inyección en Flujo, Primera, Dpto de Química Analítica, UCO, Córdoba, 1984.
- [101] J.F. García-Reyes, P. Ortega-Barrales, A. Molina-Díaz, Development of a Single Fluorescence-Based Optosensor for Rapid Simultaneous Determination of Fungicides Benomyl and Thiabendazole in Waters and Commercial Formulations, J. Agric. Food Chem. 52 (2004) 2197–2202.
- [102] T. Pérez-Ruiz, C. Martínez-Lozano, V. Tomás, O. Val, Fluorimetric flow-injection determination of hydroperoxides in foodstuffs, Food Chem. 46 (1993) 301–305.
- [103] J.A. García-Mesa, M.D. Luque de Castro, M. Valcárcel, Coupled Robot-Flow Injection Analysis System, Anal. Chem. 65 (1993) 3540–3542.
- [104] M.P. Cañizares, M.T. Tena, M.D. Luque De Castro, On line coupling of a liquid-liquid extraction flow-reversal system to a spectrophotometric flow-through sensor for the determination of polyphenols in olive oil, Anal. Chim. Acta. 323 (1996) 55–62.
- [105] N.S. Thomaidis, C.A. Georgiou, Edible oil analysis by flow injection, Lab. Autom. Inf. Manag. 34 (1999) 101–114.
- [106] N.S. Thomaidis, C.A. Georgiou, Direct parallel flow injection multichannel

- spectrophotometric determination of olive oil iodine value, *Anal. Chim. Acta.* 405 (2000) 239–245.
- [107] J.M. Ruiz-Jiménez, M.D. Luque De Castro, Flow injection manifolds for liquid-liquid extraction without phase separation assisted by ultrasound, *Anal. Chim. Acta.* 489 (2003) 1–11.
- [108] B. Saad, W.T. Wai, B.P. Lim, M.I. Saleh, Flow injection determination of peroxide value in edible oils using triiodide detector, *Anal. Chim. Acta.* 565 (2006) 261–270.
- [109] C.C. Crispino, B.F. Reis, Development of an automatic photometric titration procedure to determine olive oil acidity employing a miniaturized multicommuted flow-batch setup, *Anal. Methods.* 6 (2014) 302–307.
- [110] F.J. Krug, H. Bergamin Filho, E.A.G. Zagatto, Commutation in flow injection analysis, *Anal. Chim. Acta.* 179 (1986) 103–118.
- [111] K. Trojanowicz, M., Kolacinska, Recent advances in flow injection analysis, *Analyst.* 141 (2016) 2085–2139.
- [112] M. Trojanowicz, Molecular spectroscopy detection, in: M. Trojanowicz (Ed.), *Flow Inject. Anal. Instrum. Appl.*, World Scientific Publishing, Singapore, 2000: pp. 1–67.
- [113] A. Molina-Díaz, J.F. García-Reyes, Luminescence Detection in Flow Analysis, in: M. Trojanowicz (Ed.), *Adv. Flow Anal.*, Wiley-VCH Verlag GmbH, Weinheim, 2008: pp. 345–393.
- [114] A. Christodouleas, D., Fotakis, C., Economou, K., Papadopoulos, M., Timotheu-Potamia, M., Calokerinos, Flow-based methods with chemiluminescence detection for food and environmental analysis: A review, *Anal. Lett.* 44 (2011) 176–215.
- [115] M.J. Navas, A.M. Jiménez, Chemiluminescence methods in olive oil analysis, *J. Amer. Oil Chem. Soc.* 84 (2007) 405–411.
- [116] X. Zhu, J., Qin, M., Liu, S., Liu, Z., Yang, J., Hu, Incorporation of flow injection analysis with dual-wavelength overlapping resonance Rayleigh scattering for rapid determination of malachite green and its metabolite in fish, *Spectrochim. Acta - Part A Mol. Biomol. Spectrosc.* 130 (2014) 90–95.
- [117] L.P. Acosta, G., Talio, M.C., Luconi, M.O., Hinze, W.L., Fernández, Fluorescence method using on-line sodium cholate cocervate surfactant mediated extraction for the flow injections analysis of Rhodamine B, *Talanta.* 129 (2014) 516–522.
- [118] M. Catala Icardo, J. V. García Mateo, J. Martínez Calatayud, Multicommutation as a powerful new analytical tool, *Trends Anal. Chem.* 21 (2002) 366–378.
- [119] F.R.P. Rocha, B.F. Reis, E.A.G. Zagatto, J.L.F.C. Lima, R.A.S. Lapa, J.L.M. Santos, Multicommutation in flow analysis: concepts, applications and trends, *Anal. Chim. Acta.* 468 (2002) 119–131.
- [120] E. Mariotti, M. Mascini, Determination of extra virgin olive oil acidity by FIA-titration, *Food Chem.* 73 (2001) 235–238.
- [121] V. Papadimitriou, G.A. Maridakis, T.G. Sotiroudis, A. Xenakis, Antioxidant



- activity of polar extracts from olive oil and olive mill wastewaters: An EPR and photometric study, *Eur. J. Lipid Sci. Technol.* 107 (2005) 512–520.
- [122] E. Hoffmann, V. Stroobant, *Mass spectrometry: Principles and applications*, Third, Wiley, 2007.
- [123] R.B. Cole, *Electrospray and MALDI Mass Spectrometry: Fundamentals, Instrumentation, Practicalities, and Biological Applications*. Second Edition, Wiley, Hoboken, New Jersey (USA), 2010.
- [124] Cooks RG, Ouyang Z, Takats Z, Wiseman JM. Detection Technologies. Ambient mass spectrometry. *Science* 2006; 311:1566–70.
- [125] Venter A, Nefliu M, Cooks RG. Ambient desorption ionization mass spectrometry. *Trends Anal Chem* 2008;27:284–90.
- [126] Harris GA, Galhena AS, Fernández FM. Ambient sampling/ionization mass spectrometry: applications and current trends. *Anal Chem* 2011;83:4508–38.
- [127] Juan F. García-Reyes, Bienvenida Gilbert-López, Ana Agüera, Amadeo R. Fernández-Alba, and Antonio Molina-Díaz, The Potential of Ambient Desorption Ionization Methods Combined with High-Resolution Mass Spectrometry for Pesticide Testing in Food. In Amadeo R. Fernandez-Alba, editor: *Comprehensive Analytical Chemistry*, Vol. 58, Elsevier, 2012, pp. 339-366. ISBN: 978-0-444-53810-9.
- [128] B.A. Thomson, J. V. Iribarne, Field induced ion evaporation from liquid surfaces at atmospheric pressure, *J. Chem. Phys.* 71 (1979) 4451.
- [129] J. V. Iribarne, P.J. Dziedzic, B.A. Thomson, Atmospheric pressure ion evaporation-mass spectrometry, *Int. J. Mass Spectrom. Ion Phys.* 50 (1983) 331–347.
- [130] J.H. Gross, *Mass Spectrometry. A textbook*, First Edition, Springer, New York, 2008.
- [131] B.M. Ham, *Even electron mass spectrometry with biomolecule applications*, First, Wiley, 2008.
- [132] H. Wang, J. Liu, R. G. Cooks and Z. Ouyang, Paper spray for direct analysis of complex mixtures using mass spectrometry, *Angew. Chem. Int. Ed.*, 49 (2010) 877-880.
- [133] U. Kogelschatz, B. Eliasson, W. Egli, From ozone generators to flat television screens: history and future potential of dielectric-barrier discharges\*, *Pure Appl. Chem.* 71 (1999) 1819–1828.
- [134] F. Paschen, Über die zum Funkenübergang in Luft, Wasserstoff und Kohlensäure bei verschiedenen Drucken erforderliche Potentialdifferenz, *Ann. Phys.* 273 (1889) 69–75.
- [135] J.D. Harper, N.A. Charipar, C.C. Mulligan, X. Zang, R.G. Cooks, Z. Ouyang, Low-Temperature Plasma Probe for Ambient Desorption Ionization, *Anal. Chem.* 80 (2008) 9097–9104.
- [136] M. Miclea, K. Kunze, G. Musa, J. Franzke, K. Niemax, The dielectric barrier discharge: a powerful microchip plasma for diode laser spectrometry, *Spectrochim. Acta Part B At. Spectrosc.* 56 (2001) 37–43.

- [137] A. Michels, S. Tombrink, W. Vautz, M. Miclea, J. Franzke, Spectroscopic characterization of a microplasma used as ionization source for ion mobility spectrometry, *Spectrochim. Acta Part B At. Spectrosc.* 62 (2007) 1208–1215.
- [138] W. Vautz, A. Michels, J. Franzke, Micro-plasma: a novel ionisation source for ion mobility spectrometry, *Anal. Bioanal. Chem.* 7 (2008) 2609–2615.
- [139] S.B. Olenici-Craciunescu, A. Michels, C. Meyer, R. Heming, S. Tombrink, W. Vautz, J. Franzke, Characterization of a capillary dielectric barrier plasma jet for use as a soft ionization source by optical emission and ion mobility spectrometry, *Spectrochim. Acta Part B At. Spectrosc.* 64 (2009) 1253–1258.
- [140] S. Brandt, A. Schütz, F.D. Klute, J. Kratzer, J. Franzke, Dielectric barrier discharges applied for optical spectrometry, *Spectrochim. Acta Part B At. Spectrosc.* 123 (2016) 6–32.
- [141] F.D. Klute, A. Michels, A. Schu, C. Vadla, V. Horvatic, J. Franzke, Capillary Dielectric Barrier Discharge: Transition from Soft Ionization to Dissociative Plasma, *Anal. Chem.* 88 (2016) 4701–4705.
- [142] A. Schütz, F.D. Klute, S. Brandt, S. Liedtke, G. Jestel, J. Franzke, Tuning Soft Ionization Strength for Organic Mass Spectrometry, *Anal. Chem.* 88 (2016) 5538–5541.
- [143] F.M. Penning, Über Ionisation durch metastabile Atome, *Naturwissenschaften.* 15 (1927) 818.
- [144] H.E. Wagner, R. Brandenburg, K. V. Kozlov, A. Sonnenfeld, P.A. Michel, J.F. Behnke, The barrier discharge: basic properties and applications to surface treatment, *Vacuum.* 71 (2003) 417–436.
- [145] S. Müller, T. Krähling, D. Veza, V. Horvatic, C. Vadla, J. Franzke, Operation modes of the helium dielectric barrier discharge for soft ionization, *Spectrochim. Acta Part B At. Spectrosc.* 85 (2013) 104–111.
- [146] J.C. Wolf, L. Gyr, M.F. Mirabelli, M. Schaer, P. Siegenthaler, R. Zenobi, A Radical-Mediated Pathway for the Formation of  $[M + H]^+$  in Dielectric Barrier Discharge Ionization, *J. Am. Soc. Mass Spectrom.* 27 (2016) 1468–1475.
- [147] V.L. Singleton, R. Orthofer, R.M. Lamuela-Raventós, Analysis of total phenols and other oxidation substrates and antioxidants by means of folin-ciocalteu reagent, *Methods Enzymol.* 299 (1998) 152–178.
- [148] S. Hrnčirik, K., Fritsche, Comparability and reliability of different techniques for the determination of phenolic compounds in virgin olive oil., *Eur J Lipid Sci Technol.* 106 (2004) 540–549.
- [149] B. Bayram, T. Esatbeyoglu, N. Schulze, B. Ozcelik, J. Frank, G. Rimbach, Comprehensive Analysis of Polyphenols in 55 Extra Virgin Olive Oils by HPLC-ECD and Their Correlation with Antioxidant Activities, *Plant Foods Hum. Nutr.* 67 (2012) 326–336.
- [150] V. Stepanyan, A. Arnous, C. Petrakis, P. Kefalas, A.C. Calokerinos, Chemiluminescent evaluation of peroxide value in olive oil, *Talanta.* 65 (2005) 1056–1058.
- [151] B. Gilbert-López, Z.L. Valencia-Reyes, V.M. Yufra-Picardo, J.F. García-Reyes,

- N. Ramos-Martos, A. Molina-Díaz, Determination of polyphenols in commercial extra virgin olive oils from different origins (Mediterranean and South American countries) by liquid chromatography–electrospray Time-of-Flight mass spectrometry, *Food Anal. Methods*. 7 (2014) 1824–1833.
- [152] AENOR, Aceites y grasas de origen animal y vegetal. Determinación del índice de peróxido. Determinación del punto final yodométrico (visual) (ISO 3690:2007, versión corregida 2009-05-15), (2009).
- [153] AENOR, Aceites y grasas de origen animal y vegetal. Determinación del índice de peróxido. Determinación del punto final potenciométrico (ISO 27107:2008, versión corregida 2009-05-15), (2010).
- [154] S. Bezzi, S. Loupassaki, C. Petrakis, P. Kefalas, A.C. Calokerinos, Evaluation of peroxide value of olive oil and antioxidant activity by luminol chemiluminescence, *Talanta*. 77 (2008) 642–646.
- [155] M. Grossi, G. Di Lecce, M. Arru, T. Gallina-Toschi, B. Riccò, An opto-electronic system for in-situ determination of peroxide value and total phenol content in olive oil, *J. Food Eng.* 146 (2015) 1–7.
- [156] S. Armenta, S. Garrigues, M.D. de la Guardia, Determination of edible oil parameters by near infrared spectrometry, *Anal. Chim. Acta*. 596 (2007) 330–337.
- [157] C. Pizarro, I. Esteban-Díez, S. Rodríguez-Tecedor, J.M. González-Sáiz, Determination of the peroxide value in extra virgin olive oils through the application of the stepwise orthogonalisation of predictors to mid-infrared spectra, *Food Control*. 34 (2013) 158–167.
- [158] A. Kamal-Eldin, S. Görgen, J. Pettersson, A.-M. Lampi, Normal-phase high-performance liquid chromatography of tocopherols and tocotrienols, *J. Chromatogr. A*. 881 (2000) 217–227.
- [159] H. Chen, M. Angiuli, C. Ferrari, E. Tombari, G. Salvetti, E. Bramanti, Tocopherol speciation as first screening for the assessment of extra virgin olive oil quality by reversed-phase high-performance liquid chromatography/fluorescence detector, *Food Chem.* 125 (2011) 1423–1429.
- [160] S.M. Bakre, D.K. Gadmale, R.B. Toche, V.B. Gaikwad, Rapid determination of alpha tocopherol in olive oil adulterated with sunflower oil by reversed phase high-performance liquid chromatography, *J. Food Sci. Technol.* 52 (2014) 3093–3098.
- [161] H.F. Ayyildiz, Evaluation of new silica-based humic acid stationary phase for the separation of tocopherols in cold-pressed oils by normal-phase high-performance liquid chromatography, *J. Sep. Sci.* 38 (2015) 813–820.
- [162] Q. Gu, X. Yi, Z. Zhang, H. Yan, J. Shi, H. Zhang, Y. Wang, J. Shao, A facile method for simultaneous analysis of phytosterols, erythrodiol, uvaol, tocopherols and lutein in olive oils by LC-MS, *Anal. Methods*. 8 (2016) 1373–1380.
- [163] M.E. Escuderos, A. Sayago, M.T. Morales, R. Aparicio, Evaluation of  $\alpha$ -tocopherol in virgin olive oil by a luminiscent method, *Grasas Y Aceites*. 60 (2009) 336–342.

- [164] R. Goodacre, S. Vaidyanathan, G. Bianchi, D.B. Kell, Metabolic profiling using direct infusion electrospray ionisation mass spectrometry for the characterisation of olive oils, *Analyst*. 127 (2002) 1457–1462.
- [165] R.R. Catharino, R. Haddad, L.G. Cabrini, I.B.S. Cunha, A.C.H.F. Sawaya, M.N. Eberlin, Characterization of vegetable oils by electrospray ionization mass spectrometry fingerprinting: Classification, quality, adulteration, and aging, *Anal. Chem.* 77 (2005) 7429–7433.
- [166] J.L. Gómez-Ariza, A. Arias-Borrego, T. García-Barrera, R. Beltran, Comparative study of electrospray and photospray ionization sources coupled to quadrupole time-of-flight mass spectrometer for olive oil authentication, *Talanta*. 70 (2006) 859–869.
- [167] M.J. Lerma-García, J.M. Herrero-Martínez, E.F. Simó-Alfonso, G.A. Lercker, L. Cerretani, Evaluation of the oxidative status of virgin olive oils with different phenolic content by direct infusion atmospheric pressure chemical ionization mass spectrometry, *Anal. Bioanal. Chem.* 395 (2009) 1543–1550.
- [168] J. de O. Alves, W.B. Neto, H. Mitsutake, P.S.P. Alves, R. Augusti, Extra virgin (EV) and ordinary (ON) olive oils: distinction and detection of adulteration (EV with ON) as determined by direct infusion electrospray ionization mass spectrometry and chemometric approaches, *Rapid Commun. Mass Spectrom.* 24 (2010) 1875–1880. doi:10.1002/rcm.4590.
- [169] A. Venter, M. Nefliu, R.G. Cooks, Ambient desorption ionization mass spectrometry, *TrAC - Trends Anal. Chem.* 27 (2008) 284–290.
- [170] L. Vaclavik, T. Cajka, V. Hrbek, J. Hajslova, Ambient mass spectrometry employing direct analysis in real time (DART) ion source for olive oil quality and authenticity assessment, *Anal. Chim. Acta.* 645 (2009) 56–63.
- [171] J.F. García-Reyes, F. Mazzotti, J.D. Harper, N.A. Charipar, S. Oradu, O. Zheng, G. Sindona, R.G. Cooks, Direct olive oil analysis by low-temperature plasma (LTP) ambient ionization mass spectrometry, *Rapid Commun. Mass Spectrom.* 23 (2009) 3057–3062.
- [172] F. Mazzotti, L. Di Donna, D. Taverna, M. Nardi, D. Aiello, A. Napoli, G. Sindona, Evaluation of dialdehydic anti-inflammatory active principles in extra-virgin olive oil by reactive paper spray mass spectrometry, *Int. J. Mass Spectrom.* 352 (2013) 87–91.
- [173] B. Alder, L. Greulich, K. Kempe, G. Vieth, Residue analysis of 500 high priority pesticides: better by GC-MS or LC-MS/MS., *Mass Spectrom. Rev.* 25 (2006) 838–865.
- [174] B. Gilbert-López, J.F. García-Reyes, A. Molina-Díaz, Sample treatment and determination of pesticide residues in fatty vegetable matrices: A review, *Talanta*. 79 (2009) 109–128.
- [175] R. López-Blanco, R. Nortes-Méndez, J. Robles-Molina, A. Molina-Díaz, Evaluation of different cleanup sorbents for multiresidue pesticide analysis in fatty vegetable matrices by liquid chromatography tandem mass spectrometry, *J. Chromatogr. A.* 1456 (2016) 89–104.

- [176] B. Gilbert-López, J.F. García-Reyes, A.R. Fernández-Alba, A. Molina-Díaz, Evaluation of two sample treatment methodologies for large-scale pesticide residue analysis in olive oil by fast liquid chromatography-electrospray mass spectrometry, *J. Chromatogr. A.* 1217 (2010) 3736–3747.
- [177] R. López-Blanco, D. Moreno-González, R. Nortes-Méndez, J.F. García-Reyes, A. Molina-Díaz, B. Gilbert-López, Experimental and theoretical determination of pesticide processing factors to model their behavior during virgin olive oil production, *Food Chem.* 239 (2018) 9-16.
- [178] A.R. Parrilla Vázquez, P., Hakme, E., Uclés, S., Cutillas, V., Martínez Galera, M., Mughari, A.R., Fernández-Alba, Large multiresidue analysis of pesticides in edible vegetable oils by using efficient solid-phase extraction sorbents based on quick, easy, cheap, effective, rugged and safe methodology followed by gas chromatography–tandem mass spectrometry, *J. Chromatogr. A.* 1463 (2016) 20–31.







---

*Resultados y  
discusión*









## IV. Resultados y discusión

### IV. 1. Determinación automática de componentes minoritarios del aceite de oliva virgen relacionados con las propiedades antioxidantes (compuestos fenólicos y tocoferoles) y el estado de oxidación (peróxidos), usando sistemas multiconmutados con detección mediante espectroscopía molecular

En esta primera parte se exponen los trabajos desarrollados basados en sistemas automáticos de análisis por inyección en flujo multiconmutados para la determinación de compuestos minoritarios: por una parte, compuestos antioxidantes como compuestos fenólicos y tocoferoles, y peróxidos (expresados como índice de peróxidos, parámetro de calidad), por otra. La determinación del contenido total de compuestos fenólicos y el de tocoferoles arrojan información sobre los compuestos antioxidantes presentes de modo natural en el aceite y a los que se atribuye importantes propiedades saludables y nutricionales. Dicha importancia radica, en primer lugar, en que actúan como antioxidantes naturales frente a la oxidación de ciertos componentes de este apreciado alimento, deteniendo o retrasando los indeseables procesos degradativos asociados a la oxidación. Por otro lado, la ingesta de estos antioxidantes es muy recomendable porque ayudan a combatir los radicales libres que se generan en nuestro organismo (daños para nuestra salud), reaccionando con ellos para estabilizarlos. Por otro lado, el índice de peróxidos funciona como indicador del estado de degradación oxidativa del aceite.

Todos los métodos desarrollados generan muy pocos desechos y minimizan el uso de disolventes, para ser cada vez más respetuosos con el medio ambiente, que son tendencias actuales de la Química Analítica Verde cada vez más apreciadas y valoradas por los laboratorios. Por otra parte, son fácilmente implementables en laboratorios de rutina y aportan velocidad de análisis, simplificación del tratamiento de muestra (caso de tocoferoles y peróxidos), economía y reproducibilidad, eliminando el factor humano como fuente de imprecisión, principalmente en aquellos casos en los que el método oficial se basa en una volumetría, como es el caso de la determinación de peróxidos. Además, conllevan una reducción significativa del consumo de reactivos, disolventes y de desechos originados por muestra analizada.







## Artículo 1: Multicommutated flow injection method for fast photometric determination of phenolic compounds in commercial virgin olive oil samples

### Resumen

Se ha desarrollado un método por inyección en flujo multiconmutado para la determinación de compuestos fenólicos/antioxidantes en muestras de aceite de oliva virgen. El método se basa en el efecto inhibitor que ejercen las especies antioxidantes del aceite de oliva virgen (a partir de un extracto hidroalcohólico de la muestra) sobre la formación del radical catión DMPD<sup>•+</sup> generado a partir de la reacción de oxidación de N,N-dimetil-p-fenilendiamina con Fe(III) en medio ácido. La inhibición de la señal por las especies fenólicas y otros antioxidantes presentes es proporcional a su concentración en la muestra de aceite de oliva. La absorbancia se registró a 515 nm por medio de un espectrómetro modular de fibra óptica y se utilizó oleuropeína como patrón para la determinación de fenoles. Se observó una respuesta lineal en el rango de 250 a 1000 mg oleuropeína kg<sup>-1</sup> para compuestos fenólicos, que incluye todo el intervalo de concentraciones observado en los aceites de oliva virgen extra comerciales usados en el presente estudio. También se usó el ácido 6-hidroxi-2,5,7,8-tetrametilcroman-2-carboxílico (trolox) como estándar de referencia para evaluar el contenido total de antioxidantes (trolox es un compuesto muy utilizado para este propósito en otros tipos de muestras). Se encontró una respuesta lineal del sistema entre 125 y 375 mg de trolox kg<sup>-1</sup> para contenido total de antioxidantes, que cubría también todo el intervalo de valores de los aceites estudiados. Los resultados obtenidos usando trolox están muy bien correlacionados con los contenidos encontrados de oleuropeína, por lo que estos pueden ser evaluados a partir de aquellos y viceversa, son mutuamente interconvertibles.

El tratamiento de muestra consistió en una rápida extracción líquido-líquido usando un bajo volumen de la misma utilizando MeOH al 60% en agua. Las cinco válvulas solenoides de tres vías utilizadas para la manipulación multiconmutada de las disoluciones de muestra y reactivos fueron controladas por una interfaz electrónica de fabricación propia y cuyo software escrito en Java también fue desarrollado por el grupo. El método auto-



mático propuesto fue aplicado a diferentes muestras comerciales de aceite de oliva virgen extra y los resultados fueron consistentes con los obtenidos por el método convencional Folin Ciocalteu (FC). El método propuesto permite la determinación de compuestos fenólicos/antioxidantes con una drástica reducción del tiempo por análisis (ocho veces inferior) respecto del método convencional de FC.

Talanta 147 (2016) 531–536



Contents lists available at [ScienceDirect](#)

Talanta

journal homepage: [www.elsevier.com/locate/talanta](http://www.elsevier.com/locate/talanta)

## Multicommuted flow injection method for fast photometric determination of phenolic compounds in commercial virgin olive oil samples

Felipe J. Lara-Ortega<sup>a,b</sup>, Francisco J. Sainz-Gonzalo<sup>a</sup>, Bienvenida Gilbert-López<sup>a</sup>, Juan F. García-Reyes<sup>a,b</sup> and Antonio Molina-Díaz<sup>a,b\*</sup>

<sup>a</sup>*Analytical Chemistry Research Group, Department of Physical and Analytical Chemistry, University of Jaén, E-23071 Jaén, Spain*

<sup>b</sup>*Centro de Estudios Avanzados en Olivar y Aceite de Oliva (CEAOAO), University of Jaén,*

*Parque Científico Tecnológico Geolit, E-23620, Mengíbar (Jaén), Spain*

### \* Corresponding author:

Prof. Antonio Molina-Díaz, Analytical Chemistry Research Group, Department of Physical and Analytical Chemistry, University of Jaén, Campus Las Lagunillas edif. B-3, E-23071 Jaén, Spain; Tel.: (+34) 953212147; Fax: (+34) 953212940.

E-mail: [amolina@ujaen.es](mailto:amolina@ujaen.es)

Graphical abstract

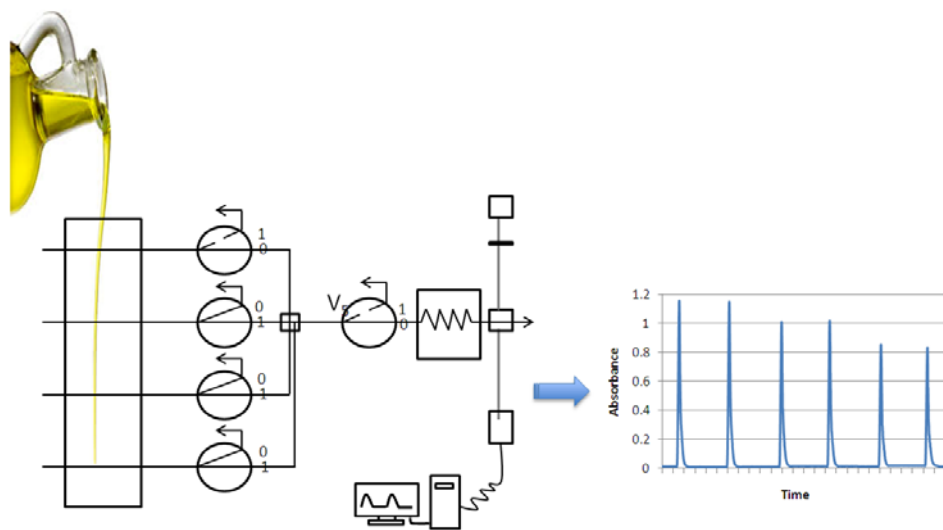

## Abstract

A multicommutated flow injection method has been developed for the determination of phenolic species in virgin olive oil samples. The method is based on the inhibitory effect of antioxidants on a stable and colored radical cation formation from the colorless compound *N,N*-dimethyl-*p*-phenylenediamine (DMPD<sup>•+</sup>) in acidic medium in the presence of Fe(III) as oxidant. The signal inhibition by phenolic species and other antioxidants is proportional to their concentration in the olive oil sample. Absorbance was recorded at 515 nm by means of a modular fiber optic spectrometer. Oleuropein was used as the standard for phenols determination and 6-hydroxy-2,5,7,8-tetramethylchroman-2-carboxylic acid (trolox) was the reference standard used for total antioxidant content calculation. Linear response was observed within the range of 250 to 1000 mg/kg oleuropein, which was in accordance with phenolic contents observed in commercial extra virgin olive oil in the present study. Fast and low-volume liquid-liquid extraction of the samples using 60% MeOH was made previous to their insertion in the flow multicommutated system. The five three-way solenoid valves used for multicommutated liquid handling were controlled by a homemade electronic interface and Java-written software. The proposed approach was applied to different commercial extra virgin olive oil samples and the results were consistent with those obtained by the Folin Ciocalteu (FC) method. Total time for the sample preparation and the analysis required in the present approach can be drastically reduced: the throughput of the present analysis is 8 samples/h in contrast to 1 sample/h of the conventional FC method. The present method is easy to implement in routine analysis and can be regarded as a feasible alternative to FC method.

**Keywords:** Flow injection analysis; multicommutation; olive oil; phenolic compounds determination; antioxidants; Folin-Ciocalteu.

## 1. Introduction

Extra virgin olive oil (EVOO) is a key component of the traditional Mediterranean diet to which health benefits are attributed [1-4] due to its high level of both (i) phenolic compounds with a powerful antioxidant activity (mainly phenols and tocopherols) and (ii) unsaturated fatty acids with a high monounsaturated:polyunsaturated ratio. This EVOO unique feature composition is the responsible of its higher resistance to oxidation compared to the rest of vegetable oils.

Phenols play a key role on the antioxidant activity of virgin olive oil (VOO) as they are regarded as the molecules with the highest potential to block free radicals acting as primary antioxidants by donating a radical hydrogen to alkylperoxyl radicals formed during the initiation step of lipid oxidation so forming a stable radical. On the other hand, they have been recognized as potential nutraceutic compounds for food and pharmaceutical industries [5].

Due to their antioxidant properties, considerable research efforts are being devoted to the phenolic compounds and a plethora of methodologies have been proposed to test antioxidant activity of foods in general [6, 7] including VOO [8, 9] making use of different principles such as ability to scavenge free radicals or measurement of total reducing capacity being 2,2-diphenyl-1-picrylhydrazyl (DPPH), 2,2'-azino-bis(3-ethylbenzothiazoline-6-sulphonic acid) (ABTS), oxygen radical antioxidant capacity (ORAC), ferric reducing ability of plasma (FRAP) and cupric reducing antioxidant capacity (CUPRAC) assays the most commonly used [10-12]. The non-specific colorimetric assay based on the Folin-Ciocalteu reagent is probably the most used procedure for the determination of phenolic species in VOO [13] and other samples. It is a classical method for total phenolic quantitation, based on their reducing ability. Two important drawbacks of this procedure are: a) its low specificity (the color reaction can occur with any oxidizable phenolic hydroxyl group, even with non-phenolic compounds [14]); and b) the labor and time consuming reaction (1-2 hours). Recently, methodological approaches to improve the specificity of the FC assay for total phenolic content determinations have been reviewed [15]. For extra virgin olive oil (EVOO) samples, some correlations have been established between FC assay and other antioxidant assays, as DPPH, ABTS and ORAC, being the

best correlation obtained between FC and ABTS [11]. All these assays are also time consuming either for the reaction or for the radical formation.

In spite of the efforts devoted to the development methodologies for the determination of phenols/antioxidants contents in VOO, as far as we know, there is no simple test method able to reflect the antioxidant profile of a VOO sample, probably due to the complexity of the antioxidant processes in food samples. Therefore, the development of new methods for evaluating phenols/antioxidants of VOO samples that may circumvent some of the drawbacks of currently available methods is of great interest.

In this sense, some attempts to automate FC method for the determination of phenolic compounds in olive oil have been performed [16-18] based on: (i) the combination of robotics and Flow Injection Analysis (FIA) to carry out the unattended FC assay on the samples [19], which takes 30 min. per analysis; (ii) on-line liquid-liquid extraction using iterative flow reversal approach coupled to a flow-through spectrophotometric sensor with increased sampling rates [20]; and (iii) ultrasound-assisted liquid-liquid extraction without phase separation [21]. Although these methods include the automatic sample extraction step of phenols, they are either very expensive [20] or tedious and not robust enough [21] to be applied to routine analysis. Nevertheless, scarce attention has been paid to the automation of alternative assays based on color development reactions for VOO samples. N,N-dimethyl-p-phenylenedimine (DMPD) has been proposed for measurement of antioxidant activity of wines based on the absorbance inhibition of its radical cation  $DMPD^+$ [22], which were comparable to those by other available procedures such as ABTS assay. Additionally, antioxidant activity obtained by DMPD assay was well correlated with the phenolic content calculated by FC method. However, DPMD assay has been scarcely investigated for antioxidant activity and total phenolic content measurements in olive oil [23].

Multicommutated flow analysis (MCFIA) is based on the use of a set of computer-controlled 3-way solenoid valves to design flow manifolds, allowing to increase flow system versatility with low both sample and reagent consumptions (reagents are used in the minimum amounts and just in the necessary moment of the analytical procedure) and low waste volumes. MCFIA approach can be considered as an evolution of flow

injection analysis (FIA) towards Green Analytical Chemistry [24, 25]. Examples of applications of MCFIA can be found in [24]. Recently, a chemiluminescence procedure based on a multicommutated flow system has been described for phenolic compounds in several food samples, including olive oil [26]. The procedure is simple and attractive for some types of food matrices, however the sample treatment for olive oil matrix is complex and time consuming and involves relatively high solvent volume consumption.

The aim of this article is to investigate the use of DMPD<sup>+</sup> for the estimation of total phenolic content in EVOO samples by means of a multicommutated flow injection analysis (MCFIA) procedure. MCFIA is proposed as a fast and automatic alternative to the classical FC procedure, easy to implement in routine laboratories.

## 2. Experimental

### 2.1. Reagents and solutions

All experiments were performed with analytical-reagent grade reagents. A Milli-Q-Plus ultra-pure water system from Millipore (Milford, MA, USA) was used throughout the study to obtain highly pure water for the preparation of standard solutions, samples and reagents. Sodium acetate (AcNa), methanol HPLC grade, *N,N*-dimethyl-*p*-phenylenediamine (DMPD), 6-hydroxy-2,5,7,8-tetramethylchroman-2-carboxylic acid (trolox), gallic acid, tyrosol and Folin-Ciocalteu reagent were purchased from Sigma-Aldrich (Madrid, Spain). Oleuropein was from Extrasynthese (Genay Cedex, France), Fe (III) chloride, hydrochloric acid and sodium carbonate were obtained from Panreac (Barcelona, Spain).

*Carrier solution:* Working solution of acetate buffer 0.1 mol L<sup>-1</sup> was prepared by dissolving sodium acetate in milli-Q water and adjusting the pH to 5.25 using diluted HCl solution.

*Fe(III) solutions:* Stock solution of 50 mmol L<sup>-1</sup> from FeCl<sub>3</sub> was prepared with milli-Q water. Daily working solution of 1 m mol L<sup>-1</sup> was prepared by appropriate dilution with milliQ water and acidified up to pH 1 with HCl.

*DMPD solution:* Working solution of 4 mmol L<sup>-1</sup> from DMPD was daily freshly prepared with milli-Q water. This solution is stable during 4 hours at room temperature (see section 3.1.1).

## 2.2. Reference method for the determination of total phenolic content of EVOO samples

The total phenolic content of EVOO samples was determined by using the Folin-Ciocalteu reagent [16, 27]. First, the phenolic compounds were extracted from samples using a mixture of methanol/water. Then, the obtained extract is mixed with the Folin-Ciocalteu reagent to obtain a colored solution.

*2.2.1. Extraction procedure:* 10 g of the sample of EVOO were weighted (with a precision of 0.1 g) and dissolved in 50 mL of hexane. The mixture is loaded into a 100-mL separatory funnel to undergo a three step liquid-liquid extraction. First, 10 mL of a solution of methanol/water (60:40 v/v) were added and the mixture was vigorously shaken for 2 min; then the hydroalcoholic phase (lower) was collected in a 50-mL volumetric flask. This extraction step was repeated two times more, being all the hydroalcoholic phases combined in the same flask. Finally, the volumetric flask is made up to the mark with distilled water.

*2.2.2. Colorimetric Folin-Ciocalteu reaction:* The chromogenic reaction is carried out in a 50-mL volumetric flask. First, 30 mL of distilled water were added, followed by 5 mL of the EVOO extract and 2.5 mL of Folin-Ciocalteu reagent. The mixture is shaken to homogenize. Three minutes later, 5 mL of a sodium carbonate saturated solution in water were added and the flask was made to the mark with distilled water. Then, the homogenized mixture was left to stand for 1h at room temperature. The absorbance of the resulting blue-colored solution was finally measured at 765 nm against blank solution. The concentration of the total phenolic content was determined by a comparison with the values obtained with standard solutions of gallic acid (ranging from 1 – 10 mg/L) subjected to the same procedure applied to sample extracts.



### **2.3. Liquid-liquid extraction of phenolic compounds from olive oil samples**

The extraction of phenolic compounds was carried out in test tubes of 10-mL volume. First, 4 g of EVOO sample were weighted (with a precision of 0.1 g) and 2 mL of hexane were added. Then, 2 mL of a solution of methanol/water (60:40 v/v) were added, the mixture was vigorously shaken for 1 min in a Vortex. The next step was to centrifuge the mixture at 3500 rpm during 5 min in order to separate two phases. Using a Pasteur pipette, the lower hydroalcoholic phase was transferred to a second test tube. A second extraction step was carried out with other 2 mL of 60% methanol solution and the hydroalcoholic phase is collected with the previous one. Any oily residue from the extract was eliminated (centrifuging if it is necessary). Finally, the extract was transferred to a 10-mL volumetric flask and made up to the mark with 60% MeOH. Thus, the sample was analyzed in a 60% MeOH solution with a dilution factor of 1:2.5 (mL extract/g olive oil), which is taken into account for the expression of the results in mg phenolic compounds per kg olive oil.

### **2.4. Modular Fiber Optic Spectrophotometer**

An Ocean Optics HR2000+ (USA) high-resolution miniature fiber optic spectrometer was used to monitor the absorbance spectra. This spectrometer was connected to a PC via USB port. SpectraSuite Java-based spectroscopy software (Ocean Optics, USA) was used for data acquisition. The connection among the modules was made with solarization resistant optical fibers QP600-1-SR-BX (Ocean Optics). The fiber optic spectrophotometer was composed by different modules: a light source, a filter to set the selected wavelength, optical fibers, a cuvette holder, the spectrometer detector and finally a PC with the appropriate software. In the present work, a deuterium-halogen light source DH-2000 from Ocean Optics (210-1500 nm) was used. A filter LVF-HL (Ocean Optics) was set at a center wavelength of 515 nm (bandwidth ~ 25 nm) (maximum absorbance wavelength, see spectrum in Fig. 1 and placed in a FHS-LVF (Ocean Optics) filter holder. A cuvette holder CUV-ALL-UV (Ocean Optics) is used to place the Hellma 178.011-OS flow cell (80  $\mu$ L internal volume and a 10 mm light path length). Both filter and cuvette were covered with black boxes in order to prevent any interference from ambient light.

Since absorbance difference measurements are accomplished (the signal from the blank reagent minus the signal in the presence of the sample), there was no need to compensate for the light source and spectrometer drift (the specifications of the portable instrument are solid enough to provide performance approaching benchtop spectrometers).

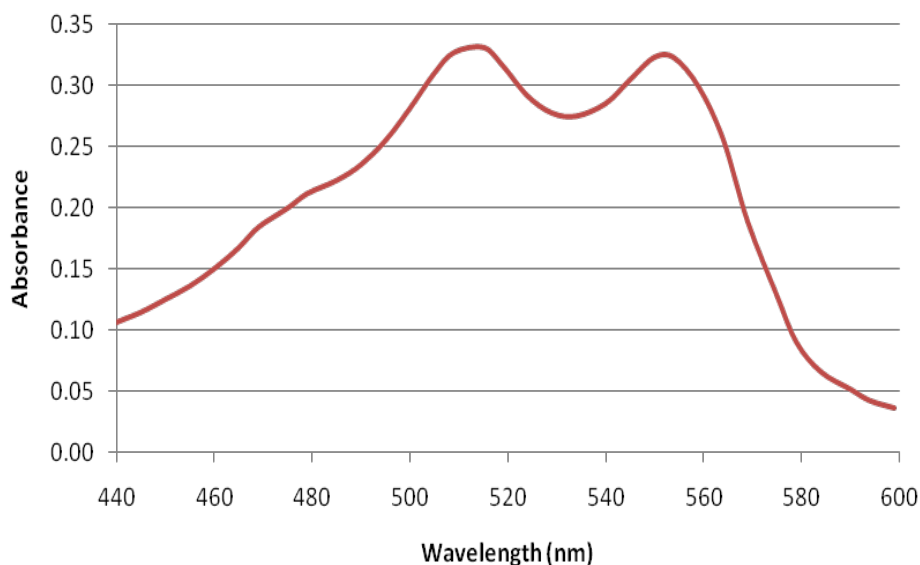

**Figure 1.** Spectrum of the reagent in the visible region. Experimental conditions: [DMDP] = 1 mM and [Fe<sup>3+</sup>] = 0.25 mM in aqueous solution. Working wavelength: 515 nm (maximum absorbance).

## 2.5. Multicommutated FIA (MCFIA) system

A scheme of the flow system is depicted in Fig. 2, including a schematic configuration of the modular fiber optic spectrometer. A four-channel Gilson Miniplus-3 peristaltic pump (Villiers Le Bel, France) with rate selector and Watson Marlow (Cornwall, UK) solvent resistant manifold tubing, Grey/Grey, ID 1.29 mm was used to propel de solutions through the flow network. Five three-way solenoid valves type 161T031 (NResearch, Northampton, UK) were employed to manage the flow pathway, making the solutions either to recirculate to their vessels or, alternatively driving them to the detector through the MCFIA manifold. An electronic interface, based on the ULN 2803 universal integrated circuit chip (available from any electronic circuit components supplier) was used

to control the valves, which were operated with an electric potential of 12V and a direct current of 100 mA. The homemade software for controlling the solenoid valves was developed in Java. Teflon tubing (0.8 mm i.d.) and methacrylate connections were used.

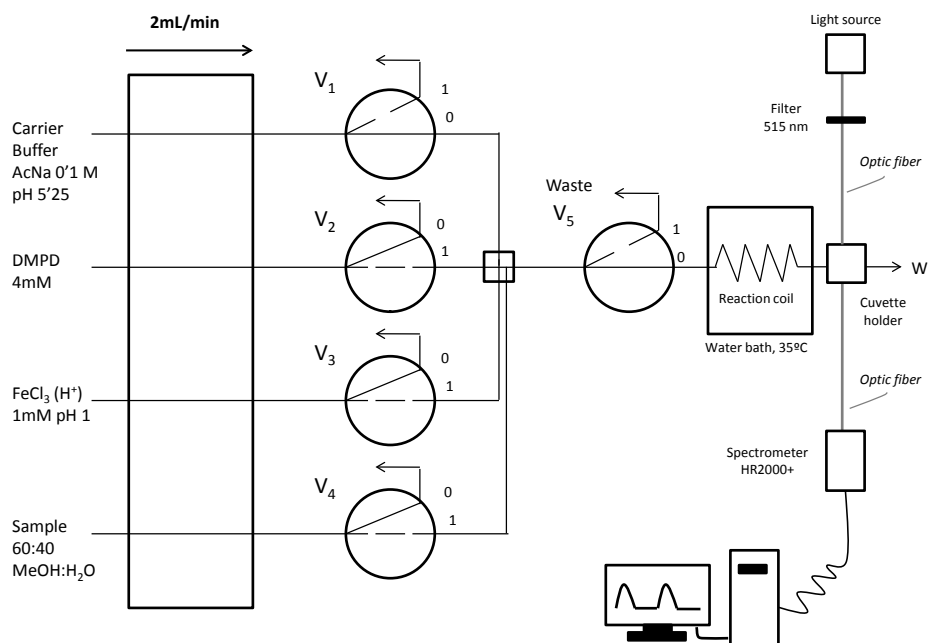

Figure 2. Flow network scheme.

## 2.6. General procedure

When an individual solenoid valve is switched off, the solution flows through the exit #0 (Fig. 2). On the other hand, when the solenoid valve is switched on, the solution flows through the exit #1. In the initial status, the carrier solution ( $V_1 = \text{OFF}$ ) and the reagents ( $V_2$  and  $V_3 = \text{ON}$ ) are allowed to flow through the cuvette during 1 min, in order to prime the entire flow network. Then, the first sample is inserted by switching on the valves  $V_4$  and  $V_5$  during 5 s and 10 s, respectively. At this point, the system is ready for the analysis of a set of samples sequence. The valves switching procedure is shown in Table 1.

Table 1. Valve switching scheme

Step	V1	V2	V3	V4	V5	Analysis time	Volume consumption	Description
1	0	1	1	0	0	0 s	Sample: 166.67 $\mu$ L DMPD: 200 $\mu$ L Fe3+: 200 $\mu$ L	Sample injection
	0	1	1	1	0	1 s		
	0	0	0	0	0	6 s		
2	0	0	0	1	1	24 s	Sample: 166.67 $\mu$ L DMPD: 0 $\mu$ L Fe3+: 0 $\mu$ L	Insertion of the subsequent sample in the system, while the previous one reach the reaction coil
	0	0	0	0	1	29 s		
	0	0	0	0	0	34 s		
3	0	0	0	0	0	34 s	Sample: 0 $\mu$ L DMPD: 0 $\mu$ L Fe3+: 0 $\mu$ L	Stop the pump
4							Sample: 0 $\mu$ L DMPD: 0 $\mu$ L Fe3+: 0 $\mu$ L	Reaction takes place in the reaction coil
5	0	0	0	0	0	5 min : 24 s	Sample: 0 $\mu$ L DMPD: 0 $\mu$ L Fe3+: 0 $\mu$ L	Restart the pump
	0	0	0	0	0	5 min : 32 s		Analytical signal start
	0	0	0	0	0	7 min : 19 s		Analytical signal end

The reagents are inserted during 6 s ( $V_2$  and  $V_3 = \text{ON}$ ), while the sample is inserted ( $V_4$ ) during 5 s, in order to allow the mixing between whole sample plug and the reagents. Then the mixture flows during 18 s until it reached the thermostated (35 °C) reaction coil (2.5 m length, 0.8 mm id). At this time, the following sample is inserted in the system by switching on the valves  $V_4$  and  $V_5$  during 5 s and 10 s, respectively. Immediately after

this step, either the peristaltic pump is stopped or the carrier solution is recirculated to its vessel ( $V_1 = ON$ ) until running sample reaction (5 min.) is completed. The absolute value of absorbance decrease peak was used as analytical signal. Finally, the carrier flow is restarted and the analytical signal of the colored species is developed. A typical profile of the signal obtained is shown in Figure 3. The time the different valves are operated is too low to yield sample heating. In addition, the time period between two successive sample injections is about 8 min. Thus, heating effect during sample insertion in  $V_4$  could not be observed. No issues related with the presumably Schlieren's effect due to refraction index differences between the sample and carrier compositions were observed.

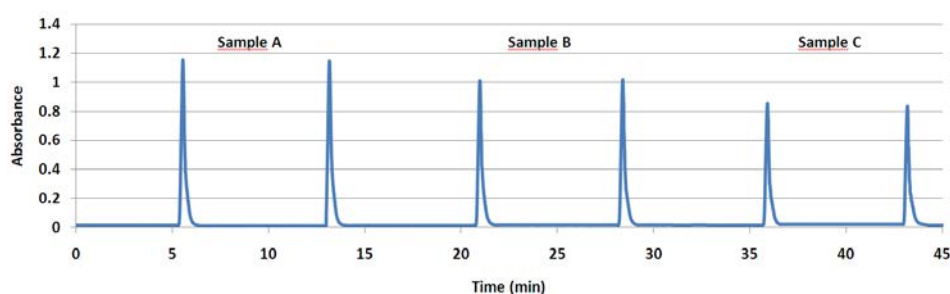

Figure 3. Typical diagram corresponding to duplicate measures of three different EVOO samples.

## 2.7. Statistical analysis

All the data were analyzed using Microsoft Office Excel software, version 2007 (Microsoft Corp., USA). Triplicate measurements were performed in all cases. Linear regression equations, correlation coefficients, standard errors for regression ( $S_{y/x}$ ), intercept ( $S_a$ ) and slope ( $S_b$ ) were also obtained.

## 3. Results and discussion

The present automatic method is based on the use of DMPD, which forms a colored radical cation ( $DMPD^{\bullet+}$ ) in the presence of Fe (III) acting as oxidant in acidic media [22]. Antioxidants, such as phenolic species are able to transfer a hydrogen atom to the radi-

cal, causing the decoloration of the solution. The maximum absorbance wavelength was set at 515 nm.

### 3.1. Chemical variables

#### 3.1.1. Concentration and stability of DMPD radical.

Fogliano et al. reported a DMPD cation radical stability for several hours, using a DMPD:Fe(III) molar ratio of 10:1 in order to avoid a residual presence of ferric ion in the colored solution of DMPD<sup>•+</sup> [22]. In the present work, several tests were implemented keeping DMPD:Fe(III) molar ratio 10:1 (20mM:2mM, 10mM:1mM and 2mM:0.2mM), and additionally, other molar ratios were also assayed. Thus, FeCl<sub>3</sub> concentration was tested in the range 0.2 – 1.0 mM, at a fixed concentration of 10mM DMPD. On the other hand, at a fixed concentration of 1 mM Fe(III), the concentration of DMPD was tested in the range 2 – 10 mM. The decrease in the DMPD<sup>•+</sup> absorbance signal by a constant concentration of gallic acid (150 mg/L), used as model phenol, was monitored for analytical signal optimization. From the results obtained (Fig. 4A and 4B) 1 mM Fe(III) and 4mM DMPD concentrations were selected as the optimum values, as they produced the highest absorbance value decrease. The signal of DMPD<sup>•+</sup> originated in these conditions was stable for, at least, 4 hours at room temperature.

#### 3.1.2. Reaction conditions: temperature and reaction time.

The reaction time at room temperature (DMPD<sup>•+</sup> absorbance decrease produced by the model phenol) reached the best results within 15 min. In order to minimize the necessary reaction time, the effect of the temperature was studied by varying it in the range 20 – 35°C. This had not significant influence on the signal value, however, when working at 35 °C, the reaction time needed could be reduced to 5 min. Thus, the optimum reaction conditions selected were 5 min and 35 °C (Fig. 4C).

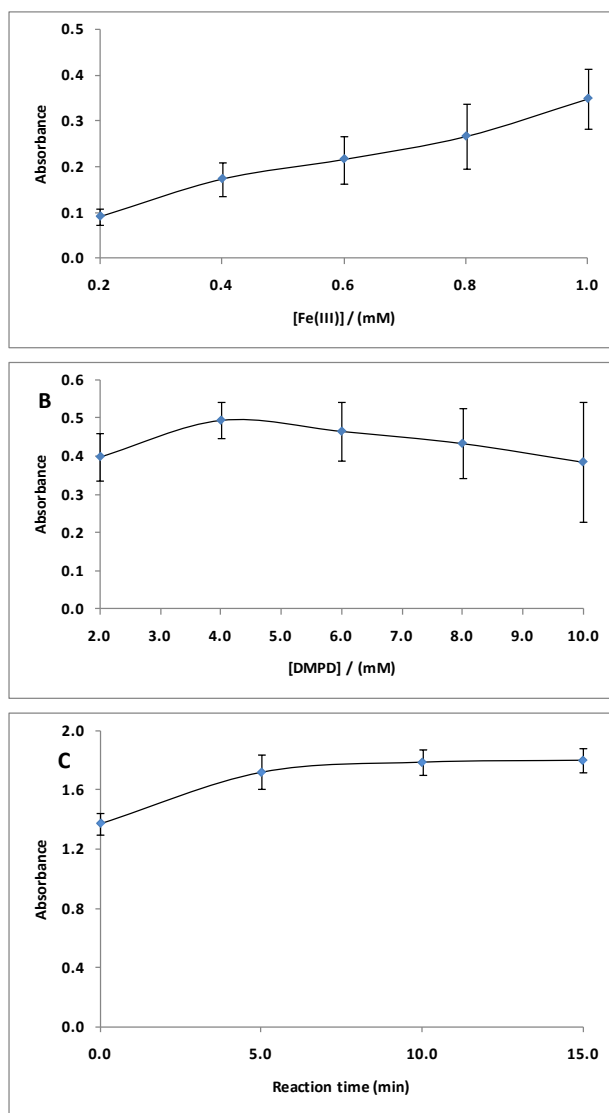

Figure 4. Chemical variables optimization (absolute values of  $\Delta$ Absorbance used as analytical signal): (A) Concentration of Fe (III) was tested in the range 0.2 – 1.0 mM, at a fixed concentration of DMPD 10mM; (B) Concentration of DMPD was tested in the range 2 – 10 mM at a fixed concentration of Fe(III) 1 mM; (C) Reaction time was studied in the range 0 – 10 min at a fixed temperature of 35 °C.

### 3.2. Flow system variables

The flow-rate provided by the peristaltic pump, as well as sample and reagents insertion time (by means of the 3-way solenoid valves) were studied and optimized. The flow-rate was investigated from 1.0 to 2.5 mL/min. As expected, an increase of the flow-rate produced an increase in both the analytical signal and the sampling frequency (due to increased sample volume in the same insertion time). According to results shown in Fig. 5A, a flow rate of 2.0 mL/min. was adopted as the optimum value.

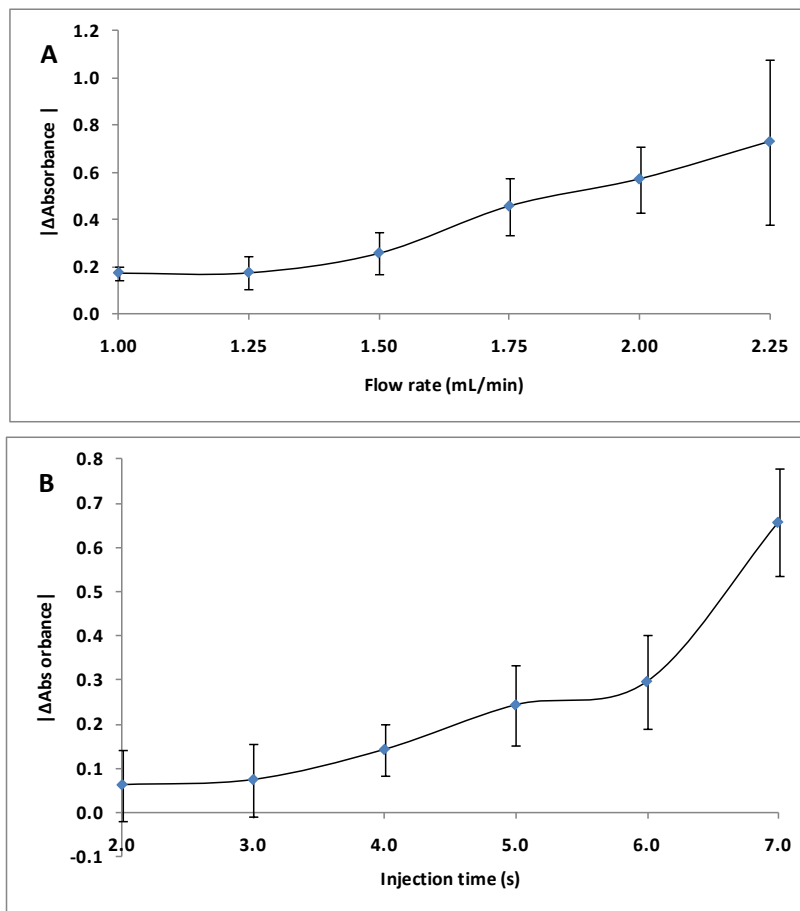

Figure 5. Flow system variables optimization (absolute values of  $\Delta\text{Absorbance}$  used as analytical signal): (A) Flow rate was studied in the range 1.0 – 2.25 mL/min at fixed concentrations of Fe (III) = 1mM and DMPD = 4mM; (B) Sample and reagents injection time was studied in the range 2.0 – 6.0 s at fixed concentrations of Fe (III) = 1mM and DMPD = 4mM.



In a MCFIA network, both sample and reagents volumes are controlled by varying the insertion time by using the appropriate current pulses for the solenoid valves. The studied range for the simultaneous introduction of sample and reagents was varied from 2 to 8 seconds. The decrease in the blank absorbance signal of  $\text{DMPD}^+$  caused by a concentration of phenol (gallic acid, 150 mg/L) was the analytical criterion used for insertion time optimization. For sample insertion values higher than 7 s, the blank solution (60% MeOH analyte free solution) originated the saturation of the signal. Finally, 5 seconds was the chosen insertion time, as a high sample frequency was obtained in these conditions, with satisfactory sensitivity (Fig. 5B).

### 3.3. Figures of merit

Once the operating conditions and parameters were optimized, the analytical performance of the procedure was studied. Four compounds were tested as standards to evaluate total phenolic compounds content in the samples: gallic acid, tyrosol, oleuropein and trolox. Inhibition curves of  $\text{DMPD}^+$  radical formation are shown in Fig. 6. Gallic acid exhibited a great inhibition effect on the  $\text{DMPD}^+$  formation reaction (high decrease of absorbance), but its effect soon became independent on concentration, just for values higher than 100 mg/L. On the other hand, tyrosol showed a very poor inhibitory effect (e.g. practically concentration independent effect), while oleuropein showed a more moderate inhibition trend, closer to the behavior of the VOO samples. Thus, oleuropein (usually an abundant phenol in VOO) was selected as a representative phenol for calibration. The calibration equation (obtained in 60% MeOH solution) was  $y = 0.0013x + 0.420$ , ( $r = 0.9699$ ;  $S_{y/x} = 0.053$ ;  $S_a = 0.065$ ;  $S_b = 0.00024$ ) where  $y$  = absolute value of absorbance decreasing and  $x$  = mg oleuropein/kg olive oil. The linear dynamic range was 250 - 1000 mg oleuropein/kg olive oil. Nevertheless, given the high cost of oleuropein, we also tested the use of trolox as alternative standard for routine laboratory analysis, as it exhibits a similar behavior to oleuropein against  $\text{DMPD}^+$  formation. Trolox is usually used for measurements of antioxidant activity, however in this study we could prove satisfactory correlation with concentration results obtained from oleuropein calibration, so the phenol content could also be evaluate from calibration with trolox.

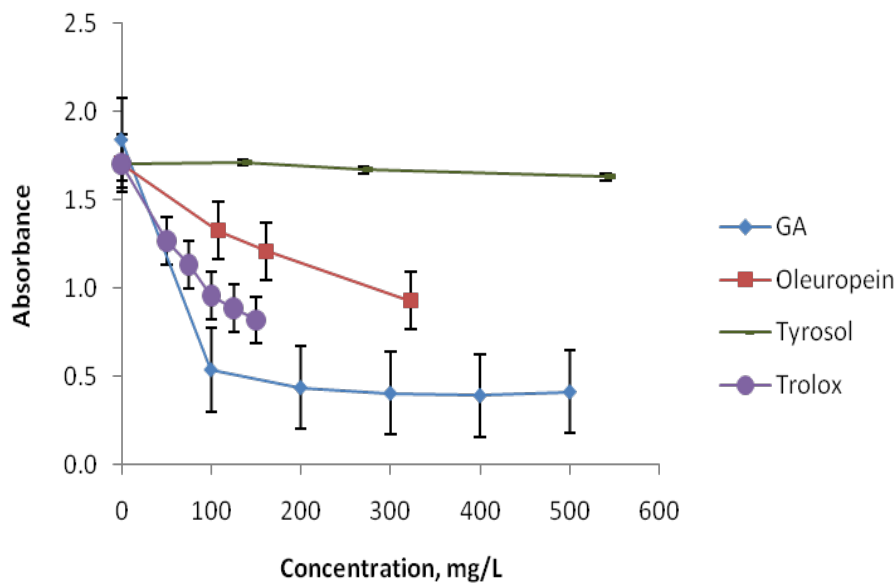

**Figure 6.** Inhibition curves of DMPD radical formation in presence of different antioxidants: gallic acid, tyrosol, oleuropein and trolox.

Calibration with trolox exhibited the equation  $y = 0.002x + 0.0634$  ( $r = 0.9936$ ;  $S_{y/x} = 0.035$ ;  $S_a = 0.046$ ;  $S_b = 0.00017$ ), where  $y$  = absolute value of absorbance decreasing and  $x$  = mg trolox/kg olive oil, respectively with a linear dynamic range from 125 to 375 mg trolox/kg olive oil. In this case, results from this calibration equation could easily be transformed in mg oleuropein/kg olive oil from the following correlation equation (Fig. 7):  $y = 1.783x - 16.046$  ( $r = 0.9665$ ;  $S_{y/x} = 12.3$ ;  $S_a = 48.4$ ;  $S_b = 0.18$ ), where  $y$  = mg oleuropein/kg olive oil, and  $x$  = mg trolox/kg olive oil.

To evaluate matrix effects, solvent calibration curves were prepared in 60% MeOH and matrix-matched calibration curves were prepared by spiking the appropriate volume of standard stock solution in refined olive oil extract (free of any antioxidant). Blank matrix standard, composed only by refined olive oil extract, did not show inhibition of DMPD radical formation and the same linear dynamic range was observed for solvent and matrix-matched calibration curves. The slope-ratio matrix/solvent for calibration curves, indicated that there were no matrix effects and therefore a solvent-based calibration curves could be used for quantitative purposes.

A repeatability study ( $n = 10$ ) at a concentration of 813 mg oleuropein/kg olive oil was carried out in order to evaluate the precision of the method. The relative standard deviation (RSD%) obtained was 2.5%. The LOD ( $3\sigma/m$ ) was estimated to be 7.8 mg oleuropein/kg olive oil and 4.4 mg trolox/kg olive oil, depending of the respective standard used.

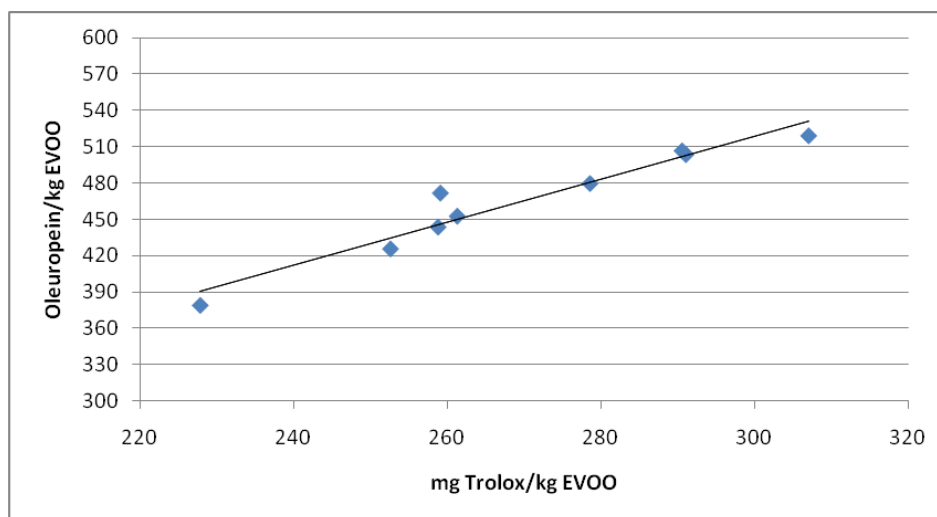

Figure 7. Correlation between sample analysis results using the two different standards proposed.

### 3.4. Analytical applications

Nine market-purchased EVOO samples were analyzed following the described general procedure. First, samples underwent a liquid-liquid extraction as above described, and subsequently they were injected in the multicommuted flow system for absorbance data acquisition. An example of three EVOO sample analysis is shown in Fig. 3. The total content of phenolic species is expressed as mg oleuropein/kg olive oil. In the studied samples it ranged from 378.8 mg/kg to about 519.4 mg/kg.

The Folin-Ciocalteu reaction [16] was used as reference method to determine the phenolic content in the studied samples in order to make a comparative evaluation of the results obtained with the proposed MCFIA method. As the proposed method uses a different standard (oleuropein) from that of Folin-Ciocalteu (gallic acid) used as refer-

ence method, the results are not expressed in the same units, so a t-test does not make sense in this case, but a correlation between the results from both methods. As can be seen in Fig. 8, the total phenolic contents obtained by F-C assay were consistent with results obtained by the developed method: correlation equation between FC/DMPD using oleuropein as reference standard for phenolic species was  $y = 0.9561x - 148.12$ , ( $r = 0.9706$ ;  $S_{y/x} = 11.4$ ;  $S_a = 41.8$ ;  $S_b = 0.090$ ). Therefore, the MCFIA procedure here proposed can be used as an alternative one to classic Folin-Ciocalteu method to estimate the total phenolic content in EVOO, with the well known advantages provided by MCFIA principle.

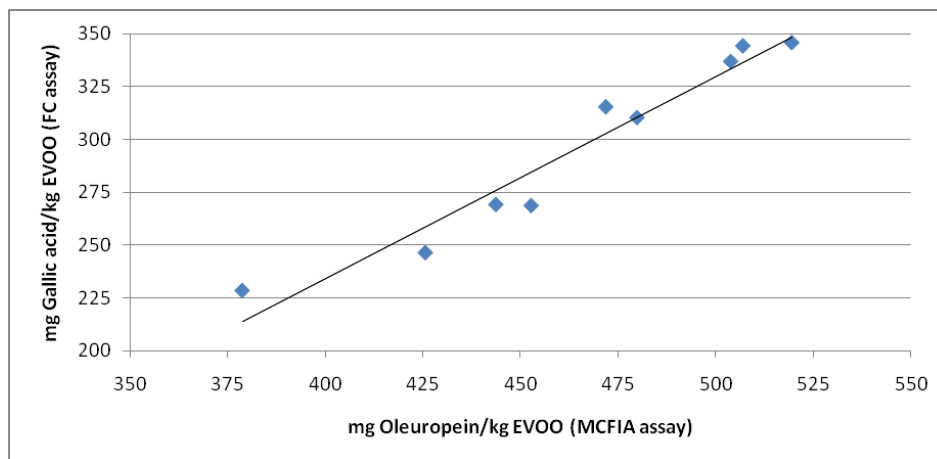

Figure 8. Correlation between the proposed method and Folin-Ciocalteu assay results.

A good correlation was also obtained with trolox between FC/DMPD, the equation was  $y = 0.5052x + 119.99$  ( $r = 0.9181$ ), where  $y$  = obtained value using trolox,  $x$  = obtained value with FC method, thus concluding that EVOO phenolic content can be estimated based on the DMPD<sup>+</sup> formation inhibition by EVOO methanolic extracts using trolox as standard for calibration.

Although the reagent is not specific and can respond to any antioxidants, not just to phenolic compounds, the contribution of additional species such as tocopherols is expected to be minor and practically negligible, in first place because they will be hardly extracted (it is assumed that 60% MeOH is able to extract those more polar antioxidant compounds, mainly phenolic ones, while other more hydrophobic (e.g. tocopherols)

remain in the oil matrix, so with DMPD only phenols are determined) and also because their concentration levels are significantly lower than those of phenolic species.

#### 4. Concluding remarks

In this work we proposed a MCFIA method based on the ability of natural olive oil antioxidants to inhibit DMPD radical formation in oxidant conditions. The use of oleuropein as standard is proposed to estimate the total phenolic content, while the versatile proposed method allows the use of trolox as alternatively cost-effective standard. This method has been applied to the determination of phenolic compounds in commercial EVOO samples. From the positive results obtained in this study, we can conclude that the proposed method is suitable to evaluate the total phenolic content in EVOO showing appropriate features to be implemented in routine analysis laboratories (higher suitability to be implemented in routine analysis laboratories than that exhibited by previous available automatic methods). It should be emphasized its attractive advantages over the traditional batch Folin-Ciocalteu method for phenols in VOO, such as higher sampling frequency, simplicity, automation and much lower sample and reagent consumption.

Compared to the MCFIA recently published by Nalewajko-Sieliwoniuk et al. [26] (based on a completely different principle), the sample preparation for the proposed method exhibits a significantly lower solvent consumption (8 mL against 54,5 mL) is also simpler to perform, quicker and cost effective and needs much lower sample amount than that used in ref. [26] (4 g against 15 g). Although the MCFIA from the latter exhibited a higher analysis rate (60 h<sup>-1</sup> throughput against 8 samples per hour in our method), it omitted the time required to perform sample preparation (SPE cartridge conditioning, sample loading, elution, extract evaporation and reconstitution and dilution), which is significantly longer than the approach we proposed, thus compensating the lower sampling rate of our procedure.

Regarding sensitivity (higher in the procedure by Nalewajko-Sieliwoniuk et al.) this analytical feature does not represent an issue when analysing phenolic compounds in olive oil, given their relatively high concentration levels. Finally, the RSD values exhibited for the olive oil analysed samples in ref [26] are higher than those shown by our procedure.

Further studies in order to explore the possibility of jointly measuring phenolic content and tocopherols in VOO by this procedure will be performed by using an appropriate extracting solvent [28], as well as studies on antioxidant activity of VOO in their respective conditions.

### Acknowledgments

The authors acknowledge funding support from the Regional Government of Andalusia (Spain), Junta de Andalucía (Project AGR-6066 and Research Group FQM323). F.J.L.-O. acknowledges a PhD student scholarship from MINECO (Ref. BES-2013-064014).

### References

- [1] F. Visioli, C. Galli, Olive Oil Phenols and Their Potential Effects on Human Health, *J. Agric. Food Chem.* 46 (1998) 4249.
- [2] M. Servili, R. Selvaggini, S. Esposito, A. Taticchi, G. Montedoro, G. Morozzi, Health and sensory properties of virgin olive oil hydrophilic phenols: agronomic and technological aspects of production that affect their occurrence in the oil, *J. Chromatogr. A* 1054 (2004) 113.
- [3] M. I. Covas, Bioactive effects of olive oil phenolic compounds in humans: reduction of heart disease factors and oxidative damage, *Inflammopharmacol.* 16 (2008) 216.
- [4] C.I.R. Gill, Y. Z. H.-Y. Hashim, M. Servili, I. Rowland, in: V.R. Preedy, R.R.; Watson (Eds.), *Olives and olive oil in health and disease prevention*, Academic Press: Oxford, U.K., 2010, pp. 1005.
- [5] H.K. Obied, P. Karuso, P. D. Prenzler, K. Robards, Novel secoiridoids with antioxidant activity from Australian olive mill waste, *J. Agric. Food Chem.* 55 (2007) 2848.
- [6] M. Carochi, I.C.F.R. Ferreira, *Food Chem Toxicol.* 51 (2013) 15.
- [7] I. Gülcin, *Arch. Toxicol.* 86 (2012) 345.
- [8] B. Bayram, T. Esatbeyoglu, N. Schulze, B. Ozcelik, J.Frank, G. Rimbach, *Plant. Foods Hum. Nutr.* 67 (2012) 326.
- [9] A. Carrasco-Pancorbo, L. Cerretani, A. Bendini, A. Segura-Carretero, M. Del Carlo, T. Gallina-Toschi, G. Lercker, D. Compagnone, A. Fernández-Gutierrez, *J. Agric. Food*

Chem. 53 (2005) 8918.

[10] S. Dabbou, F. Brahmi, A. Taamali, M. Issaoui, Y. Ouni, M. Braham, M. Zarrouk, M. Hammami, J. Am. Oil Chem. Soc. 87 (2010) 1199.

[11] C. Samaniego Sánchez, A.M. Troncoso González, M.C. García-Parrilla, J.J. Quesada Granados a, H. López García de la Serrana, M.C. López Martínez, Anal. Chim. Acta 593 (2007) 103.

[12] C. López-Alarcón, A. Denicola, Anal. Chim. Acta 763 (2013) 1.

[13] Hrnčirik, S. Fritsche, Eur. J. Lipid Sci. Technol. 106 (2004) 540.

[14] L.M. Magalhães, M.A. Segundo, S. Reis, J.L.F.C. Lima, Anal. Chim. Acta 613 (2008) 1.

[15] J. C. Sanchez-Rangel, J. Benavides, J. B. Heredia, L. Cisneros Zevallos, D. A. Jacobo-Velazquez, Anal. Methods 5 (2013) 5990.

[16] V.L. Singleton, J.A. Rossi, Am. J. Enol. Vitic. 16 (1965) 144.

[17] V.L. Singleton, R. Orthofer, R.M. Lamuela-Raventos, Method. Enzymol. 299 (1999) 152.

[18] L.M. Magalhães, M.A. Segundo, S. Reis, J.L.F.C. Lima, A. Rangel, J. Agric. Food Chem. 54 (2006) 5241.

[19] J.A. García-Mesa, M.D. Luque de Castro, M. Valcárcel, Anal. Chem. 63 (1993) 3540.

[20] M.P. Cañizares, M.T. Tena, M.D. Luque de Castro, Anal. Chim. Acta 323 (1996) 55.

[21] J. Ruiz-Jiménez, M.D. Luque de Castro, Anal. Chim. Acta 489 (2003) 1.

[22] V. Fogliano, V. Verde, G. Randazzo, A. Ritieni, J. Agric. Food Chem. 47 (1999) 1035.

[23] V. Papadimitriou, G. A. Maridakis, T. G. Sotiroudis, A. Xenakis, Eur. J. Lipid Sci. Technol. 107 (2005) 513.

[24] W. R. Melchert, B. F. Reis, F. R.P. Rocha, Anal. Chim. Acta 714 (2012) 8.

[25] A. Molina Díaz, J. F. García-Reyes, B. Gilbert-López, Trend Anal. Chem. 29 (2010) 654.

[26] E. Nalewajko-Sieliwoniuk, J. Malejko, A. Pawlukiewicz, A. Kojło, Food Anal. Methods, in press, DOI:10.1007/s12161-015-0274-8

[27] A. Vázquez-Roncero, C. Janer del Valle, M.L. Janer del Valle, Grasas y Aceites 22 (1973) 350.

[28] M. Tasioula-Margari, O. Okogeri, Food Chem. 74 (2001) 377.

## Artículo 2: Fast automated determination of total Tocopherol content in virgin olive oil using a single multicommuted luminescent flow method

### Resumen

La vitamina E es un término genérico utilizado para designar a un grupo de compuestos liposolubles presentes en los alimentos, a saber, tocoferoles y tocotrienoles, que ejercen actividad antioxidante. Los tocoferoles presentan como característica común un anillo cromanol, sustituido con grupos metilo y con una cadena lateral de tres isoprenos. Contribuyen a la notoria estabilidad del aceite de oliva virgen y son uno de los principales responsables de su actividad antioxidante y, en consecuencia, de su mayor resistencia a la oxidación en comparación con otros aceites vegetales. Los tocoferoles desempeñan un papel importante en la calidad y la autenticidad de del aceite de oliva virgen ya que pueden actuar como colectores de los radicales libres y prevenir la propagación de la peroxidación lipídica en alimentos y sistemas biológicos. Los tocoferoles son fluoróforos naturales de gran importancia para la caracterización y autenticación del aceite de oliva virgen.

En este artículo se ha desarrollado un sencillo método automático de análisis por inyección en flujo multicommutado (MCFIA) para la determinación del contenido total de tocoferoles en muestras de aceite de oliva virgen extra, así como para la estimación **semicuantitativa de  $\alpha$ -tocoferol**. El método tan sólo requiere la dilución apropiada de las muestras con 2-propanol para su análisis directo mediante inyección en un sistema de flujo multicommutado basado en el empleo de tres válvulas solenoide y detección fluorescente. Se utilizó como señal analítica la altura del pico registrado a  $\lambda_{em} = 330$  nm (emisión) con  $\lambda_{exc}$  a 296 nm.

La respuesta lineal se observó dentro del intervalo de 50 a 350 mg de tocoferoles (expresados como  $\alpha$ -tocoferol)  $kg^{-1}$  aceite), que resulta adecuado para cubrir el rango habitual de tocoferoles en aceite de oliva virgen extra. Los resultados de contenido total en tocoferoles no mostraron diferencia significativa con los obtenidos mediante el método de referencia basado en HPLC en fase inversa, mientras que el tiempo de análisis se



redujo significativamente: la velocidad de análisis del método automático propuesto es de unas 40 muestras h<sup>-1</sup>, en contraste con los 15-30 minutos requeridos por muestra mediante HPLC. En este estudio se observó que, debido a la significativamente mayor cantidad de  $\alpha$ -tocoferol respecto al resto de tocoferoles presentes en el aceite de oliva, se podría usar el contenido total estimado de tocoferoles como una aproximación al contenido de  $\alpha$ -tocoferol. El método es más respetuoso con el medio ambiente, rápido, directo, sencillo, económico y fácil de implementar en laboratorios de rutina para determinación semicuantitativa del contenido total de tocoferoles y  $\alpha$ -tocopherol, pudiendo ser usado como método de *screening*.



---

## Fast Automated Determination of Total Tocopherol Content in Virgin Olive Oil Using a Single Multicommuted Luminescent Flow Method

Felipe J. Lara-Ortega<sup>(a)</sup>, Bienvenida, Gilbert-López<sup>(b)</sup>, Juan F. García-Reyes<sup>(a)</sup> and Antonio Molina-Díaz<sup>(a,c)\*</sup>

<sup>a</sup>*Analytical Chemistry Research Group, Department of Physical and Analytical Chemistry, University of Jaén, E-23071 Jaén, Spain*

<sup>b</sup>*Foodomics Laboratory, Bioactivity and Food Analysis Department, Institute of Food Science Research - CIAL (UAM+CSIC), Campus de Cantoblanco, Calle Nicolás Cabrera 9, 28049 Madrid, Spain*

<sup>c</sup>*Center for Advanced Studies in Olives Grove and Olive Oils (CEAOAO), Science and Technology park GEOLIT, E-23620 Mengíbar, Spain*

**\* Corresponding author:**

Prof. Antonio Molina-Díaz, Analytical Chemistry Research Group, Department of Physical and Analytical Chemistry, University of Jaén, E-23071 Jaén, Spain; Tel.: (+34) 953212147; Fax: (+34) 953212940. E-mail: [amolina@ujaen.es](mailto:amolina@ujaen.es)

## Abstract

Tocopherols are natural fluorophores of great importance for the characterization and authentication of virgin olive oil. Herein, a single automatic multicommuted flow method has been developed for the determination of total tocopherol content as well as the semi-quantitative estimation of  $\alpha$ -tocopherol in extra virgin olive oil (EVOO) samples. Only appropriate dilution of samples with 2-propanol was necessary for their direct analysis by a multicommuted flow injection (MCFIA) manifold based on three solenoid valves with fluorescence detection. The peak height at  $\lambda_{em} = 330$  nm (emission) with  $\lambda_{exc}$  at 296 nm was used as analytical signal. Linear response was observed within the range from 50 to 350 mg of tocopherols (expressed as  $\alpha$ -tocopherol  $kg^{-1}$  olive oil), suitable to cover the usual range for tocopherols in (extra) virgin olive oil ((E)VOO)). The results were consistent with those obtained by reversed-phase HPLC reference method, whereas the analysis time was significantly reduced. The sample frequency of the proposed automatic method was close to 40 samples  $h^{-1}$ , in contrast to typically 15-30 min required by HPLC. The method is fast, straightforward, cost-effective and easy to implement in routine laboratories for screening purposes.

**Keywords:** Olive oil analysis;  $\alpha$ -Tocopherol estimation; Tocopherols determination; Flow injection analysis; Multicommutation.

## 1. Introduction

Vitamin E is a generic term used to designate a group of fat-soluble compounds present in food, namely tocopherols and tocotrienols, which exert antioxidant activity. Tocopherols (methyl-substituted chromanols with a three-isoprene moiety side chain), contribute to the outstanding stability of virgin olive oil (VOO) (Satue et al. 1995, Aparicio et al. 2013); they are one of the main responsible of its powerful antioxidant activity and consequently, of its higher resistance to oxidation compared to other vegetable oils (Boskou 2015). Tocopherols play an important role in quality and authenticity of VOO, since they can act as scavengers of free radicals and prevent the propagation of lipid peroxidation in food and biological systems. These antioxidant species are receiving great attention in different research areas (Sayago et al. 2007; García-González et al. 2008) as they contribute to human health through the prevention of cancer, cardiovascular and neurological diseases. Tocopherols and tocotrienols exist under their respective  $\alpha$ -,  $\beta$ -,  $\gamma$ - and  $\delta$ - species, which differ in the number and position of methyl groups on the chromanol ring (Figure 1). However, in the total tocopherol/tocotrienol profiles of VOO, usually about 94-96% of the total content is  $\alpha$ -tocopherol (Boskou, 1966; Cunha et al. 2006), the homologue that contains three methyl groups in the phenolic part of the cromane ring. The other tocopherols account for the 4-6% while tocotrienols are about 1% or less (even not detected) (Cunha et al. 2006). The content of  $\alpha$ -tocopherol in VOO ranges from about 90-100 mg kg<sup>-1</sup> to about 300-390 mg kg<sup>-1</sup>, approximately (Cunha et al. 2006; Schneider 2013; San Andrés et al. 2011; Sánchez-B et al. 2003; Psomiadou et al. 2000; Escuderos et al. 2009; Aparicio et al. 2013).

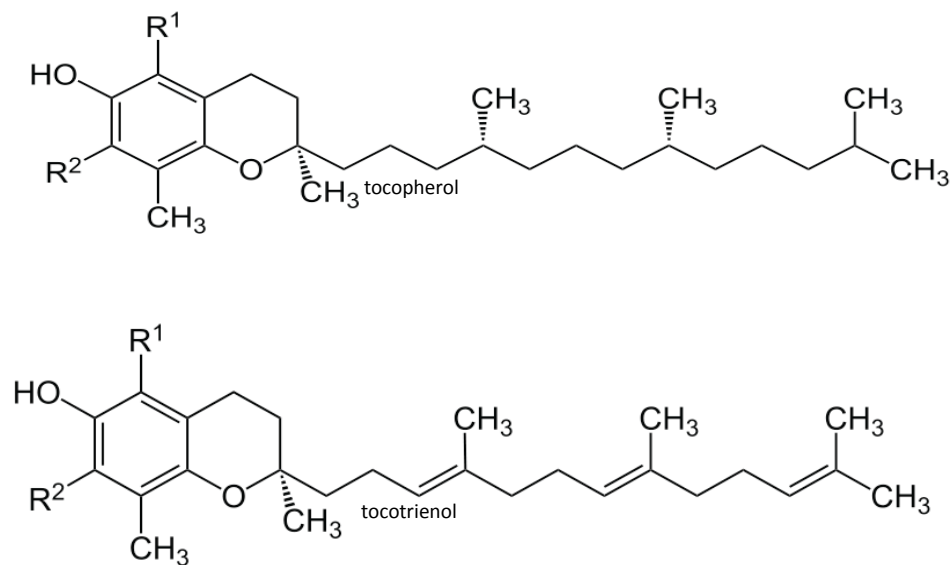

Species	R1	R2
α-Tocopherol/Trienol	CH3	CH3
β-Tocopherol/Trienol	CH3	H
γ-Tocopherol/Trienol	H	CH3
δ-Tocopherol/Trienol	H	H

Figure 1. Structure of the tocopherol and tocotrienol families.

The fluorescence emission spectra of olive oils provide information about their polyphenol and tocopherol content (Zandomeneghi et al. 2005; Giungato et al. 2004). Thus, fluorescence methods have been proposed not only for the evaluation of tocopherols content in VOO (Escuderos et al. 2009; Sikorska et al. 2005; Aparicio et al. 2013), but also for its characterization and the study of thermal and photo-oxidation (using total luminescence spectroscopy) (Sikorska et al. 2004). Fluorescence spectroscopy and

excitation-emission matrix fluorescence spectroscopy combined with multivariate analysis have been applied to olive oil studies including monitoring of oxidation (Cheikhousman et al. 2005), olive oil characterization (Guimet et al. 2005), detection of adulterations (Guimet et al. 2004) and evaluation of the overall quality (Guzmán et al. 2015). For direct estimation of tocopherol content, fluorescence measurements at 330 nm upon excitation at 290 nm have been recommended (IUPAC International Union of Pure and Applied Chemistry 1987). Other excitation and emission bands in VOO are associated to chlorophylls fluorescence and, in some cases, to other non ascertained fluorophores (Sikorska et al. 2004).

The most commonly applied methodologies described so far for tocopherols determination in VOO are based on either normal-phase or reverse phase HPLC modes using fluorescence detection (Cunha et al. 2006; Pinheiro-Sant'Ana et al. 2011; Zarrouk et al. 2009; Chen et al. 2001; Wong et al. 2014). Nevertheless, for the quantification and separation of  $\alpha$ -tocopherol from other tocopherols, reverse mode is preferred (Cho et al. 2007). Despite the reliability of HPLC methods, they may not be the most appropriate analytical method for a particular application. Therefore, the development of single, straightforward, faster and cost-effective procedures (preferably automatic ones) would be of interest to evaluate the total tocopherols content in VOOs.

In this sense, the use of fluorescence emission has been proposed to evaluate  $\alpha$ -tocopherol content in olive oil, finding relatively acceptable results (Escuderos et al. 2009). Nevertheless, they have to be improved, as they did not show appropriate linearity in some wavelengths of the selected spectra regions. Sikorska et al. (2005) used synchronous fluorescence spectroscopy with univariate and partial least-squares regression (PLS) to determine total tocopherol content, concluding that univariate regression originated relatively good results for diluted samples (1% v/v in n-hexane), but the univariate analysis failed for bulk samples due to the effect of matrix constituents, and PLS analysis had to be applied in this latter case. However, in both cases (emission or synchronous), the spectrum must be obtained for each sample, being, moreover, spectral data conveniently processed (stepwise linear regression analysis in the first case and PLS in the second one for bulk samples). Provided the need for high-throughput methods, these spectrofluorimetric procedures would not be the most suitable ones for

routine determination of  $\alpha$ -tocopherol and total tocopherol content for a high number of VOO samples. Therefore, the aim of this work was to develop a single automated flow method based on the use of multicommutation and fluorimetric measurements for the determination of total tocopherols content and semi-quantitative evaluation of  $\alpha$ -tocopherol from the native fluorescence of VOO (no derivatization step was necessary). The automatic developed procedure is straightforward, fast, and cost-effective, suitable for its implementation in routine laboratories for screening purposes.

## 2. Experimental

### 2.1 Reagents and Solutions.

All experiments were performed with analytical-reagent grade reagents.  $\alpha$ -Tocopherol standard, HPLC-grade 2-propanol (2-PrOH) (used as both solvent for sample and carrier solutions used in the flow system), methanol, acetonitrile (ACN), and tetrahydrofuran (THF) were purchased from Sigma-Aldrich (Madrid, Spain).

### 2.2 Oil Samples and $\alpha$ -Tocopherol Standard Preparation.

Twenty-one extra virgin olive oil (EVOO) samples were purchased from a local market. The samples were stored in the dark at  $20 \pm 3$  °C until measurements were performed. EVOO samples were vigorously shaken before weighing 400 mg of each one, being diluted with 2-PrOH up to 10 mL and vortex-mixed before analysis. No additional sample treatment was necessary. Stock and working solutions of  $\alpha$ -tocopherol were also prepared in 2-PrOH. The calibration curve was performed using an  $\alpha$ -tocopherol-free refined olive oil sample by adding the appropriate amount of a  $100 \text{ mg L}^{-1}$   $\alpha$ -tocopherol standard solution to obtain a concentration range from 5 to 15 mg  $\alpha$ -tocopherol  $\text{kg}^{-1}$  (Figure 2).

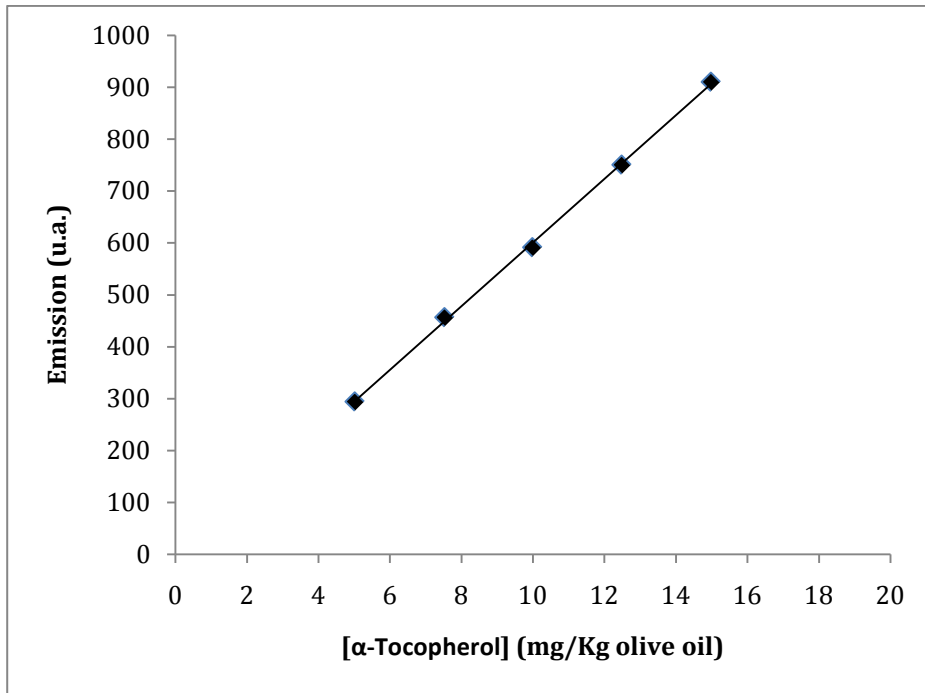

Figure 2. Calibration line ( $y = 61.339x - 12.333$ ,  $r = 0.9997$ ) for  $\alpha$ -tocopherol in EVOO by the proposed MCFIA method.

### 2.3 Proposed Fluorimetric Method

#### *Apparatus and Instruments.*

The fluorescence measurements were performed with a Cary-Eclipse Luminescence Spectrometer (Varian, Mulgrave, Australia) equipped with a xenon discharge lamp (75 kW), Czerny-Turner monochromators and a R-928 photomultiplier tube. The spectrofluorimeter was furnished with a Hellma 176.052-QS quartz flow-through cell (25  $\mu$ L internal volume and a 1.5-mm light-path length) (Jamaica, NY, USA). The spectrofluorimeter was connected to a computer with Cary Eclipse version 1.0 (Varian) software package for data collection and treatment.



*Instrument conditions.*

The determination of  $\alpha$ -tocopherol was performed using  $\lambda_{\text{ex}} = 296$  nm and  $\lambda_{\text{em}} = 330$  nm. Slit widths were 5 and 10 nm, respectively. The acquisition interval and the integration time were maintained at 1 nm and 0.5 s, respectively. The anode lamp voltage used was 800 V. The three-dimensional luminescence spectrum was acquired by measuring the emission spectra in the range from 320 to 400 nm, at excitation wavelengths from 280 to 310 nm, with 5-nm interval in the excitation domain.

*MCFIA network*

A scheme of the MCFIA network is depicted in Figure 3. A four-channel Gilson Miniplus-3 peristaltic pump (Villiers Le Bell, France) with flow rate selector and pump tubing type Watson Marlow (Wilmington, MA, USA) organic solvent resistance manifold tubing Grey/Grey (ID 1.29 mm) was used to propel solutions through the flow network. Three 161T031 NResearch three-way solenoid valves (NResearch, Northampton, UK) were employed to manage the flow pathway, making the solutions either to recirculate to their vessels or, alternatively driving them towards the detector. An electronic interface, based on ULN 2803 integrate circuit was used to control the valves, which were operated with an electric potential of 12V and a direct current of 100 mA. The homemade software for controlling the solenoid valves was written in Java. Teflon tubing (0.8 mm i.d.) and teflon fittings (Omnifit Ltd. Cambridge, UK) were used for merging solutions. The flow system used was a two-channel multicommutated manifold in which the oil sample was directly inserted (no derivative reaction was required). Its aim is only to transport the sample to the flow cell in the detector. The carrier (2-PrOH) is circulating through the switched off valves (position no. 0)  $V_1$  and  $V_3$  and sample is inserted by commuting  $V_1$  and  $V_2$  simultaneously (position no. 1).  $V_3$  is used to load the next sample after each measurement, leading the rest of the measured one to the waste.

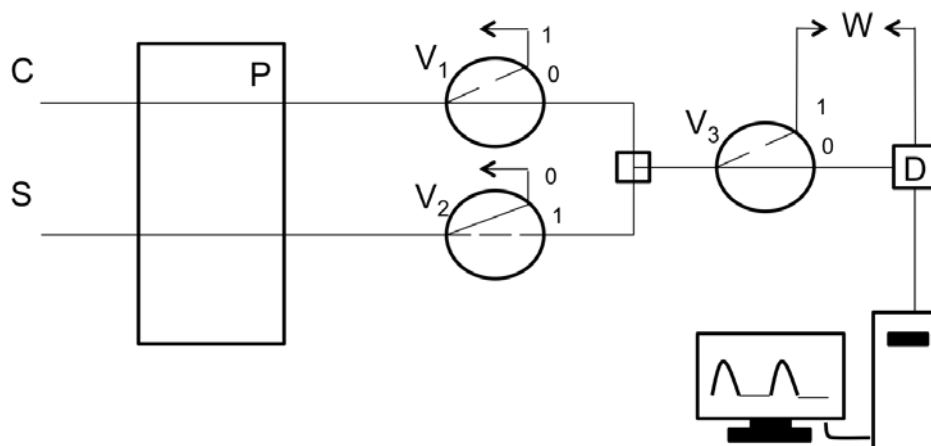

**Figure 3.** MCFIA network scheme. C, carrier. S sample. P, peristaltic pump. V, valves: position 0, non activated; position 1, activated. D, detector. W, waste.

#### General procedure.

Before recording the fluorescence peak signal, the new sample is loaded by switching on all the valves during 20s ( $V_3$  remains switched on during 10 additional seconds). Then, by simultaneously switching on  $V_1$  and  $V_2$  during 10 s, sample is introduced in the system while carrier is recirculated to its vessel. The transitory signal is recorded by circulating the carrier towards detector through  $V_1$  and  $V_3$  (both are switched off) during 1 min. 35 s. The valves switching sequence is summarized in Table 1.

**Table 1.** Valve operation scheme during the analytical process for three replicate injections

Description	V1	V2	V3	Analysis time
New sample loading (and old sample cleaning)	1	1	1	0 s
	0	0	1	20 s
First sample injection	1	1	0	30 s
	0	0	0	40 s
Second sample injection	1	1	0	2 min : 15 s
	0	0	0	2 min : 25 s
Third sample injection	1	1	0	4 min : 00 s
	0	0	0	4 min : 10 s

## 2.4 Reference method for determination of tocopherols

An HPLC method (Chen et al., 2011) was used as reference method to determine the total tocopherol content in the studied samples in order to make a comparative evaluation of the results obtained with the proposed MCFIA method. EVOO samples were weighted (about 40 mg) and made up to 10 mL with THF:ACN (40:60 v:v). In this method, no additional sample treatment is necessary and these vortex-mixed samples are directly injected onto HPLC column without filtration. Working  $\alpha$ -tocopherol standard solutions were also prepared in THF:ACN (40:60 v:v). Sample and standard solutions were prepared prior to the analysis. Tocopherols were quantified by reversed-phase high-performance liquid chromatography (RP-HPLC) using a Shimadzu Prominence series 20 HPLC system (equipped with a LC-20AD binary pump, DGU-20A5 vacuum degasser, SIL-20A8HT automatic injector and RF-20A fluorescence detector) (Shimadzu, Kyoto, Japan). Separations were carried out at room temperature ( $20 \pm 2$  °C) in a C18 Spherisorb ODS2 Column (80Å, 5  $\mu$ m, 4.6 mm X 250 mm) (Milford, MA, USA). The mobile phase was (isocratic mode) a mixture of THF:methanol 10:90 (v/v) at a flow rate of 1.0 mL min<sup>-1</sup>. Quantification was performed by fluorescence detector at  $\lambda_{ex}$  296 nm and  $\lambda_{em}$  330 nm. A typical chromatogram of an EVOO sample using the HPLC reference method is shown in Figure 4.

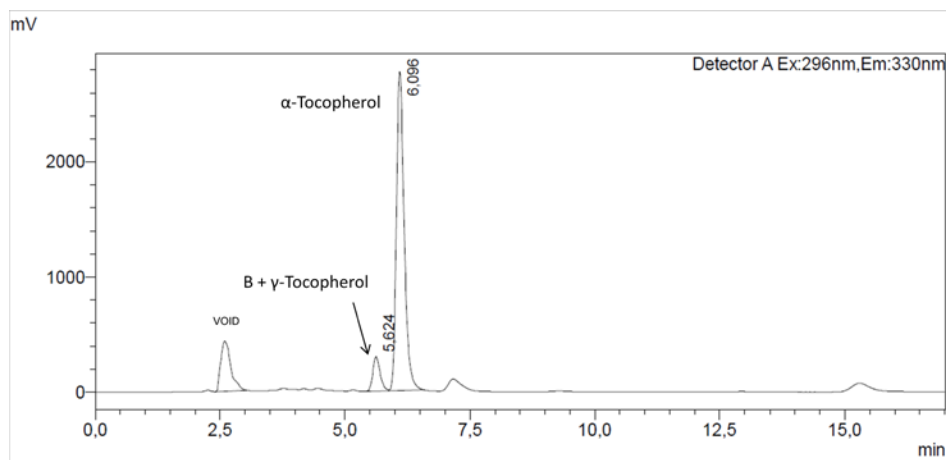

**Figure 4.** Typical tocopherol chromatogram of an EVOO sample using the HPLC reference method. For details see text.

### 3. Results and discussion

The native fluorescence of EVOO is - in a great extent-, due to their tocopherols content (Escuderos et al. 2009, Sikorska 2005) being  $\alpha$ -tocopherol found in much higher concentration than  $\beta$ - and  $\gamma$ -tocopherol (Boskou, 1966; Cunha 2006). Therefore, the concentration of these compounds can be estimated by measuring the native fluorescence signal of the EVOO sample with only a single previous dilution.

#### 3.1 Sample dilution

2-PrOH was used as solvent. Dilutions 1:10, 1:20 and 1:50 (w (g of EVOO):v (mL of 2-PrOH)) were tested being 1:20 finally selected. The first one was not able to solve the olive oil as two phases were observed and the 1:50 ratio showed worse signal/noise ratio and lower sensitivity than 1:20 dilution.

#### 3.2 Optimization of instrumental conditions

In order to optimize both the excitation and emission wavelength, the 3-D luminescence spectrum was acquired (Figure 5). The maximum luminescence signal was obtained at around  $\lambda_{ex} = 296$  nm with  $\lambda_{em} = 330$  nm, similar to those wavelength values associated with tocopherols by other authors (Sayago et al 2007; Escuderos et al. 2009), so these values were chosen for continuous signal monitoring.

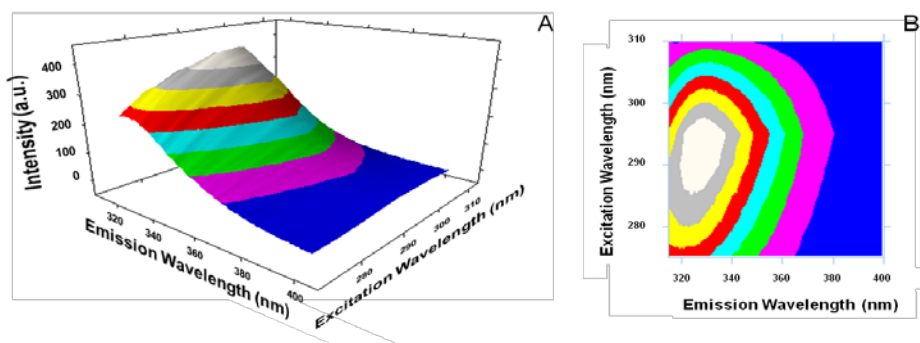

Figure 5. Three-dimensional total luminescence spectrum of EVOO in 2-PrOH. For details see text.

The detector voltage was evaluated from 600 to 1000V (maximum). The best signal-to-noise ratio was obtained using 800 V and 5 nm and 10 nm as excitation and emission slit widths, respectively.

### **3.3 Flow system variables**

The sample introduction time (by operating  $V_1$  and  $V_2$ ) and the flow-rate provided by the peristaltic pump were studied and optimized. The flow rate was investigated from 1.0 to 2.5 mL min<sup>-1</sup>. As expected, an increase of the flow rate produced an increase in both sampling frequency and the analytical signal due to increased sample volume in the same insertion time and the respective decrease of dispersion. A flow rate of 2.0 mL min<sup>-1</sup> was adopted as the optimum value as it provided both appropriate signal response and sampling rate with acceptable solvent consumption.

In the multicommutated flow network, the sample volume introduced in the system is controlled by means of changing the respective valve insertion time. The studied range for the introduction of sample was from 5 to 10 s. Finally 10 s were chosen, as a high sampling frequency (about 40 samples h<sup>-1</sup>) was obtained with satisfactory sensitivity. This is equivalent to an injection volume of 333 $\mu$ L. Considering the internal volume of the solenoid valve (27 $\mu$ L), the actual sample injection volume was (360  $\mu$ L). Figure 6 shows the typical profile of 10 injections of an EVOO sample.

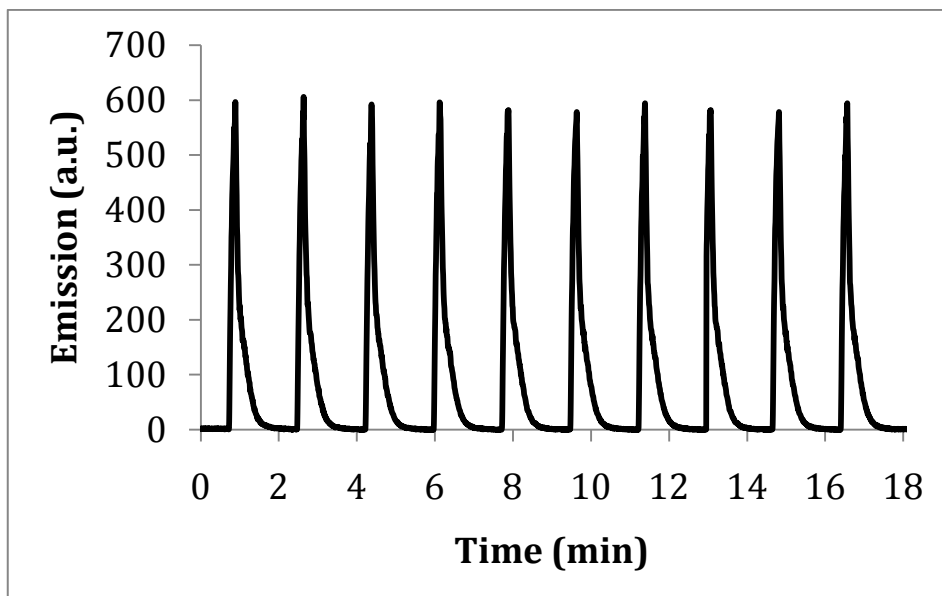
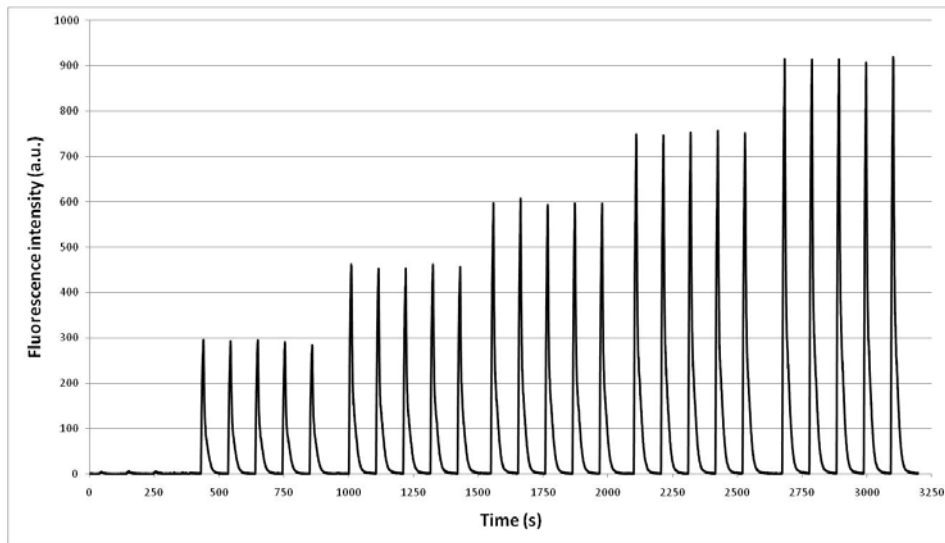

Figure 6. Typical profile of repeated measurements of emission signal for an EVOO sample injected 10 times.

### 3.4 Determination of $\alpha$ -tocopherol in EVOO samples.

Twenty-one market-purchased EVOO samples were analyzed following the described general procedure under optimized conditions. A calibration curve of  $\alpha$ -tocopherol was used for quantification purposes (Figure 2, diagram shown in Fig. 7a), getting a high reproducibility (RSD = 1.57%) in the analysis of ten replicate determination of an individual sample (Figure 6). The content of  $\alpha$ -tocopherol in the studied samples ranged from 87.4 mg kg<sup>-1</sup> to 325.6 mg kg<sup>-1</sup> (Tables 2 and 3), which is in accordance with usual values found by other authors (Cunha et al. 2006; Schneider 2013; San Andrés et al. 2011; Sánchez-B et al. 2003; Psomiadou et al. 2000; Escuderos et al. 2009; Aparicio et al. 2013). Figure 7b shows an example of diagram for the analysis of four different EVOO samples, each one of them injected by triplicate.

a)



b)

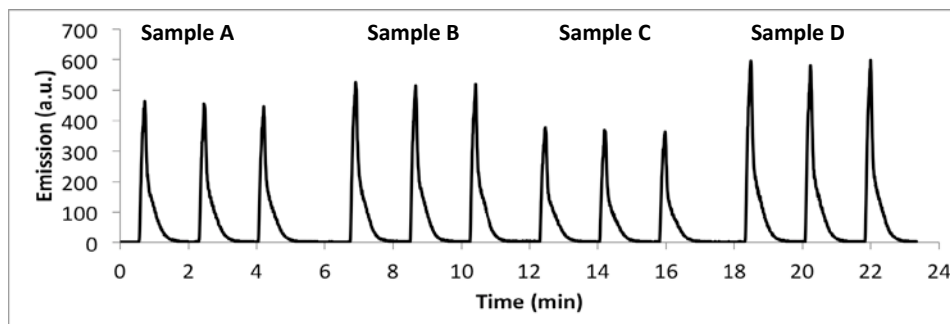

Figure 7. a) Profile diagram of calibration line. b) Typical signal profile corresponding to triplicate measures of four different EVOO samples.

On the other hand, the values obtained from the reference method range from 46.9 to 269.8. Although the two series of values show good linear correlation ( $r = 0.9370$ ), a significant difference between the mean values was observed, with the proposed method yielding higher values than the reference method (about a 28 % higher, see Table 2). Thus, the estimation of  $\alpha$ -tocopherol concentration could then indirectly be accomplished from the mean value of MCFIA/HPLC ratio observed.

**Table 2.** Results of  $\alpha$ -tocopherol ( $\text{mg kg}^{-1}$  EVOO) obtained from the analysis of 21 real EVOO samples by proposed MCFIA and HPLC procedures

Sample no.	MCFIA	HPLC	MCFIA/HPLC ratio
1	174.4	130.8	1.33
2	258.7	234.8	1.10
3	200.9	159.7	1.26
4	265.3	235.6	1.13
5	247.7	223.9	1.11
6	213.1	151.0	1.41
7	250.2	241.9	1.03
8	258.7	181.9	1.42
9	201.6	171.6	1.18
10	128.5	81.2	1.58
11	208.9	169.6	1.23
12	220.0	196.3	1.12
13	87.4	46.9	1.86
14	181.7	148.5	1.22
15	207.4	156.5	1.33
16	199.9	172.1	1.16
17	214.2	211.2	1.01
18	258.7	209.8	1.23
19	325.6	269.8	1.21
20	208.3	141.4	1.47
21	231.2	165.5	1.10
Mean <sup>a</sup>	216 $\pm$ 22	176 $\pm$ 24	1.28 $\pm$ 0.09
RSD (%)	23.2	30.1	15.6
$t_{\text{crit.}}$	2.09		
$t_{\text{exp.}}$	2.51		

Paired *t* test for the mean values<sup>a</sup>Results expressed as confidence intervals

However, when the total tocopherol content is estimated with the reference method (by adding the  $\beta$ - +  $\gamma$ -tocopherol areas to the  $\alpha$ -tocopherol one and assuming that the total area correspond to  $\alpha$ -tocopherol), the mean values from the two methods are coincident (Table 3) and also show good linear correlation ( $r = 0.9419$ ). This fact indicates that the developed procedure actually enable the measurement of the total content of tocophe-



rols expressed as  $\alpha$ -tocopherol in EVOO and that, moreover, the contribution of  $\beta$ - and  $\gamma$ -tocopherol is much smaller than that of  $\alpha$ -tocopherol, as previously described (Cunha et al. 2006).

Table 3. Results obtained (mg kg<sup>-1</sup> EVOO) from the analysis of 21 real EVOO samples by proposed MCFIA procedure and HPLC (total tocopherol content) reference procedure

Sample no.	MCFIA	HPLC	MCFIA/HPLC ratio
1	174.4	178.5	0.98
2	258.7	307.2	0.84
3	200.9	205.4	0.98
4	265.3	296.6	0.89
5	247.7	261.4	0.95
6	213.1	184.5	1.15
7	250.2	266.8	0.94
8	258.7	227.5	1.14
9	201.6	203.5	0.99
10	128.5	110.9	1.16
11	208.9	219.0	0.95
12	220.0	232.6	0.95
13	87.4	75.4	1.16
14	181.7	180.3	1.01
15	207.4	200.8	1.03
16	199.9	211.1	0.95
17	214.2	214.2	1.00
18	258.7	267.6	0.97
19	325.6	312.1	1.04
20	208.3	177.9	1.17
21	231.2	194.9	1.19
Mean <sup>a</sup>	216 ± 22	216 ± 26	1.02 ± 0.05
RSD (%)	23.2	29.9	
t <sub>crit.</sub>	2.09		
t <sub>exp.</sub>	0.041		

Paired *t* test for the mean values

<sup>a</sup>Results expressed as confidence intervals

From the results obtained, it can be concluded that the automated method developed is suitable for the quick estimation of total tocopherol content in commercial EVOO samples, offering attractive convenient to be implemented in routine analysis laboratories. Moreover, it features interesting advantages compared to HPLC reference method, such as its simplicity, cost-effectiveness and high-throughput.

#### 4. Concluding remarks

Herein, a MCFIA method has been developed for the determination of total tocopherol content in commercial extra VOO samples, based on the native fluorescence featured by tocopherols. The usefulness of the proposed method has been assessed by means of the analysis of several EVOO samples. The results showed no significant difference with those from the HPLC reference method, with the attractive advantages of being simple, faster and more cost-effective. Furthermore, it can be easily implemented in routine analysis laboratories. Additionally, semi-quantitative evaluation of  $\alpha$ -tocopherol can be provided by the proposed fluorimetric method.

**Acknowledgments.** The authors acknowledge funding support from the Regional Government of Andalusia (Spain), Junta de Andalucía (Project AGR-6066 and Research Group FQM323). F.J.L.-O. acknowledges a PhD student scholarship from MINECO (Ref. BES-2013-064014). B.G.L. acknowledges MINECO for her *Juan de la Cierva* post-doctoral research contract (ref. JCI-2012-12972).

#### Compliance with Ethical Standards

**Conflict of Interest** Felipe J. Lara-Ortega declares that he has no conflict of interest. Bienvenida Gilbert-López declares that she has no conflict of interest. Juan F. García-Reyes declares that he has no conflict of interest. Antonio Molina-Díaz declares that he has no conflict of interest.

**Ethical Approval** This article does not contain any studies with human participants or animals performed by any of the authors.

**Informed Consent** Not applicable.

## References

Aparicio R, Harwood J (Editors) (2013) Handbook of Olive Oil. Analysis and Properties. 2nd Ed. Springer New York

D Boskou (Ed) Olive oil chemistry and technology. AOCS Press, Champaign, IL (1996)

Boskou D (Editor) (2015) Olive Oil. In olive Chemistry and Technology. 2nd Ed. AOCS Press

Cheikhousman R, Zude M, Bouveresse DJR, Léger CL, Rutledge DN Birlouez-Aragon (2005) Fluorescence spectroscopy for monitoring deterioration of extra virgin olive oil during heating. *Anal Bioanal Chem* 382: 1438–1443

Chen H; Angiulli M; Ferrari C; Tombari E ;Salvetti G; Bramanti E (2011) Tocopherol speciation as first screening for the assessment of extra virgin olive oil quality by reversed-phase high-performance liquid chromatography/fluorescence detector. *Food Chem* 125:1423-1429

Cho IK, Rima J, Chang CL, Li, QX (2007) Spectrofluorometric and high performance liquid chromatographic determination of all-rac- $\alpha$ -tocopheryl acetate in virgin olive oil. *J Food Comp Anal* 20: 57-62

Cunha SC, Amaral JS, Fernandes JO, Oliveira, MBPP (2006) Quantification of tocopherols and tocotrienols in Portuguese olive oil using HPLC with three different detection systems. *J Agric Food Chem* 54:3351-3356

Escuderos ME, Sayago A, Morales MT, Aparicio R (2009) Evaluation of  $\alpha$ -tocopherol in virgin olive oil by a luminiscent method. *Grasas y aceites* 60: 336-342

García-González DL; Aparicio-Ruiz R; Aparicio R (2008) Olive oil. In Kamal-Eldin A, Moreau R. (Eds.) *Gourmet and Health-Promoting Oils*. AOCS Press, Champaign IL 1-40

Giungato P, Aveni M, Rana R, Notarnicola L (2004) Modifications induced by extra virgin olive oil frying processes. *Ind Aliment-Italy* 43:369–375

Guimet F, Ferré J, Boqué R, Rius FX. (2004) Application of unfold principal component analysis and parallel factor analysis to the exploratory analysis of olive oils by means of excitation–emission matrix fluorescence spectroscopy. *Anal Chim Acta* 515:75–85

Guimet F, Ferré J, Boqué R, Vidal M, García J (2005) Excitation-emission fluorescence spectroscopy combined with three-way methods of analysis as a complementary technique for olive oil characterization. *J Agric Food Chem* 53: 9319-9328

Guzmán E, Baeten V , Fernández Pierna JA García-Mesa JA (2015) Evaluation of the overall quality of olive oil using fluorescence spectroscopy. *Food Chem* 173:927-934

IUPAC International Union of Pure and Applied Chemistry (1987) Method 2.432, determination of tocopherols and tocotrienols in vegetable oils and fats by HPLC. In: Paquot C, Haufenne A (Eds) *Standard methods for the analysis of oils, fats and derivatives*, 7th edn. Blackwell Scientific Publications. Oxford, UK, pp 2432/1–2432/7

Pinheiro-Sant'Ana HM, Guinazi M, Oliveira DdS, Della Lucia CM, Reis BDL, Brandão SCC (2011) Method for simultaneous analysis of eight vitamin E isomers in various foods by high performance liquid chromatography and fluorescence detection. *J Chromatogr A* 1218:8496-8502

Psomiadou E, Tsimidou M, Boskou D (2000)  $\alpha$ -Tocopherol content of Greek virgin olive oils *J Agric Food Chem* 48:1770-1775

San Andrés MP, Otero J, Vera S (2011) High performance liquid chromatography method for the simultaneous determination of  $\alpha$ -,  $\gamma$ - and  $\delta$ -tocopherol in vegetable oils in

presence of hexadecyltrimethylammonium bromide/n-propanhol in mobile phase. Food Chem 126:147-1474

Sánchez-B PL, Camacho-L M, Aparicio, R (2003) A Comprehensive study of hazelnut oil composition with comparison to other vegetable oils, particularly olive oil. Eur Food Res Technol 218:13-19

Satue MT, Huang SW, Frankel EN (1995) Effects of natural antioxidants in virgin olive oil on oxidative stability of refined, bleached, and deodorized olive oil. J Am Oil Chem Soc 72: 1131–1137

Sayago A; Marín MI; Aparicio R; Morales MT (2007) Vitamin E and vegetable oils. Grasas y Aceites. 58:74-86

Schneider (2013) Quality analysis of virgin olive oils. Part 4. Application note. <https://www.agilent.com/cs/library/applications/5991-2180EN.pdf>

Sikorska E, Romaniuk A., Khmelinskii IV, Herance R, Bourdelande JL Sikorski M, Koziol J (2004) Characterization of Edible Oils Using Total Luminescence Spectroscopy. J Fluor. 14: 25-35

Sikorska E, Gliszczyń-Świgło A, Khmelinskii IV, Sikorski M (2005) Synchronous fluorescence spectroscopy of edible vegetable oils. Quantification of Tocopherols. J Agric Food Chem 53:6988-6994

Wong YF, Makahleh A, Saad B, Ibrahim MNM, Rahim AA, Brosse N (2014) UPLC method for the determination of vitamin E homologues and derivatives in vegetable oils, margarines and supplement capsules using pentafluorophenyl column. Talanta 130:299-306

Zandomeneghi M, Carbonaro L, Caffarata C (2005) Fluorescence of Vegetable Oils: Olive Oils. J Agric Food Chem 53: 759-766

Zarrouk W, Carrasco-Pancorbo A, Zarrouk M, Segura-Carretero A, Fernández-Gutiérrez A (2009) Multi-component analysis (sterols, tocopherols and triterpenic dialcohols) of the unsaponifiable fraction of vegetable oils by liquid chromatography-atmospheric pressure chemical ionization-ion trap mass spectrometry. *Talanta* 80: 924-934



### Artículo 3: Multicommutated flow injection analysis using chemiluminescence detection (MCFIA-CL) for olive oil analysis

#### Resumen

En el último artículo de esta tesis sobre métodos de análisis por inyección en flujo multiconmutados (MCFIA) se describe el desarrollo y validación de dos métodos quimioluminiscentes (CL). El primer método propuesto, que tan sólo usa dos válvulas solenoide de tres vías, permite la determinación del índice de peróxidos (IP, que es un parámetro de calidad del aceite), basado en la señal CL producida en medio básico por la reacción del luminol con los hidroperóxidos procedentes de la oxidación de acilglicéridos y ácidos grasos, catalizada por Co (II) y usando 1-propanol como disolvente de la muestra de aceite (se trabaja así en una solución monofásica). El método permite la determinación del índice de peróxidos en el intervalo establecido según los requerimientos de la normativa. Frente al método oficial, basado en una valoración redox, destaca su rapidez, comodidad, precisión y respeto medioambiental, siendo el primer método automático descrito para la determinación del índice de peróxidos basado en medidas quimioluminiscentes.

En el segundo método multiconmutado propuesto se determina el contenido de compuestos fenólicos/antioxidantes basándose en la medida directa de la señal quimioluminiscente emitida en la reacción de oxidación de estas especies en medio ácido por el permanganato potásico, usando tiosulfato como exaltador de la señal. El método permite analizar 180 muestras (extractos)/hora (proporcionando una mayor velocidad de análisis que la del método fotométrico desarrollado en el artículo 1) y es el primer método automático descrito para determinación de fenoles/antioxidantes en aceite de oliva virgen por quimioluminiscencia directa. Como en el anterior método, se trabaja con el extracto hidroalcohólico de la muestra, insertándose una alícuota del mismo en el sistema multiconmutado, que emplea tres válvulas solenoide de tres vías.

En ambos métodos el control de las válvulas del sistema multiconmutado para el control de los distintos canales de muestra y reactivo se realiza mediante una interfaz electrónica y un software escrito en Java, ambos de fabricación propia. El detector de



quimioluminiscencia fue también de construcción propia a partir de un tubo fotomultiplicador de la firma Hamamatsu. Las señales obtenidas correlacionaron bien, por un lado con los respectivos valores del IP (obtenidos por el método oficial) y, por otro lado, con los respectivos contenidos de compuestos fenólicos totales (obtenidos por el método de FC) que estaban dentro del intervalo de concentración en el que es común hallar estos últimos en aceites de oliva virgen. Los métodos propuestos son más rápidos, seguros y respetuosos con el medio ambiente que los del método oficial (IP) o convencional (fenoles), lo que implica un menor consumo de disolventes, de reactivos y de volumen de muestra y una menor generación de residuos, con una alta frecuencia de muestreo. Estas características los hacen apropiados para análisis de rutina y pueden ser consideradas como una alternativa factible, respectivamente, a la metodología oficial y convencional.

## Multicommuted flow injection analysis using chemiluminescence detection (MCFIA-CL) for olive oil analysis

(Submitted to Food Analytical Methods)

Felipe J. Lara-Ortega<sup>1\*</sup>, Bienvenida Gilbert López<sup>1,2\*</sup>, Miriam Beneito Cambra<sup>1</sup>, Antonio Molina-Díaz<sup>1,2\*\*</sup>

<sup>1</sup>*Analytical Chemistry Research Group, Department of Physical and Analytical Chemistry, University of Jaén, Campus Las Lagunillas, Edif. B-3, 23071 Jaén, Spain*

<sup>2</sup>*Center for Advanced Studies in Olives Grove and Olive Oils (CEAOAO), Science and Technology Park GEOLIT, E-23620 Mengíbar, Spain*

\*These authors contributed equally to this work.

\*\*Corresponding author: Prof. Antonio Molina-Díaz. Analytical Chemistry Research Group, University of Jaén, 23071 Jaén, Spain. Tel.: (+34) 953 212147; Fax: (+34) 953 212940. E-mail: [amolina@ujaen.es](mailto:amolina@ujaen.es)

## **Abstract**

This article describes the applicability of multicommutated chemiluminescence flow injection analysis (MCFIA) to the determination of olive oil quality parameters. Two automated MCFIA methods were developed and validated for the determination of peroxide value (PV) and phenolic compounds in commercial extra virgin olive oil samples. The PV method proposed is based on the chemiluminescence (CL) signal produced by luminol and the olive oil hydroperoxides in basic conditions using Co(II) as catalyst (indirect CL determination), while the determination of phenolic compounds is based on the direct permanganate CL emission from the aqueous extracts of olive oil. The flow assemblies for automated liquid handling consisted, respectively, of 2 and 3 three-way solenoid valves, which were controlled by a homemade electronic interface and Java-written software together with a CL detector. The signals obtained correlated well against the PV and total phenolic contents measured by the official and the Folin-Ciocalteu methods, respectively. The linear response range observed for PV allows to check whether the samples are in compliance with European Union regulations. On the other hand, the phenolic compounds content also correlated well with data reported by the well-known FC method across the entire typical concentration range of these compounds in virgin olive oils. The proposed methods are faster, safer and more environmentally friendly than the respective official or classical ones involving lower consumption of solvents, reagents and sample, as well as less waste generation together with a high sample throughput. Moreover, they are straightforward and cost-effective to implement in routine analysis, and can be regarded as a feasible alternative to the official or classic methods.

**Keywords:** peroxide value; phenolic compounds; olive oil; flow injection analysis; chemiluminescence; multicommutation.

## 1. Introduction

Virgin olive oil (VOO) is a well demonstrated source of health, especially for its cardiovascular benefits and its antioxidant power (Ross 2013; Schwingshackl and Hoffmann 2014) and one of the pillar of the traditional Mediterranean diet. The unique features of its composition are the reason of its higher resistance to oxidation, which is due to the natural presence of antioxidants that delay the oxidation of lipids and the production of the undesirable volatile compounds (Gutiérrez and Fernández 2002), being the phenolic compounds the main responsables of VOO antioxidant capacity. This feature provides added value to the commodity, thus becoming also central in the economy, culture, gastronomy and people's life from producing countries like Spain. A wide range of phenolic compounds have been identified in VOO, including phenolic alcohols, phenolic acids, lignans, flavonoids and secoiridoid derivatives. The particular composition of the phenolic fraction depends heavily on factors such as the actual cultivar, climatic conditions during growth, degree of maturation, or the olive mill technology used for oil extraction (Artajo et al. 2007).

Unfortunately, flavour, aroma, the nutritional value and, consequently the price, are affected by different factors, being olive oil lipid oxidation one of the more critical ones. Lipid oxidation is the main process that leads to quality deterioration, degradation and off flavour formation in edible fats like olive oil and causes health risks. The formation of lipid hydroperoxides is the first of two stages of a complex process that occurs in edible fats (Yu et al. 2007), also related to storage conditions after production (oxygen, light exposure and temperature) (Grossi et al. 2015) and can be used as initial oxidation state indicator. On the other hand, phenolic compounds are amongst the molecules with the highest capacity to block free radicals, thus acting as primary antioxidants by donating a radical hydrogen to radicals formed during the first step of lipids oxidation, thus, originating a stable compound. Therefore, the determination of both peroxide and phenolic compounds content has a great interest in order to characterize a VOO.

The common index to estimate lipid peroxidation in olive oils is the peroxide value (PV). In the European regulation (European Commission 1991), PV is defined as "*the quantity of those substances in the sample, expressed in terms of milliequivalents of active oxy-*

gen per kilogram, which oxidize potassium iodide under the operating conditions described in the official method. This official method is based on the classic titration of iodine liberated from potassium iodide by peroxides present in the olive oil; it is an empirical time-consuming procedure, which requires large volumes of organic solvents, and being human factor a very important source of errors. On the other hand, phenolic compounds are usually estimated as a whole and their total content expressed under the form of a representative member of the group, *i.e.* caffeic or gallic acids. The most used procedure for determination of phenolic compounds in olive oil is probably the Folin-Ciocalteu (FC) method, based on the reducing action of these compounds on the FC reagent in basic medium (Hrncirik and Fritsche 2004). Different approaches methods have been proposed for the determination of PV in edible oils either in batch mode or as an automated method, including UV-visible spectrophotometry (Dhaouadi et al. 2006; Talpur et al. 2010, Tian and Dasgupta 1999, Wang et al. 2016), fluorescence (Akasaka et al. 1996; Chotimarkorn et al. 2005; Sohn et al. 2005), infrared spectroscopy (Armenta et al. 2007; Yu et al. 2007) and chemiluminescence (CL) (Bunting and Gray 2003; Stepanyan et al. 2005; Bezzi et al. 2008; Tsiaka et al. 2013) together electroanalytical (Saad et al. 2006) and chromatographic methods (Steenhorst-Slikkerveer et al. 2000). On the other hand, methods for total phenolic index (as well as the antioxidant activity and phenolic fractions) in olive oil have been described based on different analytical techniques (Papadopoulos et al. 2003; Hrncirik and Fritsche 2004; Carrasco-Pancorbo et al. 2005; Christodouleas et al. 2009; Christodouleas et al. 2014) in both batch and automatic modes. Recently, a critical review on estimation of the total content of phenolic compounds in food matrices (including vegetable oils) has been published (Granato et al. 2016).

Automatic flow procedures are highly desirable for routine analysis, as they require lesser human intervention, and usually exhibit higher sample throughput than batch methods and better analytical features. Automatic flow injection procedures have been described to measure PV in olive oil based on UV-visible spectrophotometry (Tian and Dasgupta 1999; Nourou et al. 1999; Dhaouadi et al. 2006), fluorescence (Akasaka et al. 1996; Sohn et al. 2005) and potentiometric (Saad et al. 2006) detection. Some of them use complicated flow manifold or need heating reactors and use toxic organic solvent, so they are not environmentally friendly. The total phenolic index of olive oils have been also

measured based on the use of automatic flow injection systems (Lara-Ortega et al. 2016; Michalowski et al 2000, Nalewajko-Sieliwoniuk et al. 2016).

CL detection has been described to determine PV in olive oils by batch procedures (Bunting and Gray 2003; Stepanyan et al. 2005; Bezzi et al. 2008; Rolewski et al. 2009; Tsiaka et al. 2013). However, no automatic CL methods have been described for PV measurement in olive oils. Fast, cheap, simple, specific, high detection sensitivity and easy to automate are a series of advantages showed by an automatic chemiluminescent approach, which could be implemented in factories for on-line quality control. However, only a flow injection CL method has been developed for lipid hydroperoxides quantification in vegetable oils different from olive oil (namely: corn, cottonseed, peanut, soybeans and wheat germ oils) (Bunting and Gray 2003).

With regards to the total phenolic content determination in olive oils, CL detection in batch mode has been described based on the use of the well-known lucigenine-H<sub>2</sub>O<sub>2</sub> reaction (Nikokavoura et al. 2011). Only one procedure has been described for automatic flow CL determination of total phenol index in food samples (including two olive oil samples) which is based on the enhancing effect of phenolic compounds on CL of the Mn(IV)-formaldehyde-hexametaphosphate system (Nalewajko-Sieliwoniuk et al. 2016). However, no direct (oxidation) CL has been studied for determination of total phenol index in olive oil. On the other hand, most organic compounds which produce direct CL emission with acid permanganate contain a phenolic or amine moiety (Adcock et al. 2007). Therefore, the phenolic compounds present in fruits and their processed foods could be expected to generate CL when reacting with permanganate in acidic medium. In fact, automatic CL determination of phenol in waters based in this reaction has been described (Michalowski et al. 2000). In this sense, in a previous publication (Costin et al. 2003), the total phenolic index/antioxidants levels in wine were monitorized in a flow-based system by means permanganate CL detection.

In this article, the automatic CL determinations of both PV and total phenol index of commercial VOO are described. The approaches are based on the use of a multicommutated flow injection analysis (MCFIA) system assembly. PV determination is based on the CL signal produced by luminol and the olive oil hydroperoxides in basic conditions

using Co(II) as catalyst and no previous treatment other than sample dilution. In order to work in a homogeneous non-aqueous reaction bulk, in this study 1-Propanol was used (as already described in other papers). This solvent is environmental friendly and non-hazardous, so, the hazards of previously developed procedures (including those ones using chloroform, as the official one) is avoided. On the other hand, total phenol/antioxidant content determination is based on direct permanganate CL emission in acidic medium from the aqueous extracts of olive oil, using thiosulfate to enhance the CL signal.

## 2. Experimental section

### 2.1. Reagents and solutions

All experiments were performed with analytical grade reagents. Methanol, 1-Propanol (1-PrOH), sodium hydroxide (NaOH), Cobalt (II) chloride hexahydrate ( $\text{CoCl}_2 \cdot 6\text{H}_2\text{O}$ ), Ethylenediaminetetraacetic acid disodium salt dihydrate (EDTA) ( $\text{C}_{10}\text{H}_{14}\text{N}_2\text{Na}_2\text{O}_8 \cdot 2\text{H}_2\text{O}$ ), sulfuric acid, potassium permanganate and sodium thiosulphate pentahydrate ( $\text{Na}_2\text{S}_2\text{O}_3 \cdot 5\text{H}_2\text{O}$ ) were supplied by Panreac (Barcelona, Spain). Hemin, chloroform and potassium iodide (KI) were purchased from Sigma-Aldrich (Madrid, Spain). Starch was purchased from Fluka and **3-aminophthalhydrazide** (luminol,  $\text{C}_8\text{H}_7\text{N}_3\text{O}_2$ ) from Biochemika. A Milli-Q-Plus ultra-pure water system from Millipore (Milford, MA, USA) was used throughout the study to obtain highly pure water for the preparation of NaOH solution

**NaOH solution.** Stock solution of  $40 \text{ g L}^{-1}$  from NaOH pellets was prepared with Milli-Q water. **Co (II) solution.** Working solution of  $0.10 \text{ g L}^{-1}$  from  $\text{CoCl}_2 \cdot 6 \text{ H}_2\text{O}$  was freshly prepared with 1-PrOH. Different dilutions were prepared in 1-PrOH, up to  $0.025 \text{ g L}^{-1}$ .

**Co(II)-EDTA solutions.**  $0.0500 \text{ g}$  of EDTA and  $0.0100 \text{ g}$  of  $\text{CoCl}_2 \cdot 6\text{H}_2\text{O}$  were dissolved with  $100 \text{ mL}$  of 1-PrOH. Several dilutions were prepared in 1-PrOH for optimization purposes.

**Hemin solution.**  $0.0375 \text{ g}$  of hemin were dissolved in 1-PrOH to a final volume of  $250 \text{ mL}$ .

**Luminol solution.** Stock solution of 10 g L<sup>-1</sup> from luminol was prepared in the NaOH solution of 40 g L<sup>-1</sup>. Working solutions of 1 g L<sup>-1</sup> luminol were prepared by diluting with 1-PrOH.

KMnO<sub>4</sub>, Na<sub>2</sub>S<sub>2</sub>O<sub>3</sub> and H<sub>2</sub>SO<sub>4</sub> solutions were prepared in Milli-Q water.

## **2.2. Olive oil samples and sample treatment**

### **2.2.1. For PV determination**

Eight Extra Virgin Olive Oil (EVOO) samples and one olive oil sample (which is a mix composed by virgin olive oil (VOO) and refined olive oil (ROO)), were purchased in local markets. In addition, one of the EVOO samples was oxidized in order to increase the PV range to be explored with the developed procedure. For this purpose, 200 mL of this sample were heated up to 180°C with magnetic stirring (at 1500 rpm) for three hours, taking an aliquot of about 15 mL each hour. Therefore, the study was performed on a total of 12 samples.

The sample treatment was simple, about 1.500 g of oil sample were weighted in a 10-mL volumetric flask and made up to the mark with 1-Propanol.

### **2.2.2. For phenolic compounds determination**

Fourteen EVOO samples purchased in local markets were used in this study. Two different sample treatments were assayed to extract the phenolic compound from the oil samples based on:

a) Solid phase extraction. Diol SPE cartridges (1 g, 6 mL) were conditioned by passing through them 10 mL of MeOH and 10 mL of hexane. Then, 1.000 g of oil sample dissolved in 10 mL of hexane was loaded, next the cartridge was washed with 10 mL of hexane plus 10 mL of hexane/ethyl acetate (90:10 v/v). Finally, it was dried under vacuum and eluted with 10 mL MeOH/H<sub>2</sub>O (60:40 v/v), and subsequently injected in the MCFIA system.



b) Liquid-liquid extraction. The sample of EVOO (10 g) was weighted with a precision of 0.1 g and dissolved in 10 mL of hexane. The solution was loaded into a 100-mL separatory funnel and 3 mL of a MeOH/H<sub>2</sub>O (60:40 v/v) solution were added. The mixture was vigorously shaken for 2 min and the hydroalcoholic phase (lower) collected into a 10-mL volumetric flask. This extraction step was repeated two times more, being the three hydroalcoholic phases combined in the same flask. Finally, the volumetric flask is made up to the mark with distilled water and the solution was injected in the flow system.

### **2.3. Reference methods**

#### **2.3.1. Reference method for the determination of PV in the olive oil samples.**

Peroxide value determination in olive oil samples was performed by using the official method described in Regulation (EEC) No 2568/91 (European Commission 1991). Briefly, the oil was dissolved using chloroform and glacial acetic acid was added getting an acid medium. Then, a potassium iodide saturated solution was added. The iodide ion reacts with the peroxide and forms triiodide ion. Then, the titration of triiodide ion formed was made using thiosulfate sodium as titrant and starch as indicator.

#### **2.3.2. Reference method for phenolic compounds determination in olive oil samples**

The colorimetric FC reagent-based method described in (Lara-Ortega et al. 2016) was used as reference method for total phenolic compounds analysis.

### **2.4. MCFIA-Chemiluminescence Detector assembly**

CL measurements for both PV and phenolic compounds were carried out using a Hamamatsu H8249-101 photosensor module (Japan) with a power supply Cebek FE- 74 ( $\pm$  15V, 1 A). connected to a transformer with balanced output (Saber ref. 16,045 (230V, 18-0-18, 2A)). A controllable source of power PS1503SB (0-15V, 3A) was used to adjust the gain of the photomultiplier module. To obtain the signal voltage of the photosensor, a connector NI SCB -68 Shielded Connector Block was used. It was connected by a

shielded wire SHC68-68EPM to an interface NI PCI - 6221 M Series Multifunction DAQ device from National Instruments (Madrid, Spain) used as analog-to-digital converter. The acquired data were recorded using a personal computer with the original Data Logging VI Logger Software 2.0 (National Instruments). The acquired data were smoothed using the software Origin Pro 8 (Origin Lab Corporation, Northampton MA USA). A scheme of this modular system is depicted in Fig. 1.

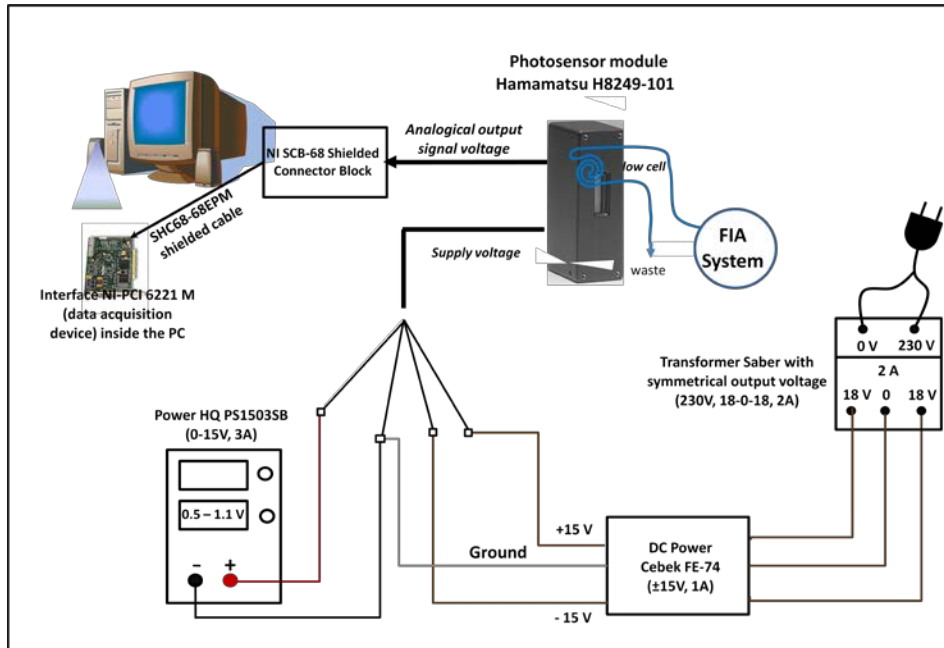

Figure 1. Modular MCFIA CL system scheme.

## 2.5. MCFIA system

### 2.5.1. For PV determination

The scheme of the multicommuted-FIA system for PV determination is depicted in Fig. 2A. A four-channel Gilson Minipuls-3 peristaltic pump (Villiers Le Bell, France) with rate selector and pump tubing type Solvflex of 1.27 mm i.d (Elkay Products, Shrewsbury, MA, USA) was used to propel de solutions through the flow network. Two 161T031 NResearch three-way solenoid valves (NResearch, Northampton, UK) were employed to manage the flow pathway, making the solutions either to recirculate to their vessels or, alternatively driving them towards the detector. An electronic interface, based on ULN 2803 integrate circuit was used to control the valves, which were operated with an electric potential of 12V and a direct current of 100 mA. The homemade software for controlling the solenoid valves was developed in Java. Teflon tubing (0.8 mm i.d.) and teflon fittings (Omnifit Ltd. Cambridge, UK) were used for merging solutions.

### 2.5.2. For phenolic compound determination

The scheme of the MCFIA system for the direct CL determination of phenolic compounds is depicted in Fig. 2B. The peristaltic pump, the pump tubing, the three-way solenoid valves (three valves in this case), the teflon tubing and fittings and the electronic interface, were the same type as those for the PV MCFIA system. Also, the homemade software for controlling the solenoid valves was the same one.

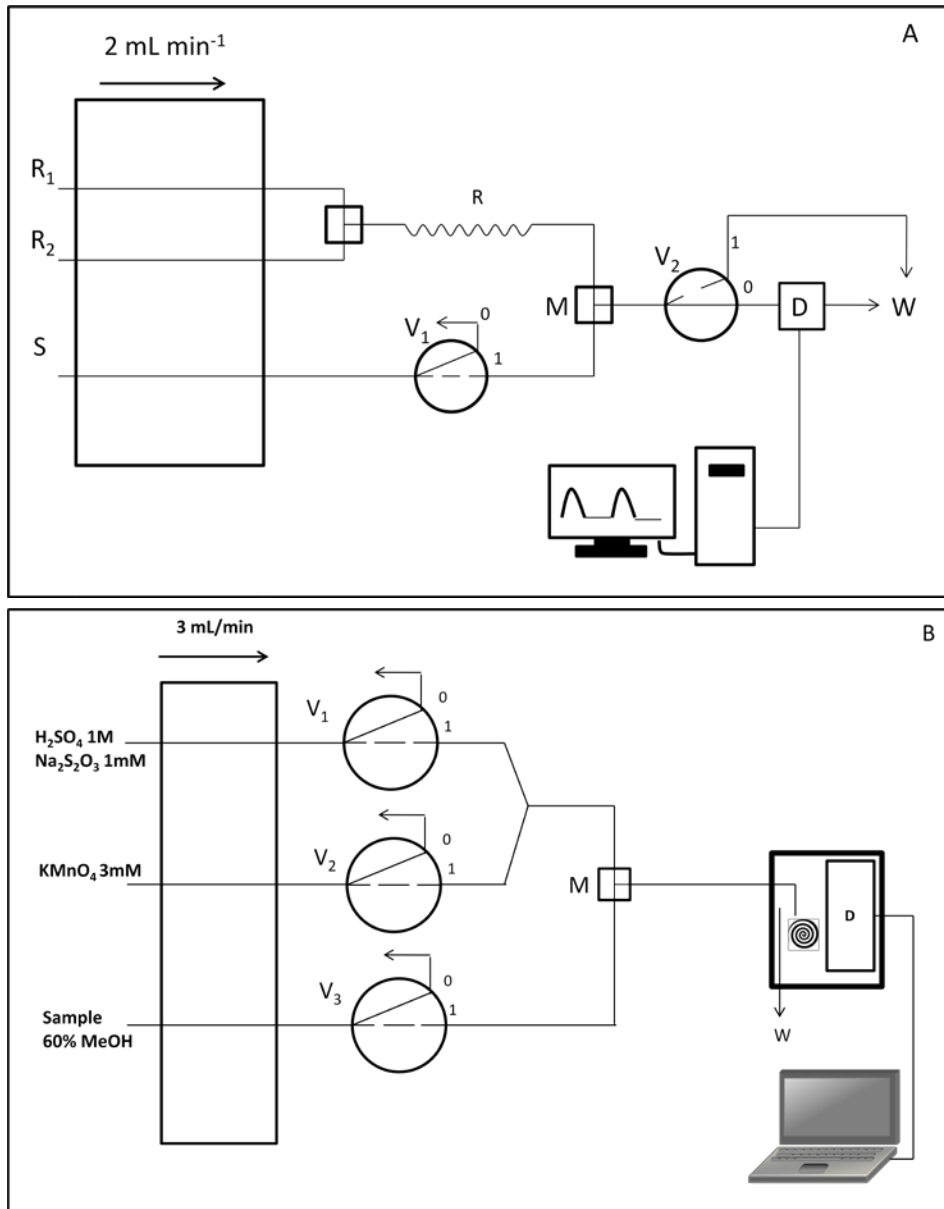

Figure 2. Multicommutated flow injection CL network schemes. A) for PV determination.  $R_1$  and  $R_2$ : luminol and cobalt (II) solutions.  $S$ : olive oil solution sample. B) for phenolic compounds determination.

## 2.6. General procedure

### 2.6.1. For PV measurements

When the solenoid valve 1 ( $V_1$ ) is switched off, samples recirculate through the exit #0 to its vessel. If this solenoid valve is switched on, samples flow through the exit #1 to solenoid valve 2 ( $V_2$ ).  $V_2$  allows the flow of the solutions through the exit #0 to the detector when is switched off. On the other hand, when  $V_2$  is switched on, solutions flow to the waste through the exit #1.

In the initial status, sample is circulating to its vessel, and reagents (luminol,  $R_1$  and cobalt (II),  $R_2$  solutions) flow through the reactor coil for mixing in the merging point (M in Fig. 2A) and go to the detector through valve  $V_2$ . Then,  $V_1$  and  $V_2$  are switched on during 5 s and 10 s respectively, so the system is filled with the sample to be measured just till the merging point with the reagents (M), and reagents going to waste. At this point the sample is ready to be inserted: switching on  $V_1$  during 5 s, sample is merged with the reaction mix reaching the detector through valve  $V_2$  (switched off) and developing the luminescence signal. Measurements were performed by triplicate injections (see Table 1 with the valves switching procedure).

Before the insertion of next sample, the conditioning step is also performed with the same purpose previously described. Thus, the maximum sampling frequency of the MCFIA system is about  $45 \text{ h}^{-1}$  with a flow rate of  $2 \text{ mL min}^{-1}$ . A typical profile of the signal obtained from an EVOO after forced oxidation is shown in Fig. 3A.

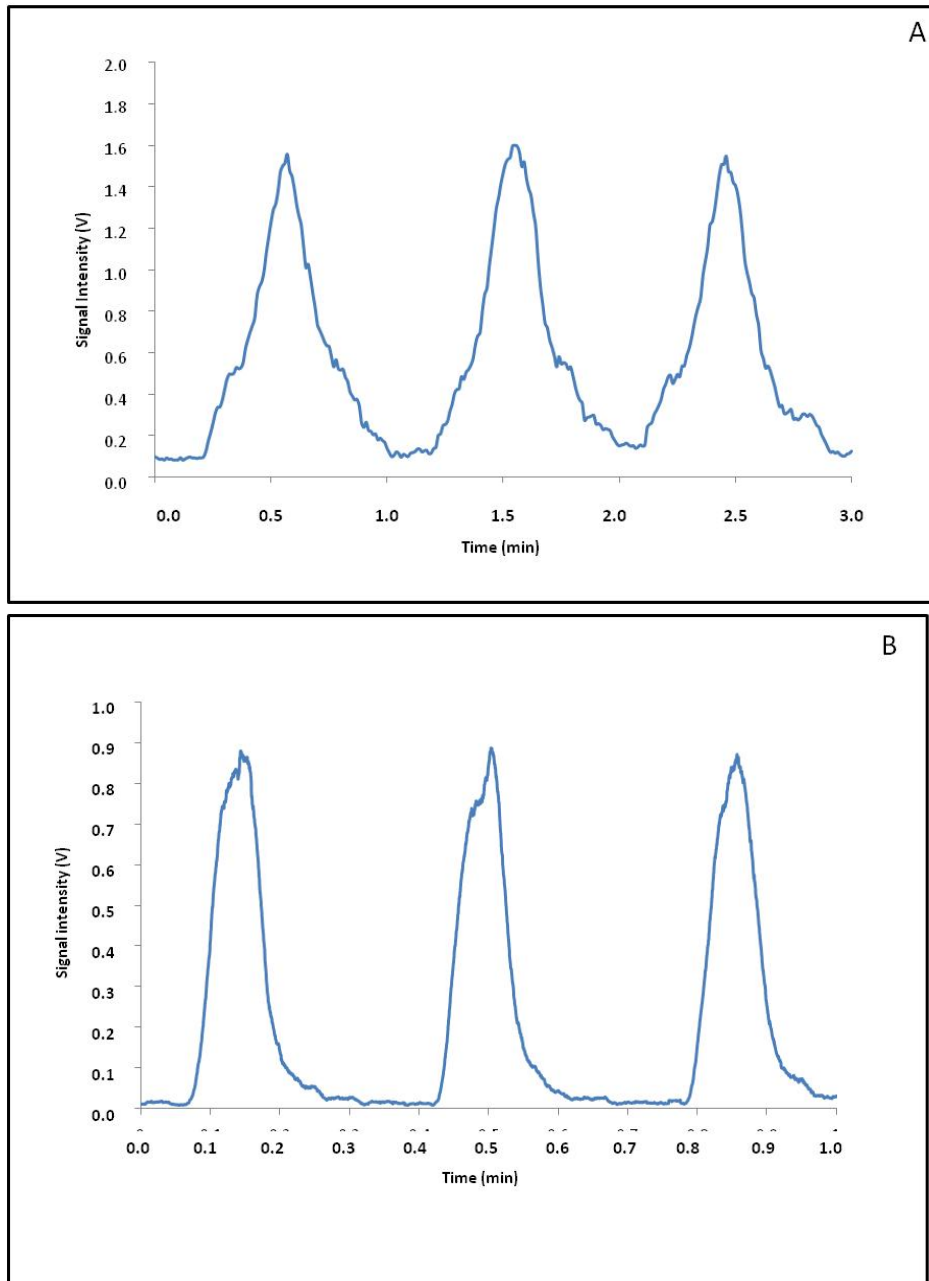

Figure 3. Typical CL diagrams for: (A) PV of an oxidised EVOO analysis; and (B) phenolic compounds of an EVOO.

Table 1. Valve switching scheme for PV measurements.

Step	V1	V2	Analysis time (s)	Description
1	0	0	0	Preparation Step: Fill the part of the network between V <sub>1</sub> and M with sample and discard rest of previous sample between M and V <sub>2</sub>
	1	1	5	
	0	1	10	
2	1	0	15	Sample Injection (5 s) and peak acquisition (65 s)
	0	0	80	

### 2.6.1. For phenolic compounds measurements

In the initial status ( $t = 0$ ), the carrier solution and the oxidizing reagent are allowed to flow to the photosensor through valves V1 and V2 (which are switched on). Then, after 5 s the sample is inserted by switching on the valve V3 during 5 s. The reagents are still circulating through the system until  $t = 20$  s., developing the CL signal when the sample plug, after merging with them (point M in the manifold), reaches the photosensor. The system shows a maximum sampling frequency about  $180 \text{ h}^{-1}$  with a flow rate of  $3 \text{ mL min}^{-1}$ . The valves switching procedure is shown in Table 2. A typical profile of the signal obtained from an EVOO after forced oxidation is shown in Fig. 3B.

Table 2. Valve switching scheme for phenolic compounds measurements.

Step	V1	V2	V3	Analysis time (s)	Description
1	1	1	0	0	Fill the system with reagents previous to sample injection
	1	1	0	5	
2	1	1	1	10	Sample injection (5 s) and peak acquisition (10 s)
	1	1	0	20	

### 3. Results and discussion

#### A) MCFIA method for PV

The present MCFIA method for PV is based on the CL produced in an homogeneous organic medium (1-PrOH) by reaction between luminol and lipid hydroperoxides in presence of Co(II) as catalyst. Chemical and flow system variables were optimized as follows.

#### 3.1. Chemical variables optimization

##### 3.1.1. Choice of solvent

The first step in the study was the selection of the appropriate solvent in which the reaction has to be performed. Due to the intrinsic lipophilic character of the olive oil, the use of organic reagents is necessary (surfactants are not recommended as the reaction of the luminol with peroxides compounds is incomplete due to the fact that the reaction place is limited to the oil–water interface of the oil droplets and it could make that not all lipid hydroperoxides react with the CL reagent (Bunting and Gray 2003a; Bezzi et al. 2008; Tsiaka et al. 2013). In the official method, PV is determined by measuring the amount of triiodide formed by reaction of hydroperoxides with iodide ion using chloroform (10 mL/sample) as solvent (European Comission 1991): however it is hazardous, very toxic and contaminant. Therefore, we tested other (preferably environmental friendly) solvents able to form homogeneous solution: 1-Propanol (1-PrOH), 2-Propanol (2-PrOH), 1-Butanol and acetone. The last one has a high volatility and, moreover, degrades pump tubing very quickly, therefore it was discarded. 1-Butanol does not form a monophasic with basic aqueous solution and was discarded too. Finally, 1-PrOH showed lower background signal than 2-PrOH, so 1-PrOH (environmental friendly and nonhazardous solvent) was chosen.



### 3.1.2. Choice and optimization of the catalyst and luminol concentrations.

Luminol (5-amino-2,3-dihydro-1,4-phthalazinedione) is the most important and familiar chemiluminescent compound. Its chemiluminescent reaction is catalyzed by many different types of substances such as metal ions [Co(II), Cu(II), Fe(II), etc.], ferricyanide and some metallocomplexes (hemin, haemo-globin and peroxidases). Recently, luminol has proved to be an useful CL reagent to evaluate PV and antioxidant activity of olive oil samples either in emulsions or in organic media (Bezzi et al. 2008). Luminol has also been used to measure PV in other types of oil in emulsified solutions (Bunting and Gray 2003). For these reasons, luminol was chosen to develop the present procedure. In alkaline solution, luminol is under anionic form, which is oxidized to diazami-quinone radical from the hydroperoxydes. Next, diazamiquinone reduces  $O_2$  to superoxide anion ( $O_2^{\bullet-}$ ) and is oxidized to 5-aminohyphenthalazine-1,4-dione. According to Tsiaka et al. (Tsiaka et al. 2013), the reaction follows the typical described chemilumino-genic pattern of luminol oxidation involving diazamiquinone radical and superoxide anion, emitting finally light and generating aminofalate and  $N_2$ .

Most commons catalysts for CL reactions described in literature involve transition metal ions such a Fe (III), Mn (II) and Co (II) and their complexes ( Tsiaka et al. 2013; Stepanyan et al. 2005; Bezzi et al. 2008;). Hemin (iron-containing porphyrin) is another studied catalyst for olive oil CL reactions (Bezzi et al. 2008). In this study, Co(II) (one of the more used catalysts with luminol), Co(II)-EDTA complex and hemin were tested as catalysts (all of these three catalysts have been used in luminol CL studies and assays of oxidation of oils described in literature (Matthäus et al. 1994; Bezzi et al. 2008, Rolewski et al. 2009 ). The results showed that Co (II) solution enhanced the CL signal more than its EDTA complex and hemin solutions. Next, three different concentrations of Co (II) were tested: 25, 50 y 100 mg  $L^{-1}$ . The best signal was obtained with 25 mg  $L^{-1}$ ; it is probably due to fact that the catalytic action is already complete from this concentration while a higher concentration gives a more intense color of the solution, so decreasing the signal intensity produced in the CL reaction, which is reaching the photosensor.

Regarding the influence of luminol concentration, three values were tested using the optimized Co(II) concentration of 25 mg L<sup>-1</sup>: 200, 500 and 1000 mg L<sup>-1</sup> and the optimum signal was obtained with 1000 mg L<sup>-1</sup>, which was chosen as optimum value.

### 3.1.3. Dilution of oil samples

Several dilutions of oil sample in 1-PrOH (all of them originating homogeneous solutions) were tested: 5:100, 10:100 and 15:100 (w:v (g:mL) of final solution) and injected in the MCFIA system and the best ratio signal/noise was obtained by the last one, which was chosen as the optimum value.

### 3.2. Flow system variables optimization

The sample and reagents flow rate provided by the peristaltic pump, as well as sample insertion time (by operating the 3-way solenoid valves) were studied and optimized. The flow rate was investigated from 1.6 to 2.7 mL min<sup>-1</sup>. Low flow rate values originated practically no CL signal because the reaction bulk reached the detector after the CL reaction was completed. On the other hand, high flow rate values produced the contrary effect, so low CL was obtained as the reaction bulk reached the detector too quickly regarding the kinetic of the reaction. According to these results, a flow rate of 2.0 mL min<sup>-1</sup> was adopted as the optimum value.

In this MCFIA network, sample volume is controlled by means of the electronic interface by varying appropriately the insertion time via software, which allows to send the appropriate current pulses to the solenoid valves for their activation. The studied range for the introduction of sample was varied from 3 to 10 s. With a short injection time, the sample volume injected was not enough to get any CL signal; on the other hand, a too long injection could saturate the CL signal, in the cases of oxidized olive oil samples. Finally, as a compromise solution, 5 s (estimated sample volume inserted about 166 µL) was the insertion time chosen as the optimum one.

Finally, the influence of reaction coil length was studied. The reactor is necessary to mix the reagents (luminol and the catalyst) just before merging with the sample to obtain the

CL signal. The reactor length was studied from 0.5m to 2m and no signal difference was found. Therefore, 0.5 m was used. Table 3 shows optimized values for all variables.

Table 3. Optimized values for chemical and flow variables of the two procedures.

Peroxide value proposed method		Phenolic compounds proposed method	
Parameter	Optimum value	Parameter	Optimum value
Sample dilution in 1-PrOH	1.5:10 w:v (g:mL)	Sample percent MeOH	60% (v:v) aqueous solution
[Luminol] in 1-PrOH (with NaOH 4 g L <sup>-1</sup> )	1.0 g L <sup>-1</sup>	[KMnO <sub>4</sub> ]	3.0 × 10 <sup>-3</sup> M
[Co (II)] in 1-PrOH	25 mg L <sup>-1</sup>	[H <sub>2</sub> SO <sub>4</sub> ]	1.0 M
Flow rate	2 mL min <sup>-1</sup>	[Na <sub>2</sub> S <sub>2</sub> O <sub>3</sub> ]	0.16 g L <sup>-1</sup>
Reactor length	0.5 m	Flow rate	3 mL min <sup>-1</sup>
Insertion time/sample volume	5s/166 µL	Insertion time/sample volume	5s/250 µL

### 3.3. Analysis of olive oil samples.

Twelve olive oil samples were analyzed following the described general procedure. Eight of them are local market-purchased EVOO samples, other three samples were from EVOO previously oxidized by heating at 180 °C by time periods of one, two and three hours respectively; and the last one was an olive oil (mix from VOO and ROO). Calibration line in the range 12.3 – 215.5 meq O<sub>2</sub> kg<sup>-1</sup> olive oil was made using olive oils samples whose peroxide value was previously measured by the official method (European Commission 1991). The calibration equation was  $y = 0.0527x - 0.7213$ , ( $r = 0.9999$ ;  $S_{y/x} = 0.0501$ ;  $S_a = 0.0204$ ;  $S_b = 0.0002858$ ) where  $y$  = analytical signal (V, volts) and  $x$  = PV (meq O<sub>2</sub> kg<sup>-1</sup> olive oil);  $S_{y/x}$  = standard deviation of estimate PVs from the proposed method regarding the respective ones predicted by the regression equation;  $S_a$  and  $S_b$  = standard errors for intercept and slope, respectively. The relative standard deviation found for the replicate analysis (n=4) of an EVOO was 2.2 %.

The CL signal of the 12 samples analyzed was interpolated in the calibration line and the respective PVs by the proposed method were obtained. A very good correlation between the official method and the proposed method was found in the established range 12.3 – 215.5 meq O<sub>2</sub> kg<sup>-1</sup> olive oil given by the regression equation  $y = 0.9973x + 0.5585$  ( $r = 0.9999$ ;  $S_{y/x} = 0.4983$ ;  $S_a = 0.01746$ ;  $S_b = 0.0025$ ) where  $y$  and  $x$  are the PVs (expressed as meq O<sub>2</sub> kg<sup>-1</sup> oil) from the developed MCFIA CL method and the official reference one, respectively (Fig. 4).

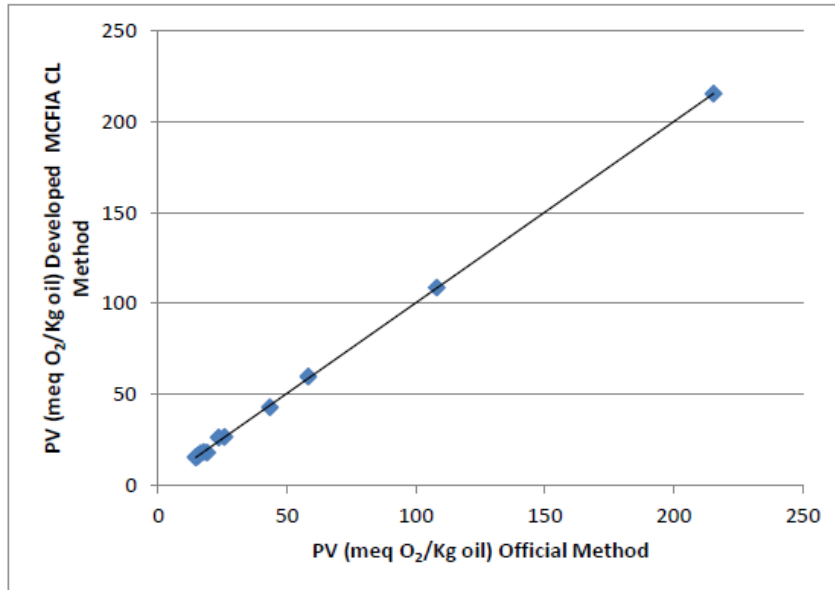

Figure 4. Correlation between PV results from the proposed and reference method.

From the result obtained, it can be concluded that the proposed automatic method is suitable to be implemented in routine analysis laboratories for determination of PV in commercial olive oils with a much higher sample throughput than official method, good reproducibility, simplicity and cost-effectiveness.

### B) MCFIA method for phenolic compounds

As above mentioned, it is expected that phenolic compounds in olive oil can produce direct CL emission when reacting with permanganate in acid medium. Previous assays performed in our laboratory confirmed this hypothesis working with a liquid-liquid VOO

extract prepared as indicated in section 2.2.2.b. Consequently, optimization of the respective variables was performed.

### 3.4. Chemical variables optimization

The influence of  $\text{KMnO}_4$ ,  $\text{H}_2\text{SO}_4$  concentrations, as well as the MeOH percentage in the sample were studied and optimized. Gallic acid was used as model phenol compound analyte.  $2.0 \times 10^{-3}$ ,  $3.0 \times 10^{-3}$ , and  $4.0 \times 10^{-3}$  M  $\text{KMnO}_4$  solutions were assayed for four different concentrations of gallic acid: 50, 100, 200 and 300  $\text{mg L}^{-1}$  in 60% aqueous MeOH (v:v) and a 1.0 M  $\text{H}_2\text{SO}_4$  solution. The analytical CL signal was very similar for gallic concentrations bellow 300  $\text{mg L}^{-1}$  for the tested  $\text{KMnO}_4$  concentrations. However,  $4.0 \times 10^{-3}$  M  $\text{KMnO}_4$  concentration gave a significant lower signal than that obtained for  $3.0 \times 10^{-3}$  M. Therefore,  $3.0 \times 10^{-3}$  M was chosen as the optimum  $\text{KMnO}_4$  concentration (Fig. 5) for further studies.

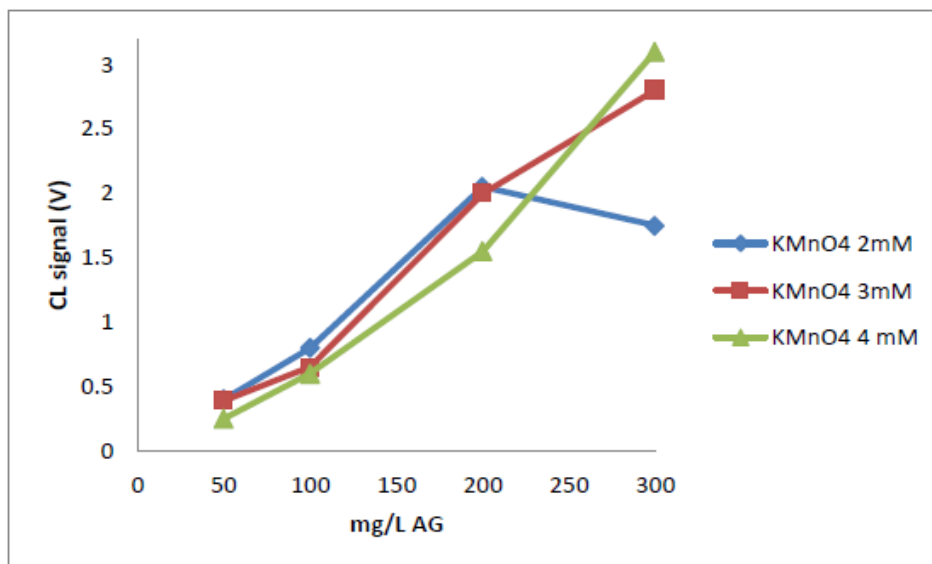

Figure 5. Effect of  $\text{KMnO}_4$  concentration on the CL signal.

The effect of  $\text{H}_2\text{SO}_4$  concentration was studied from 1.0 to 6.0 M for a gallic acid concentration of 100  $\text{mg L}^{-1}$  (60% aqueous MeOH (v:v)). The results (Fig. 6) showed the highest CL signal for a concentration 1.0 M. Higher concentrations originated lower signal. Then,

the study was repeated with a  $\text{KMnO}_4$  concentration of  $6.0 \times 10^{-3}$  M in order to check that oxidant concentration was not a limiting factor. In this case, the CL signal was not influenced by  $\text{H}_2\text{SO}_4$  concentration in the studied range and, moreover, the signal was lower than that obtained with the previously optimized  $\text{KMnO}_4$  concentration, probably due to CL radiation absorption by the  $\text{KMnO}_4$  solution itself at this higher concentration. Therefore, 1.0 M  $\text{H}_2\text{SO}_4$  concentration was selected as the optimum one.

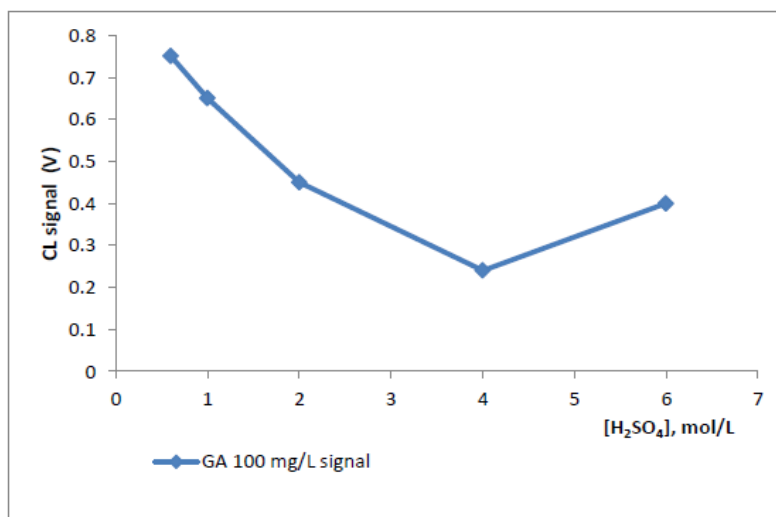

Figure 6. Effect of MeOH concentration on the CL signal.

The effect of MeOH concentration on the CL signal of gallic acid was tested from 0 to 60% (MeOH/H<sub>2</sub>O v:v) for a gallic acid concentration ranging from 100 to 300 mg L<sup>-1</sup>. There were no significant differences in the CL signal (Fig. 7) and, therefore, the concentration selected was just the same as that used for the phenol compounds extracting solution (MeOH:H<sub>2</sub>O 60:40 (v:v)).

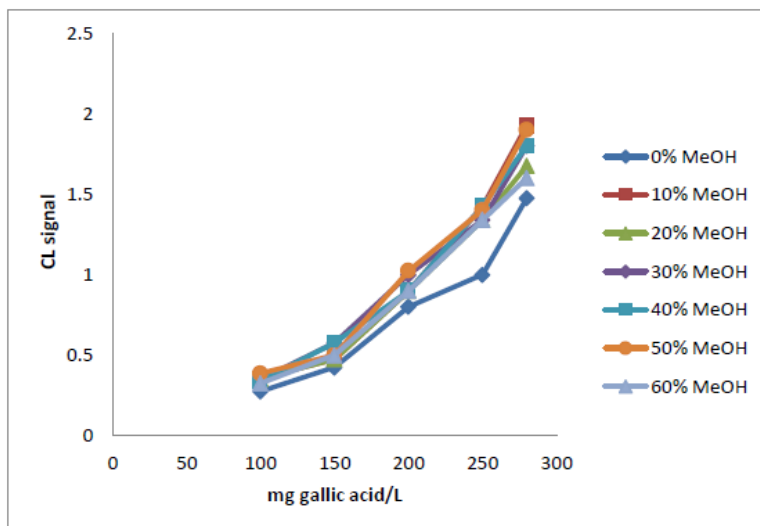

Figure 7. Effect of MeOH concentration on the CL signal.

Finally, the use of a CL enhancer agent in the carrier stream was tested under the previous optimized conditions (for a gallic acid concentration of 100 mg L<sup>-1</sup>). From the results obtained (Fig. 8) 1.0x10<sup>-3</sup> M concentration of thiosulfate was decided to add to the 1.0 M H<sub>2</sub>SO<sub>4</sub> carrier solution as it increased the CL signal about a factor of 7 without blank signal increasing.

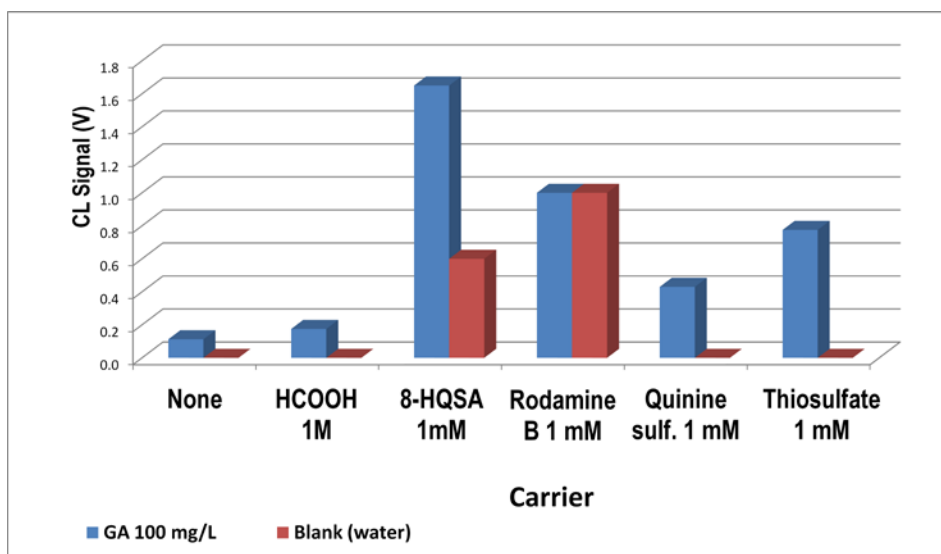

Figure 8. Study of CL enhancer

### 3.5. Flow system variables optimization

The influence of flow system variables was studied. The flow rate was investigated in the range 1.0-3.5 mL min<sup>-1</sup> y a maximum CL signal was reached for 3.0 mL min<sup>-1</sup>, so this flow rate was used for further experiments. On the other hand, a sample insertion time of 5 s (estimated sample volume inserted about 250 µL) was the appropriate one as a compromise between signal response and sample throughput. Table 3 shows optimized values for all variables.

### 3.6. Determination of phenolic compounds in EVOO

To quantify phenolic compounds in EVOO samples by applying the developed procedure and previous extraction by means SPE or LLE, two representative phenolic compounds (tyrosol and gallic acid) and Trolox were tested as standards to calibrate the method. Gallic acid showed a very high CL signal compared to that from EVOO samples response, so very narrow concentration range could be used for calibration, thus resulting in a very short range of phenol compounds concentrations obtained for the samples analyzed and it was discarded as calibrating agent for the CL system. Tyrosol and trolox gave a CL response signal similar to that from EVOO. However, trolox showed better linear calibration equation ( $r = 0.9968$ ) against tyrosol ( $r = 0.9463$ ).

Fourteen EVOO samples were analyzed after performing the two different sample treatments (SPE and LLE) previously described (see experimental section) by injecting the sample extracts for 5 s. in the MCFIA system operating in the optimized conditions described. The CL signals obtained were transformed in the respective phenolic contents from the calibration equation lines and expressed, respectively, as mg of trolox/ tyrosol per kg of sample. Then, the correlation of these results with those from reference method was studied. It was found that the results of samples with SPE treatment showed worse correlation ( $r = 0.8669$ ) than those from LLE using trolox for calibration, which followed the correlation equation (see Fig. 9A)  $y = 0.5237x + 68.84$  ( $r = 0.9442$ ;  $S_{y/x} = 27,13$ ;  $S_a = 20,73$ ;  $S_b = 0,05340$ . ) where  $y$  = phenolic content (mg gallic acid kg<sup>-1</sup> oil from the reference method) and  $x$  = phenolic content from the CL developed method (mg trolox kg<sup>-1</sup> oil). When tyrosol was used as calibrating agent, it was also found a good



correlation according to equation (Fig. 9B):  $y = 0.3226x + 139.73$  ( $r = 0.9442$ ;  $S_{y/x} = 26,80$ ;  $S_a = 4,49$  ;  $S_b = 0,03250$ ) where  $y$  = phenolic content (mg gallic acid  $\text{kg}^{-1}$  oil from the reference method) and  $x$  = phenolic content from the CL developed method (mg tyrosol  $\text{kg}^{-1}$  oil). The relative standard deviation found for the replicate analysis ( $n = 6$ ) of an EVOO was 2.1 % using LLE and 4.1 % if SPE ws used.

a)

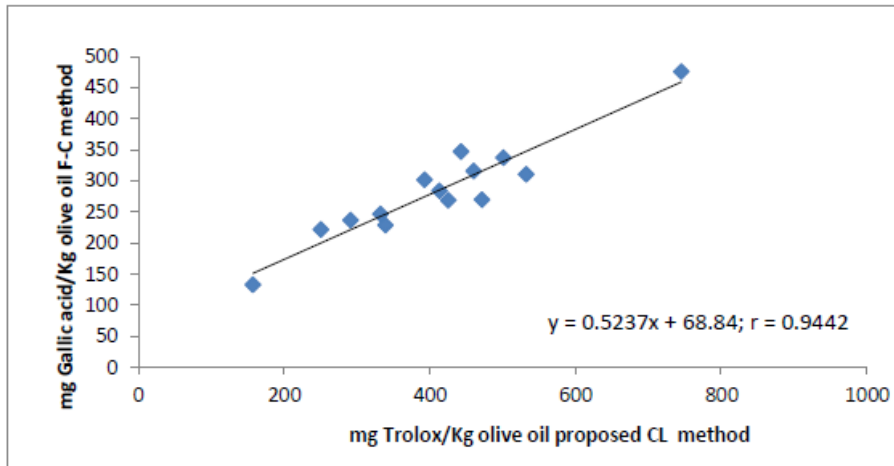

b)

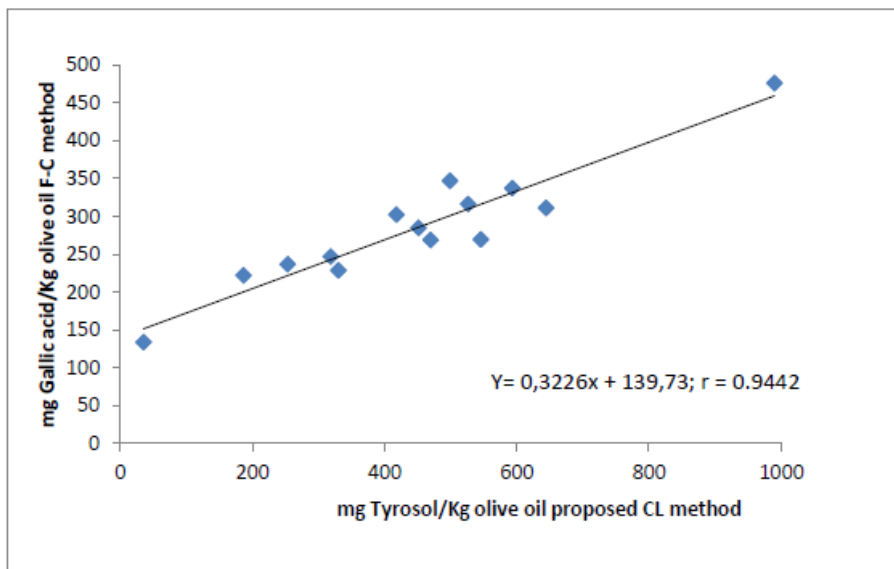

Figure 9. Phenolic compounds results correlation between the proposed and reference procedures. a) Proposed procedure calibration with Trolox. b) Proposed procedure calibration with Tyrosol.

From these results, the proposed method based on direct CL oxidation of phenol compounds is suitable for semiquantitative estimation or screening of these compounds in EVOO with interesting advantages such as rapidity (180 samples (extracts)/h), automatization and less both reagent consumption and waste as compared to the classical FC procedure. Thus, it exhibits appropriate features to be implemented in routine analysis laboratories where a high number of samples should be analyzed per day.

#### **4. Concluding remarks**

In this work, two MCFIA-CL methods have been developed for the determination of PV and phenolic compound/antioxidants in olive oils, based on the CL produced by luminol and the olive oil hydroperoxide (PV determination) and on the direct permanganate CL emission from the aqueous extracts of olive oil (phenolic compounds/antioxidants determination). These methods have been applied to commercial olive oil samples (even, in the case of PV, to EVOO oxidized by heating in the laboratory). From the positive results obtained in this study, we can conclude that the proposed methods are suitable to evaluate these two olive oil parameters, showing appropriate features to be implemented in routine analysis laboratories. It should be highlighted that, to the best of our knowledge, no direct CL emission (phenolic compounds determination) has been previously applied to automatic olive oil analysis. Additional attractive advantages over the official/classical method includes simplicity, higher sampling frequency, automation and much lower sample and reagent consumption, avoiding the use of toxic chlorinated solvents.

#### **5. Acknowledgements**

The authors acknowledge funding support from the Regional Government of Andalusia (Spain), Junta de Andalucía (Project AGR-6066 and Research Group FQM323). F.J.L.-O. acknowledges a Ph.D. scholarship from MINECO, Spain (Ref. BES-2013- 064014).

### **Compliance with Ethical Standards**

**Conflict of Interest** Felipe J. Lara-Ortega declares that he has no conflict of interest. Bienvenida Gilbert-López declares that she has no conflict of interest. Miriam Beneito Cambra declares that she has no conflict of interest. Antonio Molina-Díaz declares that he has no conflict of interest.

**Ethical Approval** This article does not contain any studies with human participants or animals performed by any of the authors.

**Informed Consent** Not applicable.

---

## References

- Adcock JL, Francis PS, Barnett NW (2007) Acidic potassium permanganate as a chemiluminescence reagent — A review. *Anal Chim Acta* 601:36–67. doi: 10.1016/j.aca.2007.08.027
- Akasaka K, Takamura T, Ohrui H, Meguro H, Hashimoto K (1996) Highly Sensitive Flow Injection Analysis of Lipid Hydroperoxides in Foodstuffs. *Biosci Biotechnol Biochem* 60:1772–1775. doi: 10.1271/bbb.60.1772
- Armenta S, Garrigues S, de la Guardia MD (2007) Determination of edible oil parameters by near infrared spectrometry. *Anal Chim Acta* 596:330–337. doi: 10.1016/j.aca.2007.06.028
- Artajo L-S, Romero M-P, Suárez M, Motilva M-J (2007) Partition of phenolic compounds during the virgin olive oil. *Eur Food Res Technol* 225:617–625. doi: 10.1007/s00217-006-0456-0
- Bezzi S, Loupassaki S, Petrakis C, Kefalas P, Caloferinos AC (2008) Evaluation of peroxide value of olive oil and antioxidant activity by luminol chemiluminescence. *Talanta* 77:642–646. doi: 10.1016/j.talanta.2008.07.019
- Bunting JP, Gray DA (2003) Development of a Flow Injection Chemiluminescent Assay for the Quantification of Lipid Hydroperoxides. *J Am Oil Chem Soc* 80:951–955. doi: 10.1007/s11746-003-0802-1.
- Carrasco-Pancorbo A, Cerretani L, Bendini A, Segura-Carretero A, Gallina-Toschi T, Fernández-Gutiérrez (2005) Analytical determination of polyphenols in olive oils. *J Sep Sci* 28:837–858. doi: 10.1002/jssc.200500032
- Chotimarkorn C, Ohshima T, Ushio H (2005) Fluorometric and Fluorescent Image Analysis Methods for Determination of Lipid Hydroperoxides in Oil Models with 3-Perylene Diphenylphosphine (3-PeDPP). *J Agric Food Chem* 53:7361–7366. doi: 10.1021/jf050611g
- Christodouleas DC, Fotakis C, Papadopoulos K, Yannakopoulou E, Calokerinos AC (2009) Development and validation of a chemiluminogenic method for the evaluation of antioxidant activity of hydrophilic and hydrophobic antioxidants. *Anal Chim Acta* 652:295–302. doi: 10.1016/j.aca.2009.08.012
- Christodouleas DC, Fotakis C, Papadopoulos K, Calokerinos AC (2014) Evaluation of

- total reducing power of edible oils. *Talanta* 130:233–240. doi: 10.1016/j.talanta.2014.06.058
- Costin JW, Barnett NW, Lewis SW, McGillivray DJ (2003) Monitoring the total phenolic / antioxidant levels in wine using flow injection analysis with acidic potassium permanganate chemiluminescence detection. *Anal Chim Acta* 499:47–56. doi: 10.1016/S0003-2670(03)00551-8
- Dhaouadi A, Monser L, Sadok S, Adhoum N (2006) Flow-injection methylene blue-based spectrophotometric method for the determination of peroxide values in edible oils. *Anal Chim Acta* 576:270–4. doi: 10.1016/j.aca.2006.06.026
- European Commission EC (1991) Commission Regulation (EEC) No 2568/91 of 11 July 1991. On characteristics of olive oil and olive-residue oil and on the relevant methods of analysis. *Off. J. Eur. Union*
- Granato D, Santos JS, Maciel LG, Nunes DS (2016) Trends in Analytical Chemistry Chemical perspective and criticism on selected analytical methods used to estimate the total content of phenolic compounds in food matrices. *Trends Anal Chem* 80:266–279. doi: 10.1016/j.trac.2016.03.010
- Grossi M, Di Lecce G, Arru M, Toschi TG, Ricò B (2015) An opto-electronic system for in-situ determination of peroxide value and total phenol content in olive oil. *J Food Eng* 146:1–7. doi: 10.1016/j.jfoodeng.2014.08.015
- Gutiérrez F, Fernández JL (2002) Determinant parameters and components in the storage of virgin olive oil. Prediction of storage time beyond which the oil is no longer of "Extra" quality. *J Agric Food Chem* 50:571–577. doi: 10.1021/jf0102158
- Hrnčirik K, Fritsche S (2004) Comparability and reliability of different techniques for the determination of phenolic compounds in virgin olive oil. *Eur J Lipid Sci Technol* 106:540–549. doi: 10.1002/ejlt.200400942
- Lara-Ortega FJ, Sainz-Gonzalo FJ, Gilbert-López B, García-Reyes JF, Molina-Díaz A (2016) Multicommuted flow injection method for fast photometric determination of phenolic compounds in commercial virgin olive oil samples. *Talanta* 147:531–536. doi: 10.1016/j.talanta.2015.10.015
- Matthäus B, Wiezorek C, Eichner K (1994) Fast Chemiluminescence Method for Detection of Oxidized Lipids. *Fat Sci Technol* 96:95–99.
- Michalowski J, Halaburda P, Kojło A (2000) Determination of Phenols In Natural Waters with A Flow-Analysis Method and Chemiluminescence Detection. *Anal Lett*

- 33:1373–1386. doi: 10.1080/00032710008543128
- Nalewajko-Sieliwoniuk E, Malejko J, Pawlukiewicz A, Kojło A (2016) A novel multicom-muted flow method with nanocolloidal manganese(IV)-based chemiluminescence detection for the determination of the total polyphenol index. *Food Anal. Methods*, 991-1001. doi: 10.1007/s12161-015-0274-8
- Nikokavoura A, Christodouleas D, Yannakopoulou E, Papadopoulos K, Calokerinos AC (2011) Talanta Evaluation of antioxidant activity of hydrophilic and lipophilic compounds in edible oils by a novel fluorimetric method. *Talanta* 84:874–880. doi: 10.1016/j.talanta.2011.02.007
- Nouros PG, Georgiou CA, Polissiou MG (1999) Direct parallel flow injection multichannel spectrophotometric determination of olive oil peroxide value, *Anal. Chim. Acta*: 389 239–245
- Papadopoulos K, Triantis T, Yannakopoulou E, Nikokavoura A, Dimotikali D (2003) Comparative studies on the antioxidant activity of aqueous extracts of olive oils and seed oils using chemiluminescence. *Anal Chim Acta* 494:41–47. doi: 10.1016/S0003-2670(03)01013-4
- Rolewski P, Siger A, Nogala-Kalucka M, Polewski K (2009) Chemiluminescent assay of lipid hydroperoxides quantification in emulsions of fatty acids and oils. *Food Res Int* 42:165–170. doi: 10.1016/j.foodres.2008.09.010
- Ross SM (2013) Effects of extra virgin olive oil phenolic compounds and the mediterranean diet on cardiovascular health. *Holist Nurs Pract* 27:303–307. doi: 10.1097/HNP.0b013e3182a0c668
- Saad B, Wai WT, Lim BP, Saleh MI (2006) Flow injection determination of peroxide value in edible oils using triiodide detector. *Anal Chim Acta* 565:261–270. doi: 10.1016/j.aca.2006.02.039
- Schwingshackl L, Hoffmann G (2014) Monounsaturated fatty acids, olive oil and health status: a systematic review and meta-analysis of cohort studies. *Lipids Health Dis*. 13:154 doi: 10.1186/1476-511X-13-154
- Sohn J-H, Taki Y, Ushio H, Ohshima T (2005) Quantitative determination of total lipid hydroperoxides by a flow injection analysis system. *Lipids* 40:203–209. doi: 10.1007/s11745-005-1376-2
- Steenhorst-Slikkerveer L, Louter A, Janssen H-G, Bauer-Plank C (2000) Analysis of nonvolatile lipid oxidation products in vegetable oils by normal-phase high-

- performance liquid chromatography with mass spectrometric detection. *J Am Oil Chem Soc* 77:837–845. doi: 10.1007/s11746-000-0134-1
- Stepanyan V, Arnous A, Petrakis C, Kefalas P, Calokerinos AC (2005) Chemiluminescent evaluation of peroxide value in olive oil. *Talanta* 65:1056–1058. doi: 10.1016/j.talanta.2004.08.041
- Talpur MY, Hussain Sherazi ST, Mahesar SA, Bhutto AA (2010) A simplified UV spectrometric method for determination of peroxide value in thermally oxidized canola oil. *Talanta* 80:1823–6. doi: 10.1016/j.talanta.2009.10.028
- Tian K, Dasgupta (1999) Automated measurements of lipid hydroperoxides in oil and fat samples by flow injection photometry. *Anal Chem* 71: 2053-2058
- Tsiaka T, Christodouleas DC, Calokerinos AC (2013) Development of a chemiluminescent method for the evaluation of total hydroperoxide content of edible oils. *Food Res Int* 54:2069–2074. doi: 10.1016/j.foodres.2013.08.036
- Yu X, Van de Voort FR, Sedman J (2007) Determination of peroxide value of edible oils by FTIR spectroscopy with the use of the spectral reconstitution technique. *Talanta* 74:241–246. doi: 10.1016/j.talanta.2007.06.004
- Wang N, Ma T, Yu X, Xu L, Zhang R (2016) Determination of peroxide values of edible oils by ultraviolet spectrometric method. *Food Anal. Methods* 9:1412–1417. doi 10.1007/s12161-015-0322-4







## IV. 2. Evaluación de nuevas fuentes de ionización para análisis directo de aceite de oliva y determinación de residuos de plaguicidas mediante espectrometría de masas

En esta segunda parte de la Tesis se aborda el estudio de la viabilidad del empleo de nuevas fuentes de ionización para el análisis directo de aceite de oliva y para la determinación de residuos de plaguicidas por espectrometría de masas. Los métodos analíticos basados en la espectrometría de masas por ionización ambiental (AIMS) combinan las excelentes características de la espectrometría de masas en términos de sensibilidad y selectividad con las favorables características que conlleva la ausencia de tratamiento de muestra. En esta parte de la Tesis se evaluó la potencialidad de diferentes métodos basados en espectrometría de masas con ionización ambiental para análisis directo de ciertos parámetros del aceite de oliva virgen con propósitos de caracterización de la muestra. Este es un aspecto muy interesante, teniendo en cuenta la naturaleza hidrofóbica del aceite de oliva, que lo convierte en una matriz muy compleja, que obliga a tratamientos previos de muestra largos y tediosos, inapropiados para análisis en laboratorios de rutina. La posibilidad de prescindir, en este caso, del proceso de preparación de muestra, o de la necesidad de una separación cromatográfica, simplificaría la analítica, abaratando costes y reduciendo considerablemente el tiempo de análisis por muestra.

En el primer artículo, se ha evaluado el uso de la espectrometría de masas directa con dos diferentes fuentes de ionización ambiental (AMIS) para la caracterización del AOV: fuente de plasma de baja temperatura (LTP) y fuente Papel Spray (PS). Las dos presentan un comportamiento diferente entre sí en cuanto al rango de cobertura de ionización de compuestos, pero minimizan el efecto memoria comparado el uso de infusión directa y no originan suciedad en el espectrómetro.

En el segundo artículo, se evalúa el empleo de la fuente de ionización basada en descarga de barrera dieléctrica como interfase para LC-MS con el propósito de minimizar el efecto matriz y obviar la limitación en la cobertura de ionización de compuestos no polares en análisis multiresiduo, respecto a las fuentes convencionales ESI y APCI. Com-

puestos no analizables por LC-MS como son organoclorados, pueden ser analizados con éxito usando esta fuente.

## Artículo 4: Direct olive oil analysis by mass spectrometry: a comparison of different ambient ionization methods

### Resumen

En este artículo se ha desarrollado un método de análisis directo por espectrometría de masas para una matriz tan compleja como el aceite de oliva. Los triglicéridos son sus componentes principales, pero también están presentes una serie de compuestos polares menores y su distribución podría permitir la diferenciación entre distintas categorías comerciales de aceites, localizaciones geográficas y variedades de olivo. El aceite de oliva virgen (VOO) tiene un alto precio de mercado, estando por ello expuesto a fraude por adulteración con aceites de más bajo precio, como son los de semillas y/o aceites de oliva refinados para obtener mayores beneficios económicos. Para combatir este tipo de fraude se requiere una autenticación de las muestras de VOO mediante métodos rápidos, sencillos, directos y precisos que permitan determinar parámetros de calidad, adulteraciones o incluso su origen. Los métodos analíticos ideales requieren una preparación mínima o nula de la muestra. Con este propósito, en el presente trabajo se han estudiado diferentes métodos de espectrometría de masas para el análisis directo de VOO: (1) medición directa de aceite de oliva no tratado utilizando métodos de espectrometría de masas ambientales tales como espectrometría de masa con ionización mediante plasma a baja temperatura (LTP-MS) o espectrometría de masas con ionización mediante papel spray (PS-MS); o alternativamente (2) el uso de la espectrometría de masas de ionización a presión atmosférica por infusión directa utilizando fuentes convencionales de electrospray (ESI) o de ionización química a presión atmosférica (APCI), combinadas con un tratamiento de muestra mínimo consistente en una simple dilución de aceite de oliva (de 1:10 a 1: 1000) con disolventes adecuados, o una extracción rápida líquido-líquido para desplazar la medición hacia fracciones específicas del VOO, como son los compuestos fenólicos y el perfil de ácidos grasos. La técnica de infusión directa con fuentes convencionales resultó ser inapropiada debido a que ensuciaba demasiado el equipo (efecto memoria). Los principales componentes identificados fueron diferentes clases de compuestos fenólicos presentes en los VOO.

En uso de ambos métodos de ionización ambiental ensayados minimiza el efecto memoria comparado con la infusión directa y permiten analizar VOO directamente o tras una previa dilución. La información proporcionada por ambas técnicas es diferente en cuanto a rango de masas ionizadas cubierto. Cabe destacar que el uso de sales de plata en PS ofrece la posibilidad de análisis de compuestos insaturados.

## Direct olive oil analysis by mass spectrometry: a comparison of different ambient ionization methods

(Submitted to Talanta)

Felipe J. Lara-Ortega, Miriam Beneito-Cambra, José Robles-Molina, Juan F. García-Reyes,  
Bienvenida Gilbert-López and Antonio Molina-Díaz\*

Analytical Chemistry Research Group, Department of Physical and Analytical Chemistry,  
University of Jaén, 23071 Jaén Spain

\*Corresponding author: Prof. Antonio Molina-Díaz. Analytical Chemistry Research Group, University of Jaén, edif. B-3, 23071 Jaén, Spain. Tel.: (+34) 953 212147; Fax: (+34) 953 212940. E-mail: [amolina@ujaen.es](mailto:amolina@ujaen.es)

## ABSTRACT

Analytical methods based on ambient ionization mass spectrometry (AIMS) combine the classic outstanding performance of mass spectrometry in terms of sensitivity and selectivity along with convenient features related to the lack of sample workup required. In this work, the performance of different mass spectrometry-based methods has been assessed for the direct analyses of virgin olive oil for quality purposes. Two sets of experiments have been setup: (1) direct analysis of untreated olive oil using AIMS methods such as Low-Temperature Plasma Mass Spectrometry (LTP-MS) or paper spray mass spectrometry (PS-MS); or alternatively (2) the use of atmospheric pressure ionization (API) mass spectrometry by direct infusion of a diluted sample through either atmospheric pressure chemical ionization (APCI) or electrospray (ESI) ionization sources. The second strategy involved a minimum sample work-up consisting of a simple olive oil dilution (from 1:10 to 1:1000) with appropriate solvents, which originated critical carry over effects in ESI, making unreliable its use in routine; thus, ESI required the use of a liquid-liquid extraction to shift the measurement towards a specific part of the composition of the edible oil (*i.e.* polyphenol rich fraction or lipid/fatty acid profile). On the other hand, LTP-MS enabled direct undiluted mass analysis of olive oil. The use of PS-MS provided additional advantages such as an extended ionization coverage/molecular weight range (compared to LTP-MS) and the possibility to increase the ionization efficiency towards nonpolar compounds such as squalene through the formation of Ag<sup>+</sup> adducts with carbon-carbon double bonds, an attractive feature to discriminate between oils with different degree of unsaturation.

### Keywords:

Olive oil, mass spectrometry, direct analysis, low temperature plasma, paper spray

## 1. Introduction

The Mediterranean diet has been long associated to many health benefits, including reduced mortality risk and lower incidence of cardiovascular diseases [1], being virgin olive oil a key component. This vegetable oil is a complex natural product obtained from olives only by physical/mechanic means, where fatty acids and di- and triacylglycerides (DAGs and TAGs, respectively) are the main components, but a series of minor polar compounds are also present, which are distributed characteristically in different types of commercial categories and olive varieties [2]. Extra virgin olive oil is one of the most expensive vegetable oils so that it may be exposed to fraud through adulteration with lower priced edible oils. Since the authenticity of one particular type of oil is important for both health and commercial reasons, there is a continuous need to develop straightforward and accurate methods to determine their source, quality, and possible adulteration. Ideal "green" analytical methods require minimal sample preparation, ideally solvent-free and high-throughput and straightforward sample analysis [3,4].

Available methods for direct oil analysis characterization are based on different spectrometric techniques such as fluorescence [5], vibrational spectroscopy (MIR, NIR and Raman) [6-8] and nuclear magnetic resonance spectrometry [9]). However, to handle olive oil samples, most mass spectrometry-based methods rely on the use of extraction protocols involving liquid-liquid and/or solid-phase extraction [10-12] which are required prior to mass analysis step, with the exception of headspace techniques, that can be used to characterize oils on the basis of the profile of their volatile components [13]. Direct analysis of diluted olive oil has been also proposed by electrospray ionization (ESI) [14,15] and other atmospheric pressure methods including atmospheric pressure chemical ionization (APCI) and atmospheric pressure photoionization (APPI) [16], although, after a batch of samples, this approach may lead to significant carry over effects and instrument contamination due to the lipids nature and their amount. An alternative can be to restrict the direct analysis to the more atmospheric-pressure MS-friendly polar fraction, obtained by simple liquid-liquid extraction with methanol/water mixtures, followed by ESI-MS analysis.



Ambient ionization mass spectrometry methods are an interesting alternative to atmospheric pressure ionization methods (ESI, APCI) since they do not require from little to none sample workup. This feature maps well against the needs of direct methods for olive oil characterization. Amongst the available ambient ionization techniques described in the literature [17,18] several of them employ atmospheric pressure plasmas [19,20], including direct analysis in real time (DART) [21], desorption atmospheric pressure chemical ionization (DAPCI) [22], flowing afterglow-atmospheric pressure glow discharge (FA-APGD or FAPA) [23], plasma-assisted desorption ionization (PADI) [24] or dielectric barrier discharge ionization (DBDI) [25-27]. Some of these ambient ionization techniques have been employed for characterization of edible oils, including olive oil [28-36].

One of the DBDI-based techniques, the low-temperature plasma (LTP) probe, was introduced in 2008 by Cooks and co-workers [26]. It enables solvent-free analysis of trace compounds on solid surfaces and in complex matrices including olive oil [32]. This research group also described paper spray (PS) ionization [37], a low-cost ambient ionization technique which uses a disposable paper triangle as substrate, where a sample aliquot is loaded. Then, ions are directly generated for MS analysis by applying a high voltage to the wetted paper. While the first technique (LTP-MS) offers solvent-free direct olive oil mass analysis, due to partial desorption of species of interest, the second (PS-MS) offers a low-cost, disposable platform, which provides many practical advantages. These two techniques have been scarcely explored for direct olive oil analysis by mass spectrometry.

In this work, with the aim to explore the potential of mass spectrometry for direct olive oil analysis, different approaches have been studied, including: (1) direct measurement of untreated olive oil using the two mentioned ambient mass spectrometric methods (LTP-MS and PS-MS); or alternatively (2) the direct infusion of olive oil through an ESI source after sample dilution with appropriate solvents or combined with a previous sample extraction using methanolic/water mixtures in order to shift the measurement towards a specific part of the composition of the edible oil (*i.e.* polyphenol rich fraction or lipid/fatty acid profile) to simplify the sample extract exposed to the mass spectrometry atmospheric pressure inlet. Different experiments have been accomplished to allow a comparison of the selected approaches tested.

## 2. Experimental

### 2.1. Chemical and reagents

Silver nitrate, HPLC grade methanol and acetonitrile were obtained from Sigma-Aldrich (Madrid, Spain). Methanol, 2-propanol, chloroform and dichloromethane were obtained from Fluka (Buchs, Switzerland). A Milli-Q-Plus ultra-pure water system from Millipore (Milford, MA, USA) was used throughout the study to obtain the HPLC-grade water used during the analyses. Whatman 42 filter paper (pore size 2.5  $\mu\text{m}$ ) was purchased from Whatman (Whatman International Ltd., Maidstone, England) for paper spray studies. Microscope glass slides (beveled micro slides; size 76  $\times$  26 mm, Deltalab, S.L., Barcelona, Spain) were used in LTP as sample holder.

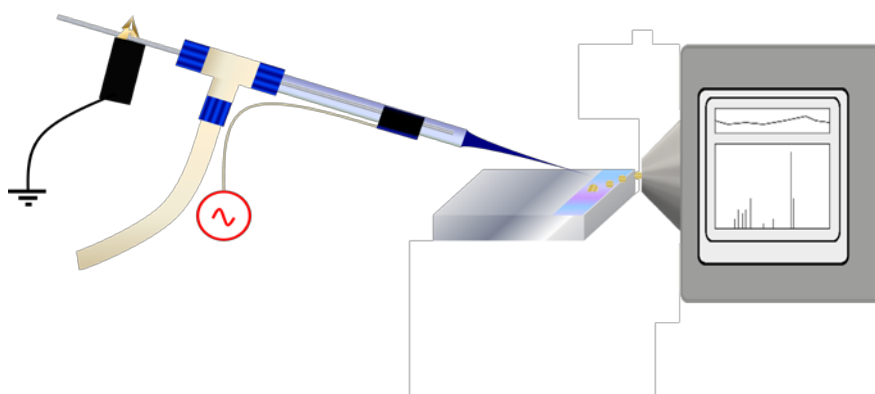

Figure 1. Scheme of the LTP probe used for ambient ionization mass spectrometry.

### 2.2. Sample preparation

Different Spanish olive oils from different commercial categories (extra virgin olive oil (EVOO), virgin olive oil (VOO), and lampante olive oil (LOO)) used in this work were kindly supplied by Instituto Andaluz de Investigación y Formación Agraria, Pesquera, Alimentaria y de la Producción Ecológica, Estación de Olivicultura y Elaiotecnia CIFA 'Venta del Llano' (Mengibar, Spain). Three different approaches were tested for the analysis of compounds of interest in olive oils.

(a) *Without sample preparation (direct raw analysis)*. This was only attempted with LTP ionization. 3  $\mu\text{L}$  of crude untreated olive oil was pipetted in a glass slide placed in front of the mass spectrometer (5 mm) and subjected to LTP-MS analysis.

(b) *Dilution*. Raw oils without any further sample preparation were diluted in chloroform or isopropyl alcohol (1000-fold) [16].

(c) *Liquid-liquid extraction (LLE)*. A straightforward LLE procedure using methanol/water was adapted from previous recent studies to prepare olive oil extracts including mainly the fraction of phenolic compounds [14,38]. Each sample was processed as follows: 10 g of oil was weighed (with a precision of 0.1 mg) and dissolved in 50 mL of hexane. The mixture was loaded into a 100-mL separatory funnel and a liquid-liquid extraction (LLE) was performed. For this purpose, 10 mL of a solution of methanol/water (60:40 v/v) were added and the mixture was vigorously shaken for 3 min. After phase separation, the hydroalcoholic phase (lower) was collected in a 50-mL volumetric flask. The extraction was repeated two times more for each sample, and the hydroalcoholic phases were combined. Finally, the extracts were diluted to the mark with distilled water.

### *2.3. Mass spectrometer*

Experiments were performed in a Thermo LTQ linear ion trap mass spectrometer (Thermo Scientific, San José, CA, USA). MS spectra were recorded using automatic gain control mode with a maximum ion trap injection time of 200 ms and 3 microscans per spectrum. Tandem mass spectrometry (MS/MS) experiments were carried out by collision-induced dissociation (CID) in order to identify individual compounds in the studied samples using an isolation window of 1.5  $m/z$  units and 20-40% collision energy (manufacturer's units). Acquired data were processed using Xcalibur® 2.1.0 (Thermo Scientific) software.

### 2.3.1. Electrospray ionization.

Sample introduction (direct infusion) was carried out with the syringe pump included in the MS system using a 500  $\mu\text{L}$  Hamilton microliter syringe (Bonaduz, Switzerland) set at a constant flow of 5  $\mu\text{L}\cdot\text{min}^{-1}$ . The extracts were diluted 1:10 in a mixture of MeOH:H<sub>2</sub>O (1:1, v:v) containing 1% acetic acid and injected by direct infusion in the ESI source operating in negative polarity. MS spectra were recorded in full scan mode ( $m/z$  range 130-500). The main operating conditions for MS were as follows: sheath gas flow rate 5 (arbitrary units); capillary voltage -35 V; capillary temperature 275 °C; tube lens -110 V.

### 2.3.2. Low-temperature plasma (LTP) ambient ionization

The LTP probe used (Fig. 1) is described in detail elsewhere [26]. Briefly, it consists of a glass tube (o.d. 6.35 mm; i.d. 3.75 mm) with an internal grounded electrode (stainless steel, diameter: 1.57 mm) centered axially, and an outer electrode (copper tape) surrounding the outside of the glass tube. The wall of the glass tube serves as dielectric barrier. An alternating high voltage of *ca.* 7.2 kV at a frequency of 2.5 kHz, is applied to the outer electrode with the centre electrode grounded to generate the dielectric barrier discharge. The discharge alternating current (AC) voltage was provided by a custom-built, variable frequency, variable voltage power supply with total power consumption below 3 W. Helium flow rate (*ca.* 0.45 L·min<sup>-1</sup>) was used as discharge gas. An aliquot of oil sample (3  $\mu\text{L}$ ) was placed on the sample holder (microscope glass slide), typically 5 mm away from the LTQ inlet. The LTP probe was placed with its end 4 mm away from the surface with an angle to the sample surface of capillary *ca.* 25 degrees. To maximize sample desorption and ionization, the substrate was heated at *ca.* 110 °C using a heating gun as previously described [27, 31].

MS experiments were performed in positive and negative ionization mode, using a source voltage of 7.2 and 11 kV for each ionization mode, respectively. The main operating conditions for MS were as follows: capillary voltage and tube lens  $\pm 15$  and  $\pm 65$  V, respectively, the parameter sign was changed attending the ionization mode used, and capillary temperature 200 °C.

## 2.3.3. Paper spray ionization

Paper tips were prepared using Whatman 42 filter paper with shape and dimensions as is shown in the Fig. 2a. The paper tip was placed in an electric clamp, keeping 16 mm of the paper tip visible and located in front of the MS, with a separation *ca.* 5 mm between tip and MS inlet (Fig. 2b). A scheme of a paper spray measurement procedure is shown in Fig. 2c. An aliquot of sample (10  $\mu\text{L}$ ) is loaded onto the paper and is allowed to dry. Then, a high voltage (3-7 kV) is applied to the paper through the clamp, and an aliquot of the eluent (20  $\mu\text{L}$ ) is added onto the paper, mainly in the paper section between sample location and clamp. The eluent flows through the sample location and transport the analytes to generate ions for MS analysis [37]. A solution of methanol containing 0.1% acetic acid was used as eluent in positive ion mode experiments, while a mixture of MeOH:CHCl<sub>3</sub> (9:1, v:v) with 0.1% NH<sub>3</sub> was used for negative ionization mode.

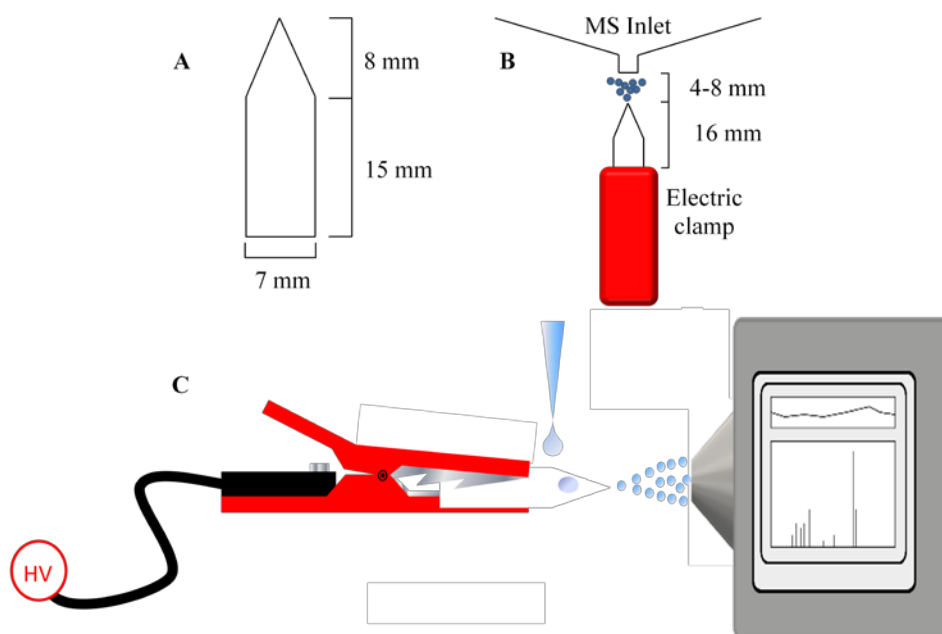

Figure 2. Schemes of shape and dimensions of paper tips (A); location and position of paper tips and MS inlet (B); and measurement by paper spray ionization.

Voltages of 6.5 and 3.5 kV were applied through the clamp for experiments in positive and negative ionization mode, respectively. The main operating conditions for MS were as follows: capillary voltage and tube lens  $\pm 35$  and  $\pm 110$  V, respectively, the parameter

sign was changed attending the ionization mode used, and capillary temperature 275 °C.

### 3. Results and discussion

#### 3.1. Direct mass spectrometry analysis of olive oil extracts using ESI, PS and LTP

Olive oil is a complex matrix constituted mainly by TAGs, but also by other minor compounds such as free fatty acids, hydrocarbons, fatty alcohols or polyphenols. Attending to the distribution of the minor compounds in olive oils, they can be classified into different categories, considering criteria such as quality, authenticity, variety or geographical origin [40,41,42]. Amongst minor compounds, phenols play a key role on the antioxidant activity of olive oil and have been widely studied. The determination of phenols in olive oil samples usually involves an extraction to separate them from the fatty matrix and for these reason, the first approach in the present work was the analysis of hydroalcoholic extracts enriched in phenolic compounds from three oils of different categories (EVOO, VOO, and LOO), prepared following a previously reported procedure [14,38].

The extracts were further diluted 1:10 in a mixture of MeOH:H<sub>2</sub>O (1:1, v:v) containing 1% acetic acid and analyzed by direct infusion electrospray mass spectrometry in negative ionization mode over the range from  $m/z$  range 130-500. No significant signals were observed above this  $m/z$  value. Figure 3 shows the ESI(-) mass spectra of samples from the three different olive oil categories: (a) EVOO, (b) VOO, and (c) LOO. Although the similar pattern was observed for the three classes, significant differences in peaks distribution, and intensities can be observed. The lower absolute intensities observed in LOO extracts are consistent with the lower amount of phenols expected in LOO compared to non-defective VOO and EVOO, although high amounts of phenols can still be found in LOO samples affected by enzymatic and other non-oxidative processes [43].

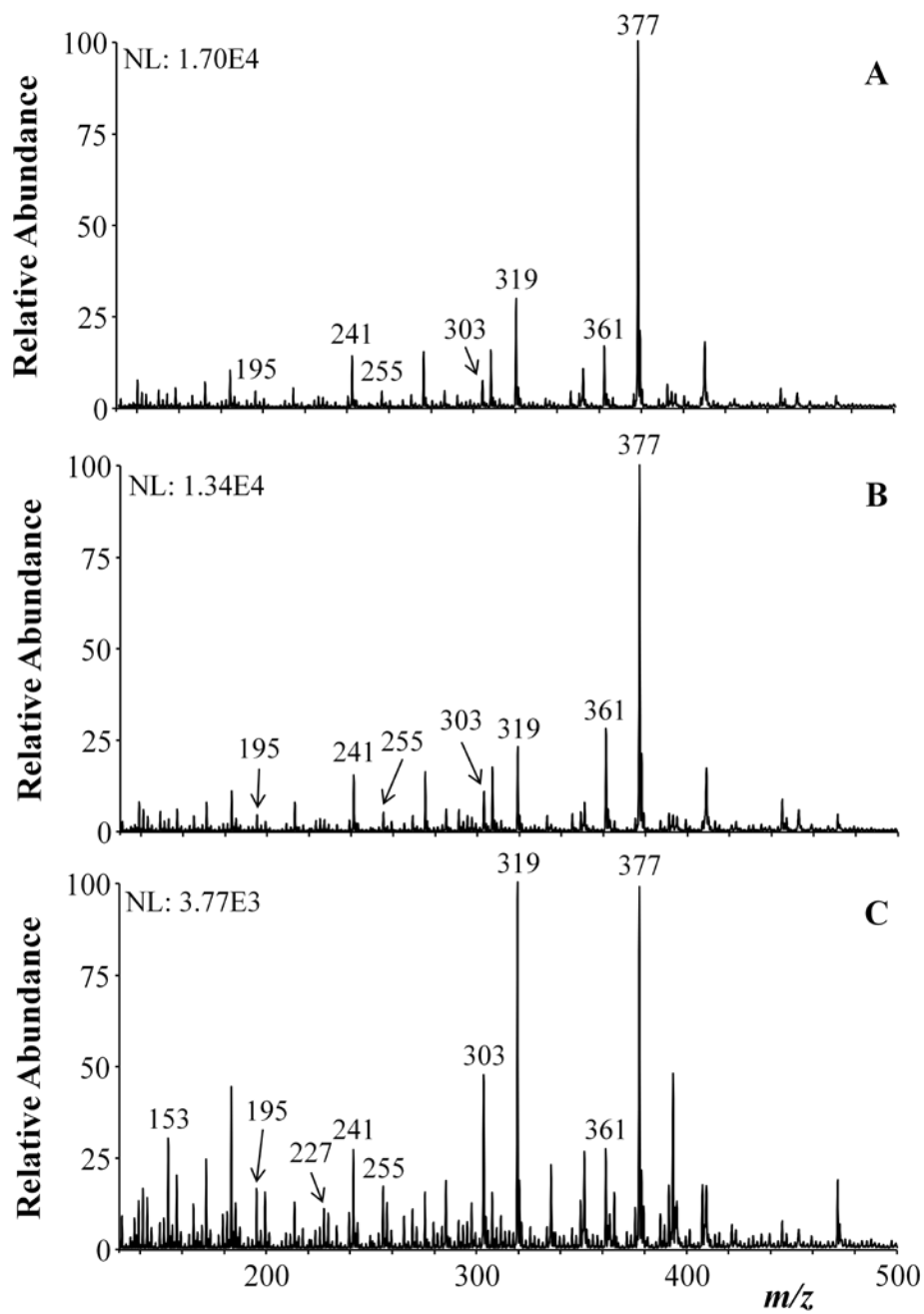

Figure 3. ESI negative ion mode mass spectra of hydroalcoholic extracts of an extra virgin olive oil (A); a virgin olive oil (B); and a lampante olive oil (C). For more details of MS acquisition conditions, see section 2.3.

Amongst the different peaks observed in the ESI spectra, the main peak at  $m/z$  377, observed for the three olive oil classes, corresponds to oleuropein aglycon, observed as  $[M-H]^-$  ion, and confirmed by MS/MS experiments, which led to ions at  $m/z$  345, 307, and 275, assigned to  $[M-H-CH_3OH]^-$ ,  $[M-H-C_4H_6O]^-$ , and  $[M-H-C_4H_6O-CH_3OH]^-$ , respectively, consistent with previous literature [44]. The ion at  $m/z$  361 corresponds to ligstroside aglycon observed as  $[M-H]^-$ . Product ion mass spectra of  $m/z$  361 led to fragment ions at  $m/z$  291 and 259, which may be assigned to the ions  $[M-H-C_4H_6O]^-$  and  $[M-H-C_4H_6O-CH_3OH]^-$ , respectively [45]. The tentative assignment corresponding to other observed peaks and their main fragment ions are summarized in Table 1.

**Table 1.** Peak assignments based on tandem mass spectrometry experiments of olive oil hydroalcoholic extracts in negative ionization mode by ESI, PS and LTP ionization sources.

Precursor ion ( $m/z$ )	Possible compound	MS <sup>2</sup> product ions ( $m/z$ )		
		ESI	PS	LTP
137	Tyrosol / <i>p</i> -hydroxybenzoic acid	119, 109, 93	119,93	119,109,93
153	Hydroxytyrosol	123, 109	123, 109	123, 109
195	Hydroxytyrosol acetate	163, 153	163, 153	-
227	Resveratrol, myristic acid	209, 183	209, 183	209, 183
241	Elenolic acid	139, 127, 95	139, 127, 95	139, 127, 95
303	Deacetoxy ligstroside aglycon	285, 179, 165	285, 179, 165	285, 275, 261
319	Deacetoxy oleuropein aglycon	301, 195	301, 195	301, 291, 275
361	Ligstroside aglycon	291, 259, 223	291, 259, 223	291, 259, 223
377	Oleuropein aglycon	345, 307, 275	345, 307, 275	345, 307,275

The obtained methanolic extracts were also studied with the paper spray assembly in the negative ion mode ( $m/z$  range 130-500). For this purpose, an aliquot (10  $\mu$ L) of the extract were deposited onto the paper triangle, and allowed to dry. Sample elution and mass analysis was undertaken by wetting the paper with a mixture of MeOH:CHCl<sub>3</sub> (9:1, v:v) with 0.1% NH<sub>3</sub> and applying a high voltage to the paper substrate. The mass spectra obtained for the three categories of oils using paper spray are shown in Figure 4. Simi-



larly to the spectra obtained by ESI source, the spectra profiles obtained for the extracts of the three oil olive classes, showed significant differences in peak distribution, although most of the ions detected are common. These results are in agreement with the classification of PS within ESI-like sources [17,18]. Thus, similar profiles in ESI and PS were expected.

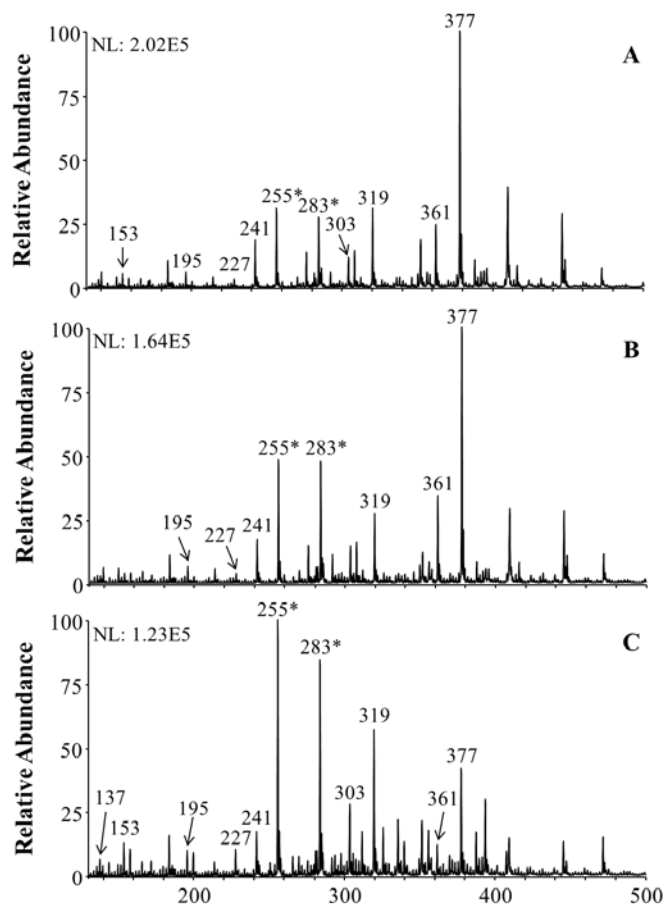

**Figure 4.** MS spectra of hydroalcoholic extracts of an extra virgin olive oil (A); a virgin olive oil (B); and a lampante olive oil (C) by PS in negative polarity. Peaks at  $m/z$  255 and 283, labeled with (\*) were also observed in blank measurements. For more details of MS working conditions, see Section 2.3.3.

Finally, the LTP ionization source was also tested in negative ion mode for the same olive extracts in the  $m/z$  130-500 range. For this purpose, an aliquot (3  $\mu\text{L}$ ) of the hydroalcoholic extracts was located in a microscope glass slide, and desorbed and ionized by the LTP probe (for procedure details see section 2.3.2.). The mass spectra profiles for the three categories of oils are shown in Figure 5. Among the tested oil classes, the

main differences are also observed in peak intensity distribution. Comparing the spectra obtained by the three ionization sources, this later source led to lower signal to noise ratios, which involves a smaller degree of information when the spectra are used for classification purposes.

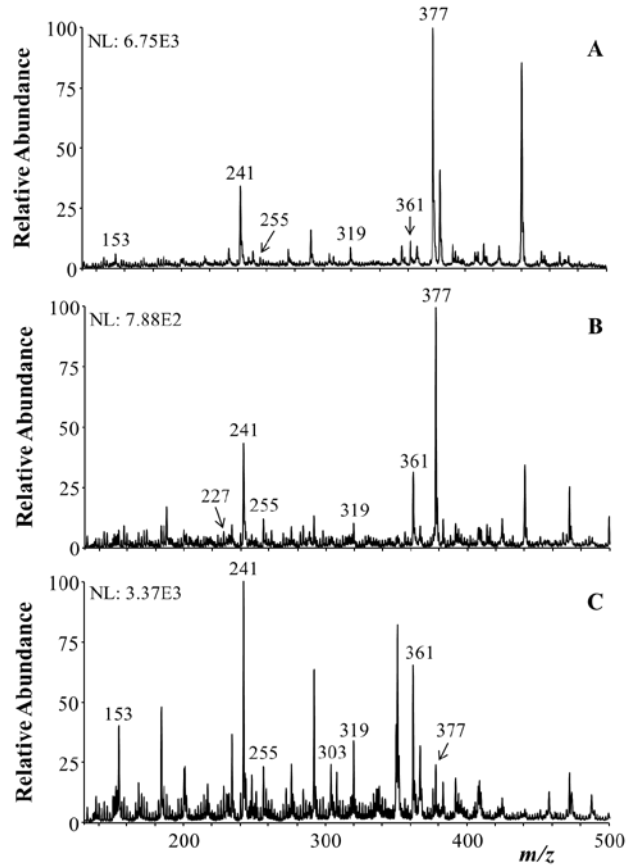

**Figure 5.** MS spectra of hydroalcoholic extracts of an extra virgin olive oil (A); a virgin olive oil (B); and a lampante olive oil (C) by LTP in negative polarity. For more details of MS working conditions, see Table 1.

### 3.2. Direct olive oil analysis by mass spectrometry using LTP and PS

The direct infusion of crude oil (even diluted) in the mass spectrometer was discarded. Preliminary experiments carried out with different mass spectrometers (TOF and ion traps) using both ESI and APCI sources with dilutions from 1:100 to 1:1000 led to carry over issues with olive oil characteristic ions tucked as background ions after a relatively low number of samples assayed and despite the high dilution factors implemented. For

this reason, this approach is not discussed in detail and no data is shown on these results.

Fig. 4a shows the mass spectrum obtained for a crude extra virgin olive oil diluted 1:1000 in  $\text{CHCl}_3$  measured in positive polarity ( $m/z$  range 130-1000) using the PS source. For this purpose, compound elution was carried out with a solution of methanol containing 0.1% of acetic acid. In the region at higher  $m/z$  values, four intense peaks ( $m/z$  767, 793, 877 and 903) appeared. The peaks at  $m/z$  877 and 903 were assigned to TAGs POO and OOO (TAG abbreviated as residual fatty acid chains bound to glycerol skeleton, P: palmitic acid, and O: oleic acid) observed as  $[\text{M}+\text{H}_2\text{O}+\text{H}]^+$  ions, whilst the peaks at  $m/z$  767 and 793 were assigned to the loss of a neutral fragment of 110 Da ( $\text{C}_8\text{H}_{14}$ ) from a residual fatty acid chain of oleic acid in the TAGs of POO and OOO, giving the ions  $[\text{POO}-\text{C}_8\text{H}_{14}+\text{H}_2\text{O}+\text{H}]^+$  and  $[\text{OOO}-\text{C}_8\text{H}_{14}+\text{H}_2\text{O}+\text{H}]^+$ , respectively. The central region of the spectrum is mainly composed by peaks corresponding to DAGs. For example, the peak at  $m/z$  639 may be assigned to the DAG composed by two residual fatty acid chains of oleic acid bound to glycerol skeleton ( $[\text{OO}+\text{H}_2\text{O}+\text{H}]^+$ ). The region at lower  $m/z$  values could be mainly composed by fatty acids or monoacylglycerols (MAGs). For example, peaks at  $m/z$  257 and 283, were assigned to palmitic and oleic acids, respectively, observed as  $[\text{M}+\text{H}]^+$ .

On the other hand, an aliquot (3  $\mu\text{L}$ ) of the same undiluted olive oil was measured by LTP source. As it is observed in Fig. 4b, the lower  $m/z$  values region presents a decrease in signal to noise ratio (comparing with PS source), where despite this, the peak assigned to the protonated oleic acid ( $m/z$  283) shows the maximum intensity. The peak at maximum intensity ( $m/z$  411) was assigned to protonated squalene ( $[\text{M}+\text{H}]^+$ ), which is a component present in olive oils in a range of 1.4 - 7.5  $\text{g}\cdot\text{kg}^{-1}$  [46]. This result agrees with the LTP source classification amongst APCI-like sources [17-20], since the low polarity for the squalene may preclude its determination by ESI-like sources, being the reason of not detected squalene with standard PS or ESI [47].

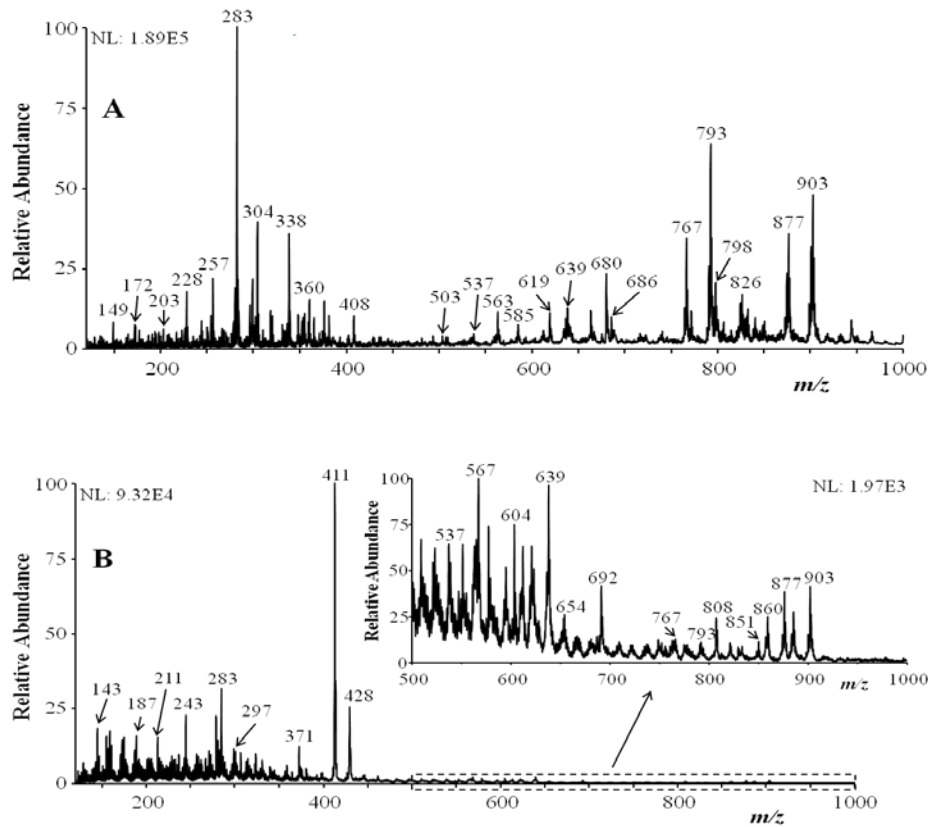

**Figure 6.** MS spectra obtained in positive ion mode ( $m/z$  range 120-1000) of an extra virgin olive oil diluted 1:1000 in  $\text{CHCl}_3$  measured by paperspray (A) and the crude olive oil measured by LTP (B). Inset in part B shows the expanded abundance axis for the mass spectrum ranged between  $m/z$  values from 500 to 1000. For more details of MS acquisition conditions, see section 2.3.

Interestingly, above  $m/z$  450, scarcely any EVOO compound was desorbed using LTP. The obtained LTP mass spectra exhibited low intensities for the species at higher  $m/z$  values (inset in Figure 6b). These results are consistent with previous studies performed using LTP, where low volatile compounds above *ca.* 500 Da are not easily desorbed and ionized [48]. This is a drawback, since most of the information related to intact TAGs is missing. On the other hand, LTP has the ability to directly interrogate bulk oil samples, without any sample treatment (even dilution).

### 3.3. Enhanced detection of squalene and TAGs using PS via silver adduct formation

Signal enhancement in paper spray ionization have been studied by the use of reactive paper spray [49,50] or paper spray substrate modification [51]. Silver ions form cationic adducts with several functional groups but demonstrate unusual affinity for olefinic compounds [52-54]. In ESI, lipidic species such as TAGs and fatty acids exhibit low ionization efficiency. The use of silver as cationization agent for TAGs determination has been reported to improve sensitivity through the formation of silver complexes [55,56]. Then, experiments in the PS source were performed adding  $\text{Ag}^+$  to the diluted sample. For this purpose, an EVOO sample was diluted 1:1000 in isopropanol, both without and with 25 mM of  $\text{AgNO}_3$ , and mass spectra were measured using the PS source.

Figure 7a shows the mass spectrum of an EVOO sample diluted 1:1000 in isopropanol. In this sample, the most intense peaks were obtained at  $m/z$  877 and 903, corresponding to POO and OOO TAGs observed as  $[\text{M}+\text{H}_2\text{O}+\text{H}]^+$  ions, and also their fragments  $[\text{POO}-\text{C}_8\text{H}_{14}+\text{H}_2\text{O}+\text{H}]^+$  ( $m/z$  767) and  $[\text{OOO}-\text{C}_8\text{H}_{14}+\text{H}_2\text{O}+\text{H}]^+$  ( $m/z$  793) were also observed. Two peaks corresponding to DAGs were also observed, peaks at  $m/z$  579 and 639, which were assigned as the ions  $[\text{PO}-\text{H}_2\text{O}+\text{H}]^+$  and  $[\text{OO}+\text{H}_2\text{O}+\text{H}]^+$ , respectively.

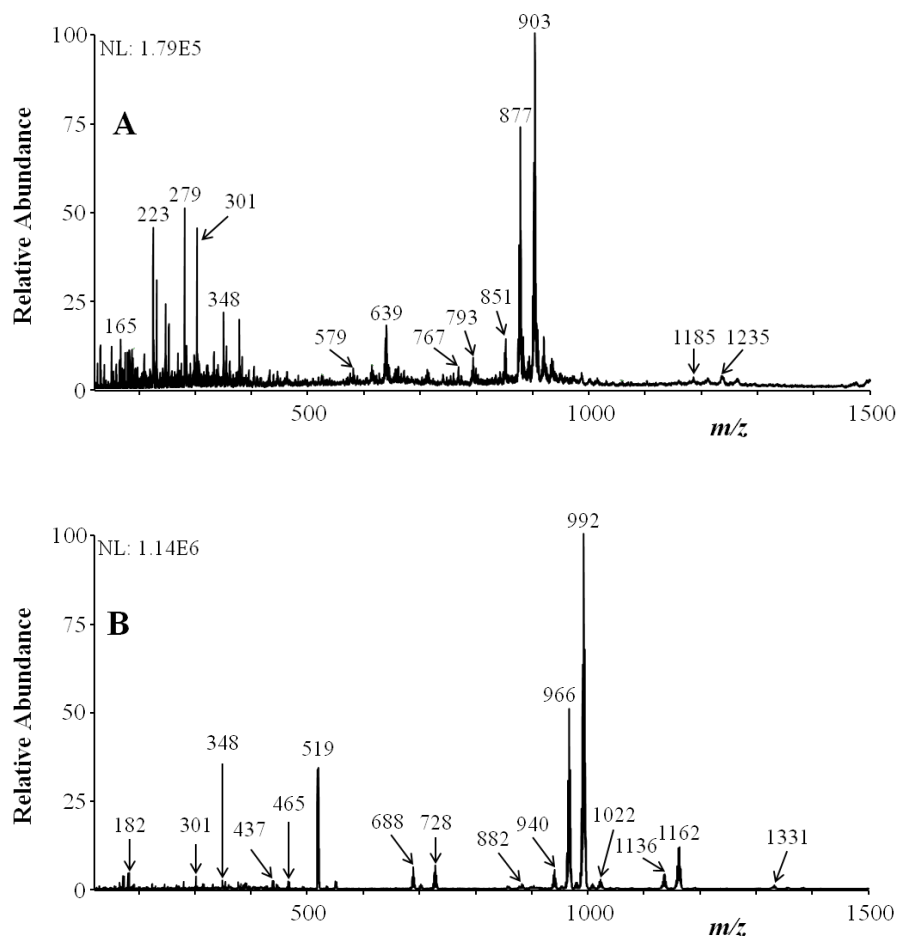

**Figure 5.** Paperspray mass spectra obtained in positive ion mode ( $m/z$  range 120-1500) of an extra virgin olive oil diluted 1:1000 in isopropanol (A), and via silver adduct formation with 25 mM of  $\text{AgNO}_3$  (B). For more details of MS acquisition conditions, see section 2.3.

On the other hand, when  $\text{AgNO}_3$  was added to the sample the obtained mass spectrum changed (Figure 7b). An increase in peaks intensity, and signal to noise ratio, were observed. In addition, the main peaks observed showed a shift in the  $m/z$  values. The maximum peak observed ( $m/z$  992), should be assigned to  $[\text{OOO}+\text{Ag}]^+$ . The detailed assignment of the different ions detected with PS using silver nitrate and the comparison with standard PS is provided in Table 1. Notably, squalene, not detected using ESI or regular PS, was effectively detected via the formation of silver adducts ( $m/z$  519,

[M+Ag]<sup>+</sup>), thus extending the ionization coverage of paper spray not only for polar ESI-amenable compounds but also to other olefinic species with double bonds or aromatic systems, abundant in edible oils. The use of this chemical derivatization also provides enhanced selectivity.

#### 4. Conclusions

In this work, two different ambient mass spectrometric methods (LTP and PS) were proposed and compared for the direct olive oil analysis for quality control purposes. The use of ESI source is limited for direct analysis of oils since the lipidic matrix introduced into the mass spectrometer (even diluted) originates critical carry-over in the MS system. Then, direct infusion experiments were done using hydroalcoholic extracts enriched with the polar fraction of the oil. On the other hand, the studied ambient ionization sources (LTP and PS) keep the carry-over as low as possible, since only a fraction of the samples is desorbed, ionized and entered in the MS system. In addition, these sources allow the analysis of olive oil without (raw oil) or after a simple dilution.

Significant differences were found in the information that can be extracted from both LTP and PS-MS. Above an  $m/z$  threshold (*ca.* 500), scarcely any olive oil compound were desorbed using LTP. This fact involves the loss of most of the information related to intact TAGs along with possible MAGs and DAGs. Therefore, paper spray in this aspect outperformed LTP, as a higher range of species is ionized and can be used for sample classification. In addition, adduct formation with Ag<sup>+</sup> ions by  $\pi$ - $\pi$  interactions between Ag<sup>+</sup> and the double bonds from the fatty acid chains offers the possibility of analysis based on unsaturated compounds presents in olive oil, which can provide enhanced differences of the mass spectra of vegetable oils with different degree or percentage of unsaturated fatty acids in their composition.

## **Acknowledgements**

The authors acknowledge funding from Junta Andalucía through projects Ref. AGR-6066 and FQM-2242 and from MINECO (CTQ2015-71321P). F.J.L.-O. acknowledges a PhD student scholarship from MINECO (Ref. BES-2013-064014). We also acknowledge Alexander Schütz, Sebastian Brandt and Prof. Joachim Franzke (Leibniz-Institut für Analytische Wissenschaften –ISAS e.V., Dortmund, Germany) for their helpful comments and assistance. Finally, the Instituto Andaluz de Investigación y Formación Agraria, Pesquera, Alimentaria y de la Producción Ecológica, Estación de Olivicultura y Elaiotecnica CIFA 'Venta del Llano' (Mengíbar, Spain) is acknowledged for kindly providing the olive oil samples.



## References

- [1] D. Mozaffarian, Mediterranean diet for primary prevention of cardiovascular disease, *New Engl. J. Med.* 369 (2013) 673 - 674.
- [2] D. Boskou, *Olive oil chemistry and technology book*, Second edition, Academic Press and AOCS Press, 2006.
- [3] S. Armenta, S. Garrigues, M. De la Guardia, Green analytical chemistry, *Trends. Anal. Chem.* 27 (2008) 497 - 566.
- [4] A. Galuszka, Z. Migaszewski, J. Namiesnik, The 12 principles of Green analytical chemistry and the SIGNIFICANCE mnemonic of Green analytical practices, *Trends Anal. Chem.* 50 (2013) 78 - 84.
- [5] K.I. Poulli, G.A. Mousdis, C.A. Georgiou, Synchronous fluorescence spectroscopy for quantitative determination of virgin olive oil adulteration with sunflower oil, *Anal. Bioanal. Chem.* 386 (2006) 1571 - 1575.
- [6] E. López Diez, G. Bianchi, R.J. Goodacre, Rapid quantitative assessment of the adulteration of virgin olive oils with hazelnut oils using Raman spectroscopy and chemometrics, *J. Agric. Food Chem.* 51 (2003) 6145 - 6150.
- [7] A.A. Christy, S. Kasemsumran, Y. Du, Y. Ozaki, The detection and quantification of adulteration in olive oil by near-infrared spectroscopy and chemometrics, *Anal. Sci.* 20 (2004) 935 - 940.
- [8] N. Vlachos, Y. Skopelitis, M. Psaroudaki, V. Konstantinidou, A. Chatzilazarou, E. Tegou, Applications of Fourier transform-infrared spectroscopy to edible oils. *Anal. Chim. Acta* 573 (2006) 459 - 465.
- [9] G. Fragaki, A. Spyros, G. Siragakis, E. Salinaras, P. Dais, Detection of extra virgin olive oil adulteration with lampante olive oil and refined olive oil using nuclear magnetic resonance spectroscopy and multivariate statistical analysis, *J. Agr. Food Chem.* 53 (2005) 2810 - 2816.
- [10] B. Gilbert-López, Z.L. Valencia-Reyes, V.M. Yufra-Picardo, J.F. García-Reyes, N. Ramos-Martos, A. Molina-Díaz. Determination of polyphenols in commercial extra virgin olive oils from different origins (Mediterranean and South American countries) by liquid chromatography-electrospray time-of-flight mass spectrometry, *Food Anal. Methods* 7 (2014) 1824 - 1833.

- [11] M.I. Alarcón Flores, R. Romero-González, A. Garrido Frenich, J.L. Martínez Vidal, Analysis of phenolic compounds in olive oil by solid-phase extraction and ultra high performance liquid chromatography-tandem mass spectrometry, *Food Chem.* 134 (2012) 2465 - 2472.
- [12] M. Becerra-Herrera, M. Sánchez-Astudillo, R. Beltrán, A. Sayago, Determination of phenolic compounds in olive oil: New method based on liquid-liquid micro extraction and ultra high performance liquid chromatography-triple-quadrupole mass spectrometry, *LWT-Food Sci. Technol.* 57 (2014) 49 - 57.
- [13] I. Marcos Lorenzo, J.L. Pérez Pavón, M.E. Fernández Laespada, C. García Pinto, B. Moreno Cordero, L.R. Henriques, M.F. Peres, M.P. Simões, P.S. Lopes, Application of headspace-mass spectrometry for differentiating sources of olive oil, *Anal. Bioanal. Chem.* 374 (2002) 1205 - 1211.
- [14] D. Zabarás, M.H. Gordon, Detection of pressed hazelnut oil in olive oil by analysis of polar components: improvement and validation of the method, *Food Chem.* 84 (2004) 475 - 483.
- [15] R. Goodacre, S. Vaidyanathan, G. Bianchi, D.B. Kell, Metabolic profiling using direct infusion electrospray ionisation mass spectrometry for the characterisation of olive oils, *Analyst* 127 (2002) 1457 - 1462.
- [16] J.L. Gómez-Ariza, A. Arias-Borrego, T. García-Barrera, R. Beltrán, Comparative study of electrospray and photospray ionization sources coupled to quadrupole time-of-flight mass spectrometer for olive oil authentication, *Talanta* 70 (2006) 859 - 869.
- [17] A. Venter, M. Nefliu, R.G. Cooks, Ambient desorption ionization mass spectrometry, *TrAC Trends Anal. Chem.* 27 (2008) 284 - 290.
- [18] C.W. Klampfl, M. Himmelsbach, Direct ionization methods in mass spectrometry: An overview, *Anal. Chim. Acta* 890 (2015) 44 - 59.
- [19] J. Chen, F. Tang, C. Guo, S. Zhang, X. Zhang, Plasma-based ambient mass spectrometry: a step forward to practical applications, *Anal. Methods* 9 (2017) 4908 - 4923.
- [20] T. J. Kauppila, R. Kostianen, Ambient mass spectrometry in the analysis of compounds of low polarity, *Anal. Methods* 7 (2017) 4936 - 4953.
- [21] R.B. Cody, J.A. Laramée, H.D. Durst, Versatile new ion source for the analysis of materials in open air under ambient conditions, *Anal. Chem.* 77 (2005) 2297 - 2302.

- [22] Z. Takáts, I. Cotte-Rodriguez, N. Talaty, H.W. Chen, R.G. Cooks, Direct, trace level detection of explosives on ambient surfaces by desorption electrospray ionization mass spectrometry, *Chem. Commun.* 15 (2005) 1950 - 1952.
- [23] F.J. Andrade, J.T. Shelley, W.C. Wetzel, M.R. Webb, G. Gámez, S.J. Ray, G.M. Hieftje, Atmospheric pressure glow discharge desorption mass spectrometry for rapid screening of pesticides in food, *Rapid Commun. Mass Sp.* 80 (2008) 2791 - 2798.
- [24] L.V. Ratcliffe, J.M. Rutten, D.A. Barrett, T. Whitmore, D. Seymour, C. Greenwood, Y. Aranda-Gonzalvo, S. Robinson, M. McCoustra, Surface analysis under ambient conditions using plasma-assisted desorption/ionization mass spectrometry. *Anal. Chem.* 79 (2007) 6094 - 6101.
- [25] N. Na, M. Zhao, S. Zhang, C. Yang, X. Zhang, Development of a dielectric barrier discharge ion source for ambient mass spectrometry. *J. Am. Soc. Mass Spectrom.* 18 (2007) 1859 - 1862.
- [26] J.D. Harper, N.A. Charipar, C.C. Mulligan, X. Zhang, R.G. Cooks, Z. Ouyang, Low-temperature plasma probe for ambient desorption ionization, *Anal. Chem.* 80 (2008) 9097 - 9104.
- [27] G. Huang, Z. Ouyang, R.G. Cooks, High-throughput trace melamine analysis in complex mixtures, *Chem. Commun.* 5 (2009) 556 - 558.
- [28] Y. Zhou, Z. Wu, C. Li, N. Wang, X. Zhang, H. Chen, S. Xiao, Coupling neutral desorption sampling to dielectric barrier discharge ionization mass spectrometry for direct oil analysis, *Anal. Methods* 6 (2014) 1538 - 1544.
- [29] A.M.A.P. Fernandes, G.D. Fernandes, R.C. Simas, D. Barrera-Arellano, M.N. Eberlina, R.M. Alberici, Quantitation of triacylglycerols in vegetable oils and fats by easy ambient sonic-spray ionization mass spectrometry. *Anal. Methods* 5 (2013) 6969 - 6975.
- [30] M.F. Riccio, A.C.H.F. Sawaya, P.V. Abdelnur, S.A. Saraiva, R. Haddad, M.N. Eberlin, R.R. Catharino, Easy ambient sonic-spray ionization mass spectrometric of olive oils: Quality control and certification of geographical origin, *Anal. Lett.* 44 (2011) 1489 - 1497.
- [31] R.C. Simas, R.R. Catharino, I.B.S. Cunha, E.C. Cabral, D. Barrera-Arellano, M.N. Eberlina, R.M. Alberici, Instantaneous characterization of vegetable oils via TAG and FFA profiles by easy ambient sonic-spray ionization mass spectrometry, *Analyst* 135 (2010) 738 - 744.

- [32] J.F. García-Reyes, F. Mazzoti, J.D. Harper, N.A. Charipar, S. Oradu, Z. Ouyang, G. Sindona, R.G. Cooks, Direct olive oil analysis by low-temperature plasma (LTP) ambient ionization mass spectrometry. *Rapid Commun. Mass Sp.* 23 (2009) 3057 - 3062.
- [33] L. Vaclavik, B. Belkova, Z. Reblova, K. Riddellova, J. Hajslova, Rapid monitoring of heat-accelerated reactions in vegetable oils using direct analysis in real time ionization coupled with high resolution mass spectrometry, *Food Chem.* 138 (2013) 2312 - 2320.
- [34] F. Mazzotti, L. Di Donna, D. Taverna, M. Nardi, D. Aiello, A. Napoli, G. Sindona, Evaluation of dialdehydic anti-inflammatory active principles in extra-virgin olive oil by reactive paper spray mass spectrometry, *Int. J. Mass Spectrom.* 352 (2013) 87 - 91.
- [35] L. Vaclavik, T. Cajka, V. Hrbek, J. Hajslova, Ambient mass spectrometry employing direct analysis in real time (DART) ion source for olive oil quality and authenticity assessment, *Anal. Chim. Acta* 645 (2009) 56 - 63.
- [36] R. Haddad, R. Sparrapan, T. Kotiaho, M.N. Eberlin, Easy ambient sonic-spray ionization-membrane interface mass spectrometry for direct analysis of solution constituents, *Anal. Chem.* 80 (2008) 898 - 903.
- [37] J. Liu, H. Wang, N.E. Manicke, J.M. Lin, R.G. Cooks, Z. Ouyang, Development, characterization, and application of paper spray ionization, *Anal. Chem.* 82 (2010) 2463 - 2471.
- [38] A. Bajoub, A. Carrasco-Pancorbo, E.A. Ajal, N. Ouazzani, A. Fernández-Gutiérrez, Potential of LC-MS phenolic profiling combined with multivariate analysis as an approach for the determination of the geographical origin of north Moroccan virgin olive oils, *Food Chem.* 166 (2015) 292 - 300.
- [39] S.H. Kim, H.J. Jang, J.H. Park, H.J. Lee, J. Kim, Y.H. Yim, D.B. Kim, S. Yoon, Comparison of desorption enhancement methods in the low temperature plasma ionization mass spectrometry for detecting fatty acids in *Drosophila*, *Curr. Appl. Phys.* 17 (2017) 1120 - 1126.
- [40] D.L. García-González, R. Aparicio, Research in olive oil: Challenges for the near future, *J. Agric. Food Chem.* 58 (2010) 12569 - 12577.
- [41] R. Aparicio, M.T. Morales, R. Aparicio-Ruiz, N. Tena, D.L. García-González, Authenticity of olive oil: Mapping and comparing official methods and promising alternatives, *Food Res. Int.* 54 (2013) 2025 - 2038.
- [42] Trade standard applying to olive oils and olive-pomace oils, International Olive Council, COI/T.15/NC No 3/Rev. 11 (July 2016), <http://www.internationaloliveoil.org/>.

- [43] R. Aparicio-Ruiz, D.L. García-González, C. Oliver-Pozo, N. Tena, M.T. Morales, R. Aparicio, Phenolic profile of virgin olive oils with and without sensory defects: Oils with non-oxidative defects exhibit a considerable concentration of phenols. *Eur. J. Lipid Sci. Technol.* 118 (2016) 299 – 307.
- [44] S. Fu, D. Arráez-Román, J.A. Menéndez, A. Segura-Carretero, A. Fernández-Gutiérrez, Characterization of isomers of oleuropein aglycon in olive oils by rapid-resolution liquid chromatography coupled to electrospray time-of-flight and ion trap tandem mass spectrometry, *Rapid Commun. Mass Spectrom.* 23 (2009) 51 - 59.
- [45] S. Fu, A. Segura-Carretero, D. Arráez-Román, J.A. Menéndez, A. De La Torre, A. Fernández-Gutiérrez, Tentative characterization of novel phenolic compounds in extra virgin olive oils by rapid-resolution liquid chromatography coupled with mass spectrometry, *J. Agric. Food Chem.* 57 (2009) 11140 – 11147.
- [46] A. Salvo, G.L. La Torre, A. Rotondo, V. Mangano, K.E. Casale, V. Pellizzeri, M.L. Clodoveo, F. Corbo, N. Cicero, G. Dugo, Determination of squalene in organic extra virgin olive oils (EVOOs) by UPLC/PDA using a single-step SPE sample preparation, *Food Anal. Methods* 10 (2017) 1377 - 1385.
- [47] Z. Jin, S. Daiya, H. I. Kenttämä, Characterization of nonpolar lipids and selected steroids by using laser-induced acoustic desorption/chemical ionization, atmospheric pressure chemical ionization, and electrospray ionization mass spectrometry, *Int. J. Mass Spectrom.* 301 (2011) 234 - 239.
- [48] A.C. Engelhard. Characteristics of low-temperature plasma ionization for ambient mass spectrometry compared to electrospray ionization and atmospheric pressure chemical ionization. *Anal. Chem.* 84 (2012) 10657 - 10664.
- [49] S. Bag, P.I. Hendricks, J.C. Reynolds, R.G. Cooks, Biogenic aldehyde determination by reactive paper spray ionization mass spectrometry, *Anal. Chim. Acta* 860 (2015) 37 - 42.
- [50] A. Schedl, T. Zweckmair, F. Kikul, U. Henniges, T. Rosenau, A. Potthast, Aging of paper – Ultra-fast quantification of 2,5-dihydroxyacetophenone, as a key chromophore in cellulose, by reactive paper spray-mass spectrometry, *Talanta* 167 (2017) 672 - 680.
- [51] J. Liu, Y. Hea, S. Chen, M. Ma, S. Yao, B. Chen, New urea-modified paper substrate for enhanced analytical performance of negative ion mode paper spray mass spectrometry, *Talanta* 166 (2017) 306 - 314.

- [52] A.U. Jackson, T. Shum, E. Sokol, A. Dill, R.G. Cooks, Enhanced detection of olefins using ambient ionization mass spectrometry: Ag<sup>+</sup> adducts of biologically relevant alkenes, *Anal. Bioanal. Chem.* 399 (2011) 367 - 376.
- [53] V. Pirro, S.C. Guffey, M.S. Sepúlveda, C.T. Mahapatra, C.R. Ferreira, A.K. Jarmusch, R.G. Cooks, Lipid dynamics in zebrafish embryonic development observed by DESI-MS imaging and nanoelectrospray-MS, *Mol. Biosyst.* 12 (2016) 2069 - 2079.
- [54] K.D. Swanson, S.E. Spencer, G.L. Glish, Metal cationization extractive electrospray ionization mass spectrometry of compounds containing multiple oxygens. *J. Am. Soc. Mass Spectrom.* 28 (2017) 1030 - 1035.
- [55] N.L. Lévêque, S. Héron, A. Tchaplá, Regioisomer characterization of triacylglycerols by non-aqueous reversed-phase liquid chromatography/electrospray ionization mass spectrometry using silver nitrate as a postcolumn reagent, *J. Mass. Spectrom.* 45 (2010) 284 - 296.
- [56] A. Acheampong, N. Leveque, A. Tchaplá, S. Heron, Simple complementary liquid chromatography and mass spectrometry approaches for the characterization of triacylglycerols in *Pinus koraiensis* seed oil, *Journal of Chromatography A*, 1218 (2011) 5087–5100.



## Artículo 5: Overcoming matrix effects and sodium adduct formation in LC-MS using Dielectric Barrier Discharge Ionization

### Resumen

En el último artículo de esta tesis, se ha desarrollado un método para la determinación de un amplio rango de plaguicidas (unos 80) de muy distinta naturaleza, siendo la clave de este método el uso de una fuente de ionización de descarga por barrera dieléctrica (DBDI). Aunque la ionización por electrospray (ESI) sigue siendo la fuente de ionización principal para LC-MS, presenta dos limitaciones principales: la aparición de efecto matriz y la limitada cobertura de ionización hacia compuestos no polares, para los cuales se suele recurrir a la ionización química a presión atmosférica (APCI). En los últimos años, la DBDI se ha revelado como un método versátil de ionización para diferentes aplicaciones. En este trabajo, se ha llevado a cabo una evaluación exhaustiva de DBDI como interfaz de ionización para LC-MS, que revela ventajas atractivas sobre ESI y APCI. La DBDI no sólo permitió la ionización de compuestos que hasta ahora sólo se determinaban en GC-MS como los plaguicidas organoclorados, sino que ofrecía un rendimiento competitivo en términos de sensibilidad cuando se contrastaba con la fuente ESI en aquellos compuestos que se ionizan por esta fuente. A diferencia de ESI, el proceso de ionización DBDI tiene lugar en fase gaseosa como en APCI, por lo que el método se ve menos afectado por fenómenos superficiales en las gotas del aerosol formado en ESI, que son los principales responsables de la supresión iónica en esta fuente. Los datos obtenidos revelaron valores de efecto matriz insignificantes (<10% de supresión) para la mayoría de los compuestos estudiados en las tres matrices estudiadas: aceite de oliva, agua residual y naranja. Debe destacarse también la ausencia de formación de aductos de sodio en modo de ionización positivo, con la consiguiente ventaja que ello supone frente a la fuente ESI, donde este fenómeno es común. En general, tanto la sensibilidad como los límites medios de cuantificación para DBDI fueron similares a los obtenidos por ESI y mejores que APCI, además de poseer un mayor rango de aplicación al poder ionizar compuestos organoclorados.



# Overcoming matrix effects and sodium adduct formation in LC-MS using Dielectric Barrier Discharge Ionization

(Submitted to Analytical Chemistry)

Felipe J. Lara-Ortega<sup>1,2</sup>, José Robles-Molina<sup>2</sup>, Sebastian Brandt<sup>1</sup>, Alexander Schütz<sup>1</sup>, Bienvenida Gilbert-López<sup>2</sup>, Antonio Molina-Díaz<sup>2,3</sup>, Juan F. García-Reyes<sup>2\*</sup> and Joachim Franzke<sup>1\*\*</sup>

<sup>1</sup>*Leibniz-Institut für Analytische Wissenschaften –ISAS e.V., Dortmund, Germany*

<sup>2</sup>*Analytical Chemistry Research Group, Department of Physical and Analytical Chemistry, University of Jaén, 23071 Jaén (Spain)*

<sup>3</sup>*Center for Advanced Studies in Olives Grove and Olive Oils (CEAOAO), Science and Technology park GEOLIT, E-23620 Mengíbar, Spain*

\*Corresponding author:

\*\*Prof. Joachim Franzke Leibniz-Institut für Analytische Wissenschaften-ISAS –e.V., Bunsen-Kirchoff, 11, 44139 Dortmund, Germany. Tel.: (+49) 2311392174. Fax: (+49) 2311392200 E-mail: [joachim.franzke@isas.de](mailto:joachim.franzke@isas.de)

\*Prof. Juan F. García-Reyes, Analytical Chemistry Research Group, University of Jaén, 23071 Jaén, Spain. Tel.: (+34) 953 213040; Fax: (+34) 953 212940. E-mail: [amolina@ujaen.es](mailto:amolina@ujaen.es)

**Abstract**

Although electrospray ionization (ESI) remains the gold standard ionization source for LC-MS, it exhibits two main limitations: the occurrence of matrix effects and the limited ionization coverage towards nonpolar compounds. Dielectric barrier discharge ionization (DBDI) has gained attraction in recent years as a versatile ionization method in different applications and formats. Here, we report a thorough evaluation of DBDI as ionization interface for LC-MS, which reveals attractive advantages over ESI and APCI provided its singular ionization mechanism versatility. A suite of ca. 80 pesticides across a wide range of physicochemical properties were selected and the results were compared with both electrospray and atmospheric pressure chemical ionization (APCI) sources. Not only DBDI was able to ionize compounds only amenable so far by GC-MS (eg. organochlorine species), but also offered a competitive performance in terms of sensitivity when contrasted with the commercial electrospray ionization source under equivalent conditions. Unlike ESI, DBDI mechanism occurs in the gas-phase, so the method is less affected by liquid-phase surface phenomena that yield ion suppression in ESI. Data collected in the positive ion mode revealed negligible matrix effect values (<10% suppression) for most of the studied compounds in different complex matrix extracts such as wastewater, orange or olive oil. This is also consistent with the absence of adduct formation whereas with ESI source, Na adduct formation is quite common with these species. In general, both sensitivity and average limits of quantitation for DBDI were similar to those obtained by ESI and better than APCI. Results showed that analyte coverage with DBDI is enhanced with respect to ESI and APCI sources being able to effectively analyze organochlorine compounds.

## **Introduction**

The combination of liquid chromatography with mass spectrometry (LC-MS) by means of atmospheric pressure ionization interfaces (mainly electrospray) is mainstream for a plethora of applications within trace quantitative organic analysis. Perhaps, the main issues associated to this approach are the occurrence of matrix effects and the restricted ionization coverage towards nonpolar species offered by electrospray ionization, which limits the versatility of the technique [1]. Matrix effects represent a major concern in small-molecule trace analysis as they severely compromise not only quantitative performance but also method reproducibility [2,3]. A matrix effect is considered to be an (unexpected) suppression or enhancement of the analyte response due to co-eluting matrix constituents [4,5]. Matrix effects strongly depend on the nature of the analytes and on the properties of coeluting compounds [6]. The fundamental basics involved in this effect are diverse, although most explanations are linked to liquid-phase and differential surface activity of coeluting molecules [7].

Several approaches have been attempted to prevent matrix effects. The most obvious one is additional sample workup [8], leading to the selective removal of potential coeluting interferences. As an alternative, sample or extract dilution [9] is applied if the expected fit-for-purpose concentrations meet the overall sensitivity of the method. Different strategies related to the use of isotopically labelled (internal) standards have been also proposed to diminish the effects of ionization suppression [10,11], although their efficiency and widespread use are limited by the lack of standards, their cost and also to isotope effects which leads to retention time shifts so that ionization suppression or enhancement is not accurately compensated [12]. Alternative ionization sources have been also proposed to overcome the problems associated to electrospray ionization signal suppression or enhancement [13,14]. In the past, the use of atmospheric pressure chemical ionization and electron impact ionization methods has been proposed to minimize matrix effects [15], based on the fact that ionization mechanism occurs after solvent elimination. Thus, no surface-related effects are expected with these alternative ionization methods.

One of the fastest growing topics in mass spectrometry is the development of ambient ionization methods, so that both sampling and ionization steps are undertaken without the restrictions of either MALDI or electrospray ionization. Amongst these methods, plasma-based ambient ionization methods [16,17] are based on reactant species capable of effectively ionizing analytes of interest. These species are generated using noble gases or with the surrounding environment, after the application of DC or AC voltages. Dielectric barrier discharge ionization (DBDI) has gained attraction in recent years as a versatile ionization method available in different formats (viz. ambient ionization probes [18,19], GC-MS [20], LC-MS [21,22] or CE-MS [23] interfaces). Since its first description it has become very popular for applications in analytical science because of its outstanding features, including flexibility and simplicity of setup, low energy consumption, good portability, and high chemical activity. Many applications have been addressed by DBDI including ambient mass spectrometry imaging [24], environmental analysis, biological, pharmaceutical analysis and food safety [25-27]. DBDI uses low-temperature plasmas at atmospheric pressure to generate ions. The DBD is typically formed between two electrodes, with at least one dielectric layer which separates the electrode from the plasma.

DBDI was also proven to be an interesting ionization technique for liquid chromatography mass spectrometry coupling (LC-MS) [21]. The DBDI probe can be implemented into a commercial API (atmospheric pressure ionization) source so that the LC eluent was nebulized and vaporized in the same manner as for atmospheric pressure chemical ionization (APCI). These features lead to enhanced analyte coverage compared to commercially available LC-MS sources as was reported [21,28] to measure non-polar non-ESI-amenable compounds such as polycyclic aromatic hydrocarbons (PAHs) and organochlorine compounds. Follow-up fundamental studies on the AC waveform applied [29,30] have led to significant progress and further improve the performance of DBDI plasmajet towards soft ionization of small molecules, with respect to first reports [21,28,31].

Here, we report a thorough evaluation of DBDI as ionization interface for LC-MS, which reveals attractive advantages over ESI and APCI, due to its singular ionization mechanisms versatility. A suite of ca. 80 pesticides across a wide range of physicochemical properties were selected and the results were compared with both electrospray and APCI sources. Matrix effects, analyte coverage, sensitivity and salt adduct formation were evaluated with the three different approaches.

## **Experimental section**

**Chemical and reagents.** Pesticide analytical standards were purchased from Fluka, Pestanal® quality (Madrid, Spain) and Sigma-Aldrich (Steinheim, Germany). Individual stock solutions of the studied compounds (ca. 500 µg mL<sup>-1</sup> each) were prepared in methanol, acetonitrile and mixtures of acetone-acetonitrile (25:75) and stored at -20 °C. HPLC-grade methanol (MeOH), acetone, acetonitrile (ACN), formic acid (HCOOH), ammonium formate, magnesium sulfate anhydrous (MgSO<sub>4</sub>), sodium acetate (AcNa) and sodium chloride were also purchased from Sigma-Aldrich (Steinheim, Germany). Primary-secondary amine (PSA) and EMR lipid removal sorbents were obtained from Agilent Technologies (Santa Clara, CA, USA). A Milli-Q Plus ultra-pure water system from Millipore (Milford, MA, USA) was used throughout the study. Working solutions were prepared by appropriate dilution of the stock solutions with MeOH and water to match the initial mobile phase composition of the LC gradients used.

**Pesticide selected and matrices tested.** 80 representative multiclass analytes covering the main classes of pesticides (herbicides, fungicides, insecticides, acaricides), pesticide breakdown products and reagents in their production (such as pentachlorobenzene) were selected to evaluate the proposed study (Table 1 and 2, Annex). The selection was made on the basis of their physicochemical properties that make them GC and/or LC amenable.

### Sample treatment.

**Procedure 1 (oranges): liquid-liquid partitioning with acetonitrile following by a dispersive solid-phase extraction clean-up (modified QuEChERS for non-fatty matrices).** Orange (high water and acidic compounds contents) were used as model of non-fatty vegetable matrices. A representative 10 g portion of homogenized sample was weighed in a 50-mL plastic centrifuge tube and mixed with 10 mL of MeCN, being the tubes vigorously shaken for 1 minute. Then, 1 g of NaCl and 4 g of MgSO<sub>4</sub> anhydrous were added and the tubes were shaken again to prevent coagulation of MgSO<sub>4</sub>. The extracts were centrifuged (3700 rpm, 1376 g) for 3 minutes. A 5-mL aliquot of supernatants (organic phase) were taken with a pipette and transferred to 15 mL centrifuge tubes containing 250 mg of PSA and 750 mg of MgSO<sub>4</sub> anhydrous that were energetically shaken for 30 seconds. The extracts were centrifuged again (3700 rpm, 1376 g) for 3 minutes. A 0.2-mL aliquot of this final extract was evaporated under a gentle nitrogen stream using a Turbo Vap LV from Zymark (Hopkinton, MA), with a water bath temperature of 37 °C and a N<sub>2</sub> pressure of 15 psi. This residue was re-dissolved with 0.100 mL of MeOH and 0.900 mL water, and filtered through a 0.45µm PTFE filter, being collected in a 2-mL glass vial.

**Procedure 2 (olive oil): liquid-liquid partitioning with acetonitrile following by a dispersive solid-phase extraction clean-up (modified QuEChERS for fatty matrices).** The initial extraction step was also analogous to the official method AOAC.2007.01 (10 g of sample + 10 mL MeCN + 4 g MgSO<sub>4</sub> and 1 g NaCl). First of all, 1 g of EMR sorbent was activated with 5 mL of H<sub>2</sub>O Milli-Q prior to use, added in the centrifuge tube containing the sorbent. Then, 5 mL of acetonitrile extract from sample partitioning were added, being the tube shaken for 1 min and then centrifuged at 5000 rpm for 5 min. After this step, 5 mL of the obtained supernatant were transferred with a second centrifuge tube, which contained 1.6 g of MgSO<sub>4</sub> and 0.4 g of NaCl, being shaken and centrifuged. A 1:10 dilution of the organic phase with H<sub>2</sub>O Milli-Q was performed so that the final extract matches the mobile phase composition. No filtration was required except in the case of olive extract.

**Procedure 3 (wastewater): solid-phase extraction (wastewater samples).** 60 mL of effluent wastewater sample (pH 7) were passed through an Oasis HLB SPE cartridge (200 mg) previously conditioned with 4 mL of methanol and 8 mL of Milli-Q water. After loading the sample, the elution was performed with two aliquots of 4 mL of MeOH. The extract collected was evaporated under a gentle nitrogen stream using a Turbo Vap LV from Zymark (Hopkinton, MA), with a water bath temperature of 37 °C and a N<sub>2</sub> pressure of 15 psi. This residue was re-dissolved with 0.100 mL of MeOH and 0.900 mL water, being collected in a 2-mL glass vial, and achieving a final preconcentration factor of 60:1.

In summary, the orange extract was obtained by the so-called “buffered QuEChERS” described elsewhere [32] and was diluted five times with initial mobile-phase composition. To obtain effluent wastewater matrix extracts a solid phase extraction (SPE) procedure with Oasis HLB™ SPE cartridges (200 mg, 6 mL, Waters (Milford, MA, USA)) described elsewhere, was used [33]. A final preconcentration factor of 60 was achieved with a final composition of 10 % of MeOH in ultrapure water. Finally, in the case of olive oil, the method used, described elsewhere [34], is based on the official method AOAC.2007.01, with the cleanup step using EMR sorbent for the removal of coextracted lipids.

**Liquid chromatography.** The separation of selected analytes was carried out in an UHPLC system Agilent 1290 Infinity UHPLC (Agilent Technologies, Santa Clara, CA, USA) furnished with a binary pump, an autosampler, and equipped with an Agilent Zorbax Eclipse plus C-18 RRHD column (3.0 mm x 100 mm, 1.8 µm particle size) (Agilent Technologies, Santa Clara, CA, USA). Mobile phases were ultrapure water (A) and MeOH (B) both with 0.1% (v/v) HCOOH for ESI-amenable analytes and without the organic acid for organochlorine species. The chromatographic method started at 10% of B during 3 minutes, then a linear gradient from 10% B to 70% B for 2 minutes was set. After that, a linear gradient up to 100% B during ten minutes, and then, held constant for 2 more minutes, for a total run time of 17 minutes. The flow was kept constant at 0.4 ml min<sup>-1</sup>. Organochlorine required chromatographic gradient adjustment for improved separation, so that it started at 70% B for 2 minutes, then linear gradient up to 90% B was achieved in 2 min. This composition was kept constant for 4 more minutes and finally

gradient reached 100% B after other 10 min, it was maintained constant for 2 minutes (total run: 20 minutes). After each run, a 5-minute equilibration was performed with the initial mobile phase composition.

**DBDI, APCI and electrospray ionization sources.** The DBDI source was implemented into a commercial API source (Agilent Technologies, Santa Clara, CA, USA) so that the HPLC eluent was nebulized and vaporized in the same manner as for APCI. A scheme of DBDI LC-MS setup is shown in Figure 1 and some pictures of the DBDI interface are shown in Figure 2. Briefly, a low temperature plasma is generated between two ring electrodes (arranged in a glass capillary and separated by 1 cm) by the application of a high-voltage (2.5 kV) to the front electrode by an in-house built high voltage square wave generator at a frequency of 20 kHz [35] while a gas stream of 100 mL/min helium (purity 99.999%) is flowing through the glass capillary. This DBDI source was mounted replacing the corona needle from a commercial unmodified APCI source (Agilent Technologies, Santa Clara, CA) including a heated nebulizer, which was maintained at 350 °C for all experiments (except those performed with commercial ESI source). Nitrogen (5.0, 99.999%) was used as nebulizer gas at a pressure of 40 psi and 325 °C for all sources. The flow of this gas was set at 3.2 L min<sup>-1</sup> for DBDI and APCI experiments and 9.0 L min<sup>-1</sup> for ESI. The ion current for the APCI corona was 4 μA.

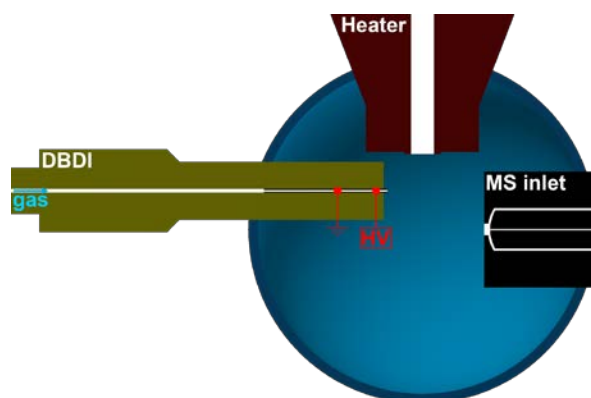

**Figure 1.** DBDI set up assembled in a commercially available APCI source, replacing the corona needle by the DBDI probe.



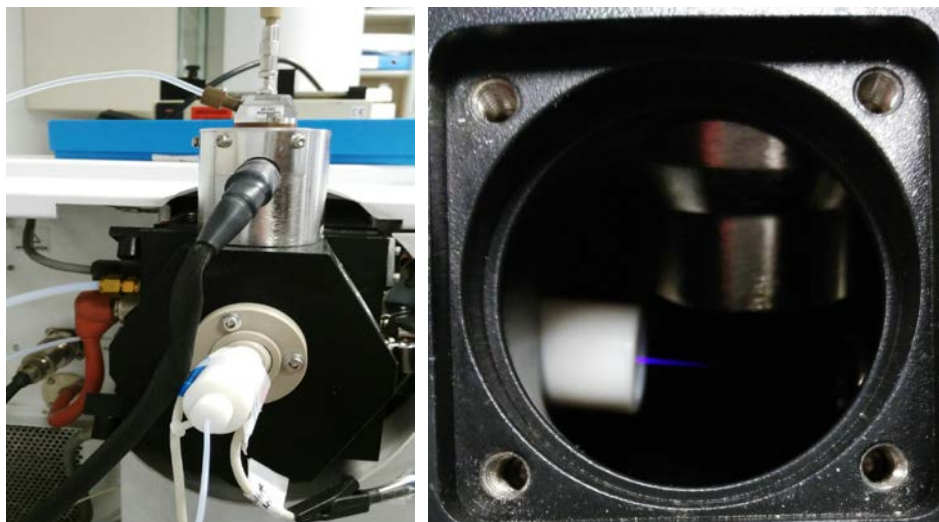

Figure 2. Photographs of the DBDI interface with LC-TOFMS instrument using the housing from the APCI source.

**Mass spectrometer.** The detection was carried out with a time-of flight mass spectrometer (Agilent 6220 accurate mass TOF, Agilent Technologies, Santa Clara, CA) in positive ionization mode for ESI-amenable pesticides and negative ionization for organochlorine species, using the following operation parameters: capillary voltage, 3500 V; skimmer voltage, 65 V; octopole RF, 250 V; fragmentor voltage: 190 V for ESI-amenable pesticides (positive ionization mode) and 140 V for organochlorine compounds (negative ionization mode). LC-MS accurate mass spectra were recorded across the range  $m/z$  50–1000, with an acquisition rate of 1.5 spectra per second. The instrument was operated in the 4-GHz high resolution mode, providing a typical resolution of ca. 19000 at  $m/z$  922. Extracted ion chromatograms (EICs) of each analyte were constructed with a mass extraction window of  $\pm 20$  ppm relative mass error. The full-scan data were recorded with Agilent Mass Hunter Data Acquisition software (version B.04.00) and processed with Agilent Mass Hunter Qualitative Analysis software (version B.04.00).

**Evaluation of matrix effects.** To examine the extent of the matrix effects (ME) with the different ionization methods compared, matrix-matched and solvent standard calibration

plots were constructed at 0.001, 0.01, 0.1, 0.5 and 1  $\mu\text{g mL}^{-1}$  for ESI-amenable compounds tested in positive ionization mode. For organochlorine pesticides, the concentration levels were as follows: 0.01, 0.1, 0.5, 1.0, 10.0  $\mu\text{g mL}^{-1}$ . ME were calculated by comparison of the slope obtained with matrix-matched standard and that obtained with solvent-based standards for each compound and was expressed in % of signal suppression (negative values) or enhancement (positive values). Three different matrices were employed for this purpose, orange, wastewater and olive oil. Matrix extracts were obtained by standard SPE for wastewater and QuEChERS for oranges following the procedures described in SI section. Analysis was carried out under optimized conditions in DBDI, APCI and ESI. According to SANTE guidelines [36], signal suppression or enhancement should be less than 20%. This criterion was initially considered as the reference, although, if the values were  $< \pm 10\%$ , ME was considered negligible; between 10 and 20% soft, above 20% and under 50% medium and over 50% of signal suppression or enhancement the ME is considered strong.

## Results and discussion

The better understanding of the mechanistic aspects of DBDI ionization in the positive ion mode permitted the breakdown of these discharges within two operation modes: filamentary and homogeneous, the latter being the more suited for soft ionization conditions [29]. The use of lower voltage amplitudes and square waveform generators - instead of sinusoidal- enhanced the production of the reagent species responsible for the final ionization of species with moderately proton affinity, providing an increase of sensitivity which, although envisaged in previous fundamental studies [29], has not been fully explored and demonstrated up to now. This article addresses for the first time the evaluation of the optimized DBDI source for quantitative trace analysis and the comparison of the main features (including ionization strength and adduct formation, ionization coverage, sensitivity and tolerance to matrix effects), with standard sources used for small molecule analysis, eg. ESI and DBDI. For this study, a representative group of ca. 80 multiclass pesticides with different physicochemical properties has been selected.

The seminal work from Alder et al. scrutinizing the ionization coverage of both GC-MS and LC-MS for the 500-most commonly used pesticides in Germany [1], concluded that, although ESI exhibited the ability to ionize nearly the 90% of the pesticides examined,

yet GC-MS (electron impact) remained necessary to provide a complete coverage. This fact opens the search for alternative ionization methods extending that coverage so that eventually, it may well be accomplished with a unique run or instrument.

The first reports on the use of DBDI and its application to pesticides included preliminary data showing the feasibility of simultaneously ionize species such as organochlorine pesticides or polycyclic aromatic hydrocarbons, which do not work at all with electrospray [21,28,31]. Although the data presented anticipated the potential application for food and environmental testing with limits of quantitation matching targeted concentration levels for some of the compounds studied, the study lacked from a thorough comparison with experimental data collected using analogous conditions and electrospray ionization. An example on the comparison of ESI and DBDI using sinusoidal waveform and 6.5 kV amplitude voltage, conditions associated to non-optimized ionization [28], is provided in Figure 3, which includes the determination of two pesticides (diazinon and buprofezin) using ESI and DBDI. Note the difference of the signal between ESI and DBDI of around two orders of signal intensity (100-fold for diazinon and ca. 500-fold for buprofezin).

The better understanding of the ionization source led to the adjustment and fine tuning of soft ionization features of the plasmajet, so that an improvement of the signal by over two orders of magnitude is realized in this work, thus approaching the performance of widely accepted gold standard ionization method (electrospray), while keeping the ability to ionize moderately apolar species out of reach to ESI ionization, such as for instance organochlorine compounds.

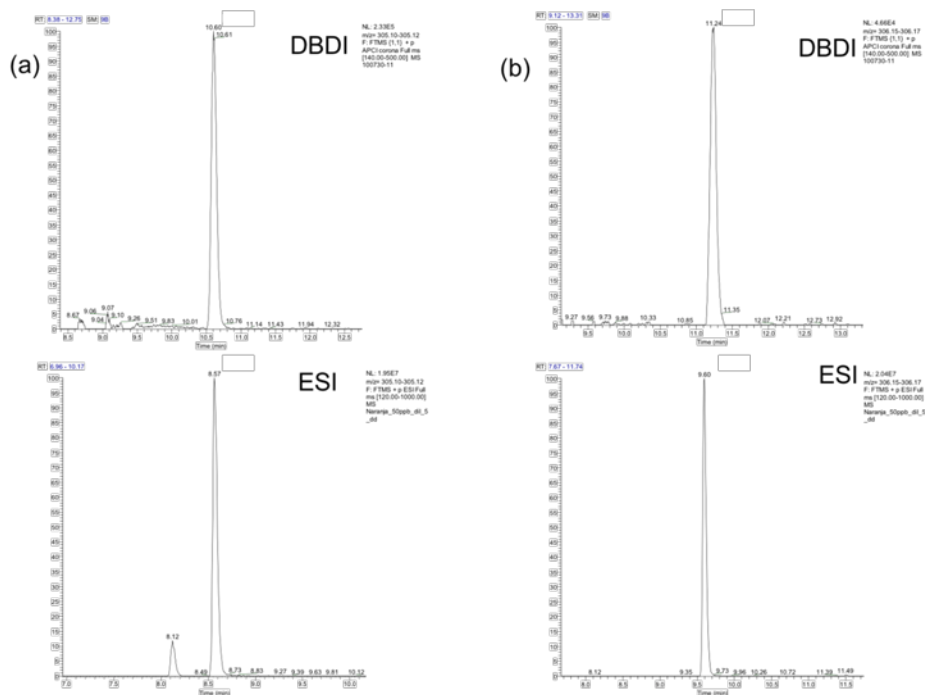

**Figure 3.** Comparison of DBDI operated in filamentary mode (6.5 kV amplitude voltage and sinusoidal waveform) and electrospray ionization using an IonMax™ commercial ESI source: (a) LC-HRMS extracted ion chromatogram of 10 µg kg<sup>-1</sup> of diazinon in orange ( $m/z$  305.1083); (b) LC-HRMS extracted ion chromatogram of 10 µg kg<sup>-1</sup> of buprofezin in orange ( $m/z$  306.1635). Data acquired using a Q-Exactive Orbitrap instrument operated in full-scan mode at resolution of *ca.* 70000. Note the normalized intensity of the extracted ion chromatograms (EICs). In the case of diazinon (a), the intensity for DBDI is 2.33 E+05, while for ESI is 1.96 E+07. In the case of buprofezin (b), the intensity for DBDI is 4.68 E+04, while for ESI is 2.04 E+07.

### Ionization features and adduct formation

The detailed information of retention time and main spectral features from the ionization of the studied pesticides using DBDI and ESI, is included in Tables 1 and 2 (Annex). The data reveal that both ESI and DBDI are soft ionization methods with little to no fragmentation. The actual fragmentation occurring for selected pesticides should be attributed to the so-called “in-source CID fragmentation”, which actually occurs during ion transportation at reduced pressures after crossing the inlet capillary [37]. The in-source CID fragmentation pattern observed for the compounds in the positive ion mode is very similar,

which means that there are no significant differences between the internal energy of ions generated by both sources in most cases. As can be observed in Table 1 (Annex), one of the major differences in the positive ionization mode is the absence of sodium adduct formation with DBDI for compounds, for those these adducts are common. As an example, the spectra observed in the positive ionization mode for selected analytes (viz. propachlor, tebufenpyrad and rotenone) are shown in Figure 4. The ESI-HRMS data of propachlor is an example of a superior performance in terms of  $[M+H]^+$  signal than with DBDI, although it also yields  $[M+Na]^+$  adduct. Interestingly, the fragment at  $m/z$  170 is the more abundant ion in ESI spectra with ca. 2-times more intensity than the protonated molecule, whereas in DBDI the abundance of such fragment and the protonated molecule is similar under comparable ion transportation conditions. This confirms the soft ionization nature of DBDI.

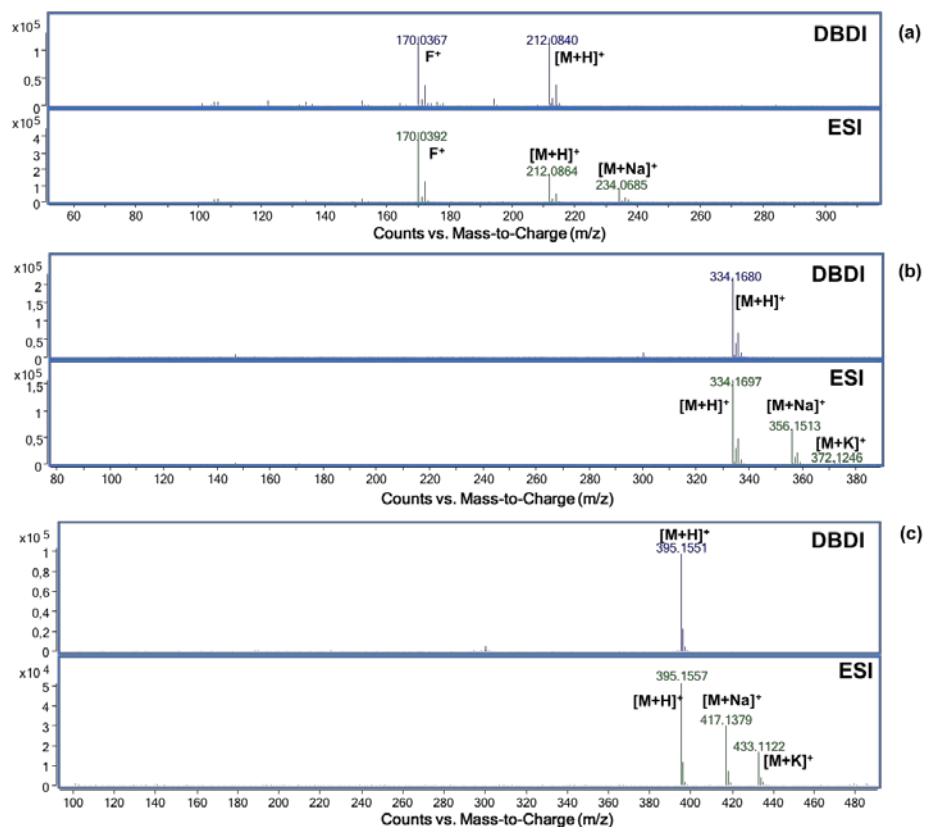
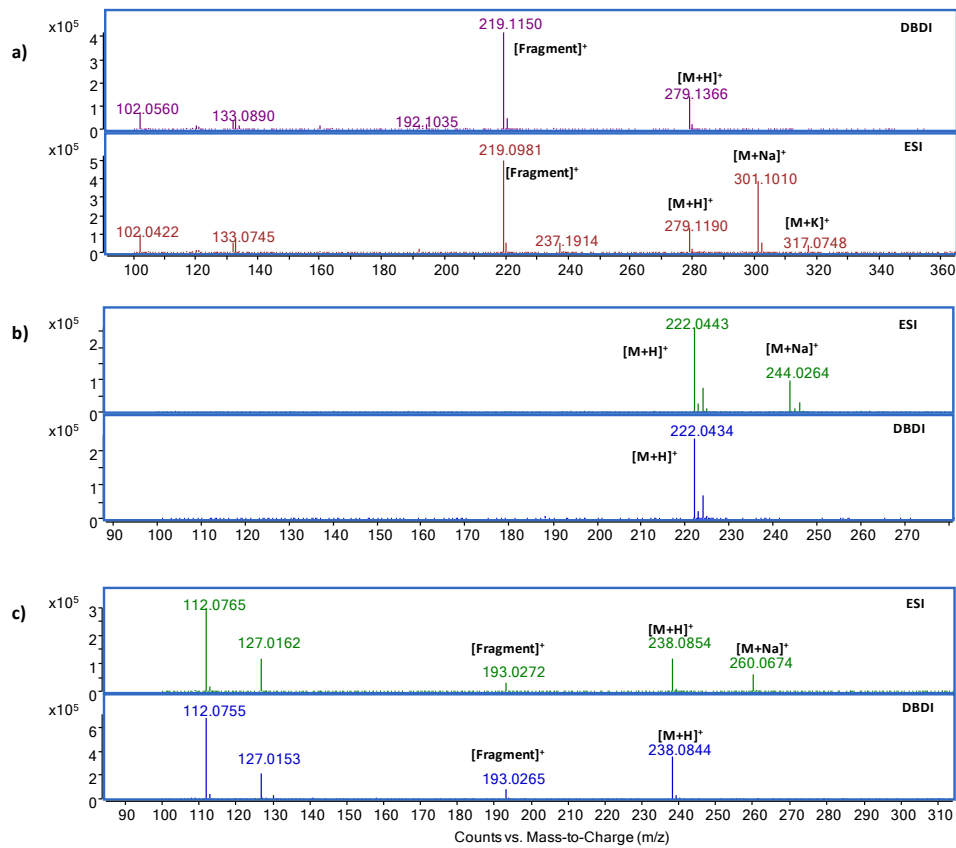

Figure 4. Mass spectral features of (a) propachlor, (b) tebufenpyrad and (c) rotenone using DBDI and ESI. Spectra collected with LC-TOFMS at a concentration level of  $100 \mu\text{g L}^{-1}$ .

The mass spectra of tebufenpyrad in DBDI and ESI are similar in the fact that  $[M+H]^+$  is the more abundant ion. However, while in DBDI there is no cationization, the ESI spectrum also revealed the presence of  $[M+Na]^+$  ( $m/z$  356) with a relative abundance around 50%, and also  $[M+K]^+$  ( $m/z$  372). This cationization effect reduces the signal of ESI, thus becoming lower than that obtained with DBDI. Likewise, rotenone exhibited a clean DBDI spectrum with only  $[M+H]^+$ , while with ESI it also undergoes sodium and potassium adduct formation, which reduces significantly its signal. DBDI spectra of oxadixyl, chloridazon and dicrotophos are shown in Figure 5.

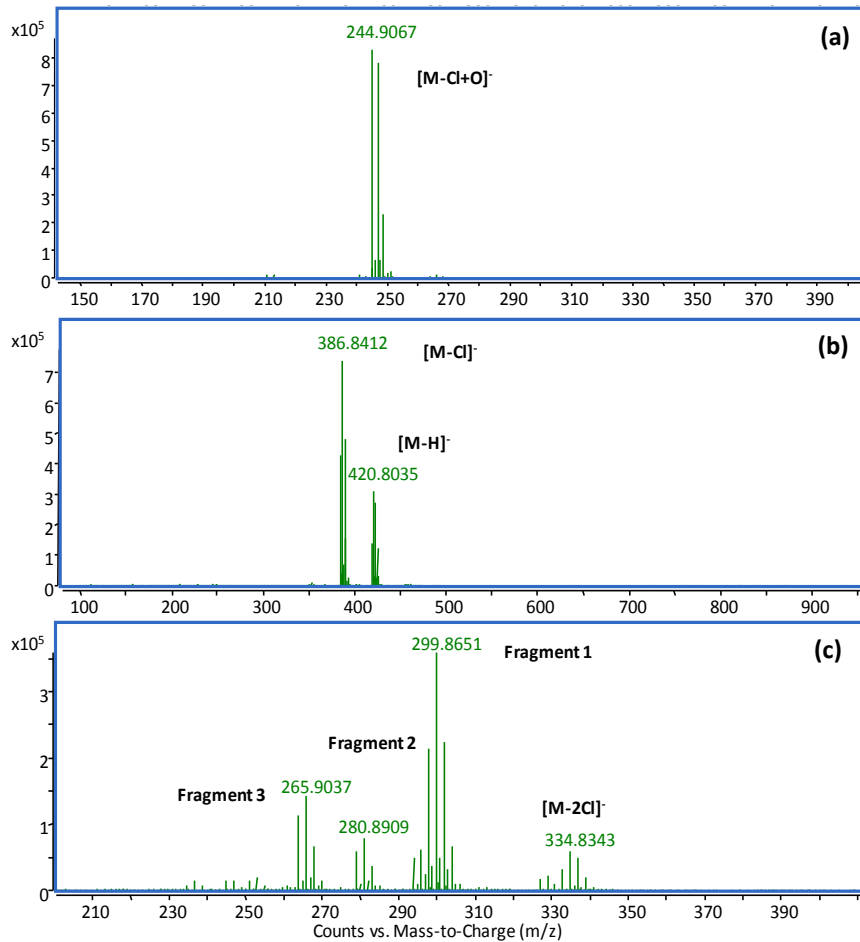

**Figure 5.** Mass spectral features of (a) oxadixyl, (b) chloridazon and (c) dicrotophos using DBDI and ESI. Spectra collected with LC-TOFMS at a concentration level of  $100 \mu\text{g L}^{-1}$ .

Therefore, the main feature exhibited by DBDI was the absence of sodium adduct formation. This fact can be attributed to the mechanism of DBDI, occurring in the gas-phase, so that the formation of adducts, commonly seen in ESI due to the presence of metal ion impurities (Na, K) in the surrounding environment is not occurring. This feature also involves several advantages. Notably, the occurrence of sodium adducts is usually associated to significant matrix effects, since small changes of the sample composition may derive in major analyte signal drifting and differences on the mass spectrum observed and the relative abundance of cation adducts compared to the protonated molecule. Another aspect associated to sodium adduct formation is the reduced sensitivity, as different fractions of the molecules are ionized by different means, thus decreasing the signal observed for each individual ion species. In addition, sodium adducts are usually non-desirable, as they are more difficult to cleave and yield efficient MS/MS spectra than protonated molecules. Finally, the occurrence of sodium adduct expands the number of compounds or spectral features that should be addressed with data mining tools. In this context, the absence of redundant information (such as that provided by adducts) eases the handling, mining and interpretation of the data.

Meanwhile, in the negative ionization mode, the scenario is completely different. All organochlorine compounds were also tested individually by ESI and APCI at concentrations of up to 10 mg/L. In the case of APCI, nearly negligible signals of hexachlorobenzene, heptachlor and endosulfan sulfate were detected at the highest concentration level. With ESI, endosulfan  $\beta$  and endosulfate sulfate offered signals comparable to those of DBDI, although in both cases significantly worse. This inexistent or poor ionization of organochlorine analytes by APCI and ESI was previously described [1]. The detailed information of spectral features with DBDI is shown in Table 2 (Annex). As an example, Figure 6 shows the spectra of three representative organochlorine compounds: chlorotalonil, endosulfan sulfate and heptachlor. Different ways of ionization were observed in negative mode. Several species detected may be attributed to dissociative processes after electron capture of electronegative atoms, with the optional subsequent oxygen addition as previously described by other authors in plasma-based ionization methods such as DART, which may well be related to the presence of superoxide ions ( $O_2^-$ ) [38]. Processes such as the loss of  $HSO_2^-$  ( $[M-HSO_2]^-$ ) for endosulfan for which  $[M-H]^-$  and  $[M+Cl]^-$  were also present, or hexachlorobenzene (yielding  $[M-Cl+O]^-$ ) are examples of

these phenomena. Chlorotalonil, hexachlorobenzene, and quintozene, all without readily hydrogen atoms in their structures, were ionized by nucleophilic aromatic substitution resulting in the  $[M-Cl+O]^-$  ion, as occurred with ionization of perfluorinated compounds [39]. An example of the extracted ion chromatograms using LC-DBDI-MS in the negative ion mode is shown in Figure 7.



**Figure 6.** Three representative organochlorine compound spectra by DBDI: (a) chlortalonil, (b) endosulfan sulfate and; (c) heptachlor.



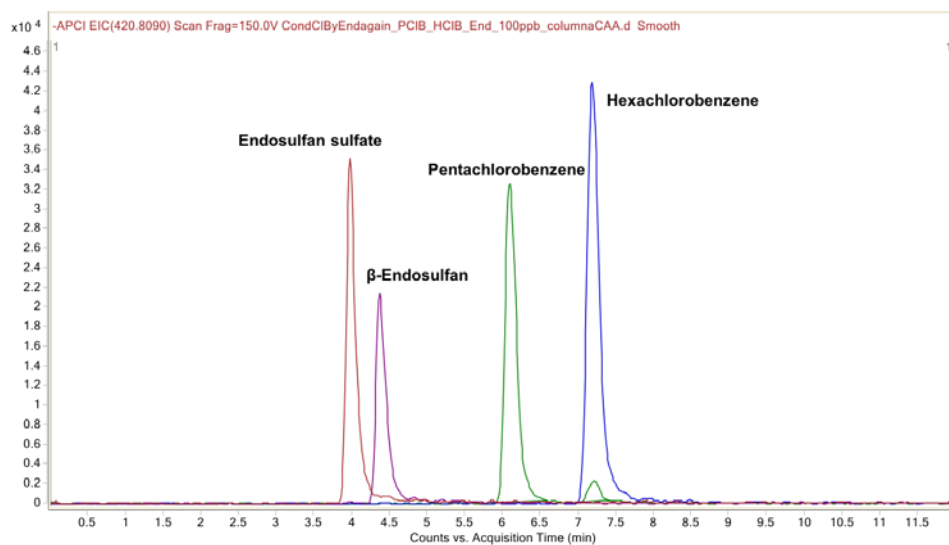

**Figure 7.** Overlapped extracted ion chromatograms obtained with LC-DBDI-HRMS for endosulfan sulfate,  $\beta$ -endosulfan, pentachlorobenzene and hexachlorobenzene at a concentration level of  $100 \mu\text{g L}^{-1}$ .

These ionization (and fragmentation) mechanisms, contrasting to those displayed in the positive ionization mode, can no longer be regarded as soft as they involve the cleavage of C-Cl bonds in many cases. This is what justifies the extended coverage offered by DBDI, enabling the detection of all tested organochlorine compounds, which could not be detected by ESI, with only three exceptions. Additional studies were also performed (data not shown) with other key compounds with a clear interest as they do not work properly in GC-MS or LC-MS, such as folpet, which is detected as a degradation product from the injection port (phthalimide) in GC-MS, being not effectively ionized in ESI. Another example is dazomet, with a really low efficiency in ESI, meanwhile the results in DBDI are satisfactory. The post-harvest fungicide 2-hydroxybiphenyl (aka o-phenylphenol) also exhibits poor sensitivity in APCI and ESI, compared to the satisfactory results attained with DBDI. Further studies are conducted to unravel the ionization mechanisms in both positive and negative ionization mode, so that the ionization efficiency of DBDI could be predicted.

### Performance: sensitivity

Although the sensitivity enhancement has been anticipated in the previous discussion, and is illustrated with the comparison of DBDI and ESI spectra shown, a detailed study comparing signals obtained with ESI, APCI and DBDI was accomplished. As an example, the extracted ion chromatograms obtained using LC-HRMS and ESI or DBDI ionization for the determination of selected neonicotinoid insecticides (acetamiprid, imidacloprid and thiamethoxam) and rotenone are shown in Figure 8. They revealed an increase of signal with DBDI compared to ESI. This can be mainly attributed to the absence of cationization with Na or K which occurs in ESI. Not only this affects to the overall signal but also has an impact on matrix effects. The signal-to-noise ratios observed at low ng/g concentration levels illustrate the usefulness of the proposed ionization method compared to overall sensitivity requirements set by current EU MRLs [40], which can be further improved with more sensitive HRMS or MS/MS instrumentation.

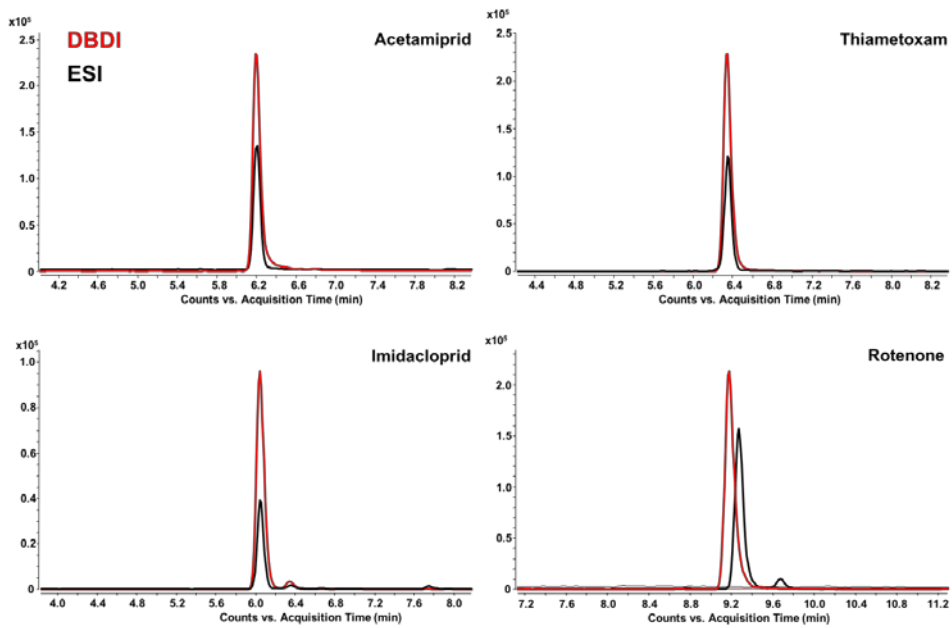

Figure 8. Extracted ion chromatograms for acetamiprid, imidacloprid, thiamethoxam and rotenone using LC-HRMS with DBDI (red) and ESI sources (black).

The study is summarized in Figure 9, where the ratios between calibration curves slopes obtained with DBDI are compared to those obtained with ESI and APCI. Thus, slope ratios above 1 means higher sensitivity of DBDI method, whereas if the values are below the unit, the scenario is the opposite. It should be noted that the 18 organochlorine compounds included were better with DBDI, since either they were not detected at all or the signal achieved with ESI or APCI was not usable for trace analysis purposes. For the rest of compounds, ESI offered slightly better results than DBDI for ca. 60% of the compounds, whereas DBDI was superior for around 30% and all the organochlorine compounds. This scenario is basically constant regardless the matrix used for the evaluation of calibration plots.

It should be highlighted that the linearity was appropriate in the concentration ranges tested, being finally limited by the mass analyzer rather than by the ionization source, which means that there is an excess of reagent species responsible for the ionization in the positive ion mode, and this might be also related with the reduced matrix effects displayed by DBDI in comparison with ESI or APCI.

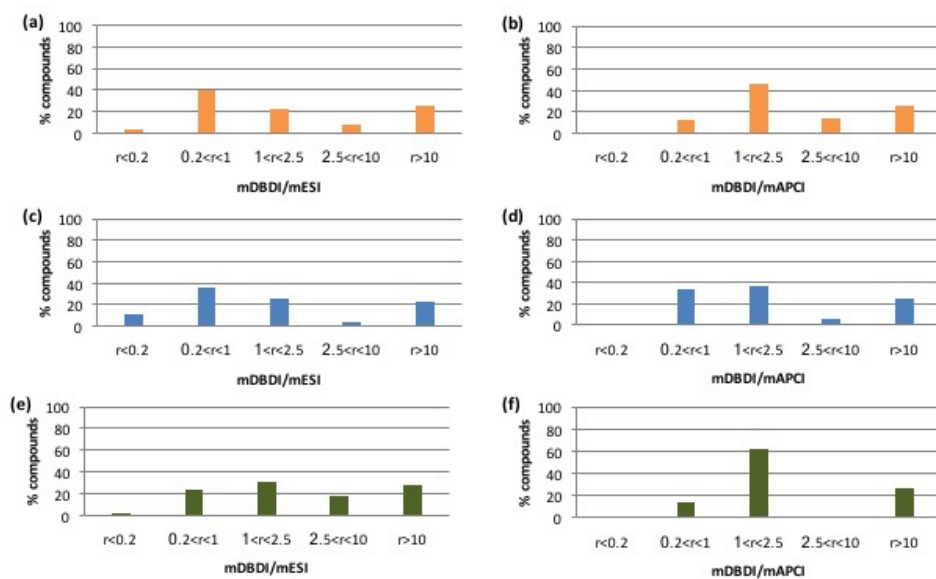
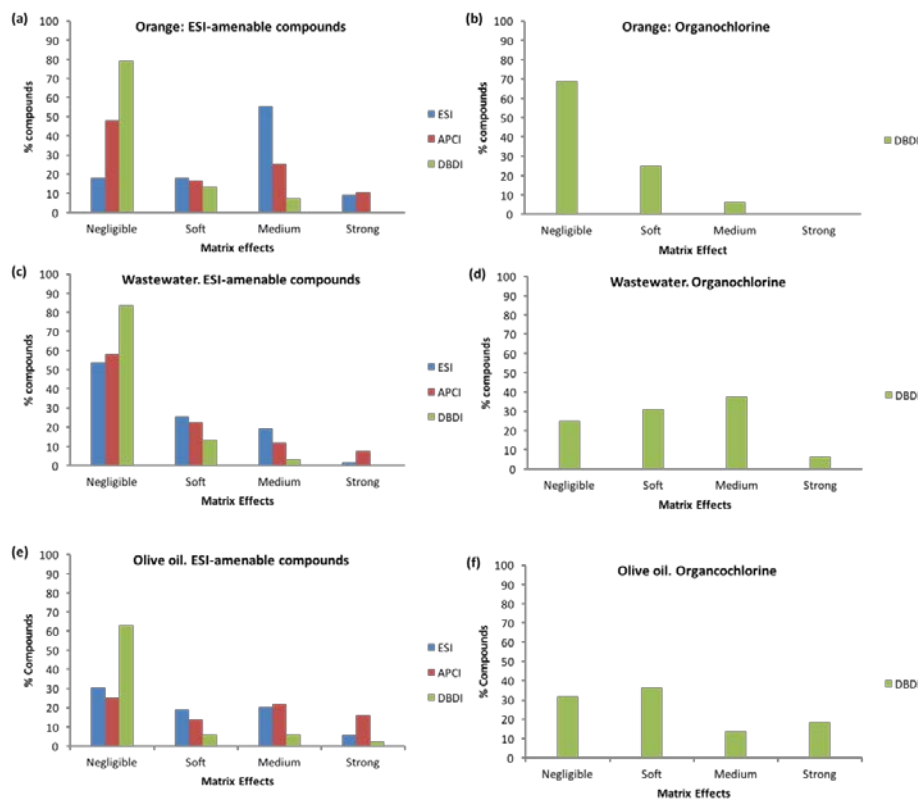

Figure 9. Evaluation of sensitivity using DBDI, APCI and ESI in (a) orange, (b) wastewater; and (c) olive oil.

**Matrix effects and mechanistic implications.** Matrix effects are linked also to the ionization mechanism and the ability to skip cationization phenomena, more likely to occur with droplet-based ionization methods [41,42]. To evaluate the tolerance of DBDI to ion suppression or enhancement due to coeluting species, three representative matrices were selected: orange, wastewater (an SPE extract of effluent wastewater) and olive oil. The slopes of calibration curves obtained from spiked matrix-matched standards using DBDI, ESI and APCI were compared with the corresponding slopes using neat solvent standards. The results (Figure 10) were breakdown in multiclass pesticides in the positive ionization mode and organochlorine compounds, which were only detected with significant signal by DBDI, only with a few exceptions such as endosulfan isomers, endosulfan sulfate and chlorotalonil (for details, see Tables 3 to 8 in the Annex).



**Figure 10.** Comparative evaluation of matrix effects occurring with DBDI, ESI and APCI in orange, wastewater and olive oil. Results are breakdown in two groups: those compounds amenable by ESI, and organochlorine pesticides, only amenable by DBDI. The classification of: negligible ( $< \pm 10\%$  slope change), soft (between  $\pm 10$  to  $20\%$  slope change), medium (between  $\pm 20$  and  $50\%$  slope change) or strong (beyond  $50\%$  slope change) is adapted from previous literature [43].

In the case of the ESI-amenable group, the data from orange revealed that ca. 90% of compounds studied from this group displayed negligible to minor matrix effects when using DBDI, while with APCI and ESI only 70% and 30% of the compounds could fulfil this criterion respectively. On the other hand, nearly 70 % of the compounds in ESI suffered medium to strong matrix effects in orange. The pattern obtained in wastewater extract was similar to orange, with minimized matrix effects again for DBDI method. In olive oil, the signal suppression for all the three cases was significantly higher, which can be attributed to the additional complexity of this matrix. These results in the positive ion mode are significantly different than those previously reported using DBDI operated in the filamentary mode [31], which did not exhibit such remarkable advantage compared to APCI or ESI. The differences with ESI can be easily attributed to the absence of surface phenomena during ionization together with the sodium adduct formation in ESI as it has been previously mentioned, while the improvement compared to APCI could be attributed to a more efficient reagent ion production with the helium plasma jet than with the corona needle, when operating at homogenous plasma regime [29], where the production of protonated water clusters and subsequent proton transfer reactions are maximized.

Interestingly, the pattern of matrix effects in the negative ion mode of DBDI is different, with the organochlorine compounds subjected to a higher rate of signal suppression with over 35 % of the tested species displaying typically medium signal suppression. This is an experimental evidence on the different ionization mechanisms undergone in the negative ionization mode. Further studies are required to unravel and further optimize the performance of DBDI in this ionization mode.

## **Conclusions**

This study addresses the first thorough comparison of DBDI with commercial instrumentation. The performance compared well with ESI in terms of sensitivity, offering additional advantages in aspects such as ionization coverage, matrix effects and absence of cationization phenomena. The usefulness of LC-DBDI-MS as a robust method for trace analysis of ESI and non-ESI-amenable pesticides has been demonstrated. Analyte coverage in DBDI is enhanced respect to ESI and APCI sources since it is able to effectively

analyze organochlorine compounds. In positive ionization mode, salt adduct are not formed which is an advantage against ESI ionization where the occurrence of Na adducts is common. DBDI stands as a powerful tool for overcoming matrix effects since it showed negligible matrix effect value (<10%) for most of selected compounds in the studied matrices. In general, average limits of quantitation for DBDI were similar that those obtained by ESI and better than APCI. Further studies are being completed to optimize the production of reagent species responsible for negative ion mode DBDI ionization.

#### **AUTHOR INFORMATION**

Corresponding author:

Tel.: (+49) 2311392174. Fax: (+49) 2311392200 E-mail: [joachim.franzke@isas.de](mailto:joachim.franzke@isas.de)

Notes. The authors declare no competing financial interest

#### **Acknowledgements**

The authors acknowledge funding from DFG (Ref. 262732688), the Spanish Ministerio de Economía y Competitividad (MINECO) (Ref. CTQ2012-34297 and CTQ2015-71321-P) and Junta de Andalucía (FQM-2242). F.J.L.O. acknowledges a FPI grant from MINECO (Ref. BES2013-064-014).

## References

- [1] Alder, L., Greulich, K., Kempe, G., Vieth, B. Residue analysis of 500 high priority pesticides: better by GC-MS or LC-MS/MS?. *Mass Spectrom. Rev.*, 2006, 25, 838-865.
- [2] Trufelli, H., Palma, P., Famigliini, G., Cappiello, A. An overview of matrix effects in liquid chromatography-mass spectrometry. *Mass Spectrom. Rev.*, 2011, 30, 491-509.
- [3] Ferrer, C., Lozano, A., Agüera, A., Jiménez-Girón, A., Fernández-Alba, A.R. Overcoming matrix effects using the dilution approach in multiresidue methods for fruits and vegetables. *J. Chromatogr. A*, 2011, 1218, 7634-7639.
- [4] Tang, L., Kebarle, P. Dependence of ion intensity in electrospray mass spectrometry on the concentration of the analytes in electrosprayed solution. *Anal. Chem.*, 1993, 65, 3654-3668.
- [5] Niessen, W.M.A., Manini, P., Andreoli, R. Matrix effects in quantitative pesticide analysis using liquid chromatography-mass spectrometry. *Mass Spectrom. Rev.*, 2006, 25, 881-899.
- [6] Krueve, A., Leito, A., Herodes, K. Combating matrix effects in LC/ESI/MS: the extrapolative dilution approach. *Anal. Chim. Acta*, 2009, 651, 75-80.
- [7] Kulyk, D.S., Miller, C.F.; Badu-Tawiah, A.K. Reactive charged droplets for reduction of matrix effects in electrospray ionization mass spectrometry. *Anal. Chem.*, 2015, 87, 10988-10994.
- [8] Romero-González, R., Arrebola-Liebanas, F.J., López-Ruiz, R., Garrido-Frenich, A. Sample treatment in Pesticide Residue Determination in Food by High-Resolution Mass Spectrometry: Are Generic Extraction methods the end of the Road? *J. AOAC Int.*, 2016, 99, 1395-1402.
- [9] Stahnke, H., Kittlaus, S., Kempe, G., Alder, L. Reduction of Matrix Effects in Liquid Chromatography-Electrospray Ionization-Mass Spectrometry by Dilution of the Sample Extracts: How much dilution is needed? *Anal. Chem.*, 2012, 84, 1474-1482.
- [10] Fernández-Fernández, M., Rodríguez-González, P., Añón-Alvarez, M.E., Rodríguez, F., Álvarez-Menéndez, F.V., García-Alonso, J.I. Simultaneous determination of creatinine and creatine in human serum by double-spike isotope dilution liquid chromatography-tandem mass spectrometry (LC-MS/MS) and gas chromatography-mass spectrometry (GC-MS). *Anal. Chem.*, 2015, 87, 3755-3763.

- [11] Somoano-Blanco, L., Rodríguez-González, P., García Fonseca, S., García-Alonso, J.I. Determination of polychlorinated biphenyls in solid samples by isotope dilution mass spectrometry using  $^{37}\text{Cl}$ -labeled analogues. *Anal. Chem.*, 2015, 87, 7840-7847.
- [12] Stokvis, E., Rosing, H., Beijnen, J.H. Stable isotopically labeled internal standards in quantitative bioanalysis using liquid chromatography/mass spectrometry: necessity or not? *Rapid Commun. Mass Spectrom.*, 2005, 19, 401-407.
- [13] Cappiello, A., Famiglini, G., Palma, P., Pierini, E., Termopoli, V., Trufelli, H. Overcoming matrix effects in liquid chromatography-mass spectrometry. *Anal. Chem.*, 2008, 80, 9343-9348.
- [14] Gangl, E.T., Anna, M., Spooner, N., Vouros, P. Reduction of Signal Suppression Effects in ESI-MS using a Nanosplitting device. *Anal. Chem.*, 2001, 73, 5635-5644.
- [15] Rebane, E.; Krueve, A.; Liigand, P.; Liigand, J.; Herodes, K.; Leito, I. Establishing atmospheric pressure chemical ionization efficiency scale. *Anal. Chem.*, 2016, 88, 3435-3439.
- [16] Smoluch, M.; Mielczarek, P.; Silberring, J. Plasma-based ambient ionization mass spectrometry in bioanalytical sciences. *Mass Spectrom. Rev.*, 2016, 35, 22-34.
- [17] Ding, X.; Duan, Y. Plasma-based ambient mass spectrometry techniques: the current status and future prospective. *Mass Spectrom. Rev.*, 2015, 34, 449-473.
- [18] Na, N., Zhao, M., Zhang, S., Yang, C., Zhang, X., Development of a Dielectric Barrier Discharge Ion Source for Ambient Mass Spectrometry. *J. Am. Soc. Mass Spectrom.*, 2007, 18, 1859–1862
- [19] Harper J.D., Charipar N.A., Mulligan C.C., Zhang, X., Cooks, R.G., Ouyang, Z. Low-temperature plasma probe for ambient desorption ionization. *Anal. Chem.*, 2008, 80, 80, 9097–9104.
- [20] Norgaard, A.W.; Kofoed-Sorensen, V.; Svensmark, B.; Wolkoff, P.; Clausen, P.A. Gas chromatography interfaced with atmospheric pressure ionization-quadrupole time-of-flight mass spectrometry by low temperature plasma ionization. *Anal. Chem.* 2013, 85, 28-32.
- [21] Hayen, H., Michels, A.; Franzke, J. Dielectric barrier discharge ionization for liquid chromatography/mass spectrometry. *Anal. Chem.*, 2009, 81, 10239-1024.
- [22] Mirabelli, M.F.; Wolf, J.-C. Zenobi, R. Pesticide analysis at ppt concentration levels: coupling nano-liquid chromatography with dielectric barrier discharge ionization mass spectrometry. *Anal. Bioanal. Chem.*, 2016, 408, 3425-3434.



- [23] Zhang, Y.; Ai, W.; Bai, Y.; Zhou, Y.; Wen, L.; Zhang, X.; Liu, H. An interface for online coupling capillary electrophoresis to dielectric barrier discharge ionization mass spectrometry. *Anal. Bioanal. Chem.*, 2016, 408, 8655-8661.
- [24] Liu, Y.; Ma, X.; Lin, Z.; He, M.; Han, G.; Yang, C.; Xing, Z.; Zhang, S.; Zhang, X. Imaging mass spectrometry with a Low-Temperature Plasma Probe for the analysis of works of art. *Angew. Chem. Int. Ed.*, 2010, 49, 4435-4437
- [25] Meyer, C.; Müller, S.; Gurevich, E.L.; Franzke, J. Dielectric barrier discharges in analytical chemistry. *Analyst*, 2011, 136, 2427-2440.
- [26] Guo, C.; Tang, F.; Chen, J.; Wang, X.; Zhang, S.; Zhang, X. Development of dielectric-barrier-discharge ionization. *Anal. Bioanal. Chem.*, 2015, 407, 2345-2364.
- [27] Brandt, S.; Klute, F.D.; Schütz, A.; Franzke, J. Dielectric barrier discharges applied for soft ionization and their mechanism. *Anal. Chim. Acta.*, 2017, 951, 16-31.
- [28] Gilbert-López, B.; García-Reyes, J.F.; Meyer, C.; Michels, A.; Franzke, J.; Molina-Díaz, A.; Hayen, H. Simultaneous testing of multiclass organic contaminants in food and environment by liquid chromatography/dielectric barrier discharge ionization-mass spectrometry. *Analyst*, 2012, 137, 5403-5410.
- [29] Meyer, C., Müller, S., Gilbert-López, B., Franzke, J. Impact of homogeneous and filamentary discharge modes on the efficiency of dielectric barrier discharge ionization mass spectrometry. *Anal. Bioanal. Chem.*, 2013, 405, 4729-4735.
- [30] Horvatic, V., Michels, A., Ahlmann, N., Jestel, G., Veza, D., Vadla, C., Franzke, J. Time-resolved spectroscopy of a homogeneous dielectric barrier discharge for soft ionization driven by square wave high voltage. *Anal. Bioanal. Chem.*, 2015, 407, 7973-7981.
- [31] Gilbert-López, B.; Geltenpoth, H.; Meyer, C.; Michels, A.; Hayen, H.; Molina-Díaz, A.; García-Reyes, J.F.; Franzke, J. Performance of dielectric barrier discharge ionization mass spectrometry for pesticide testing: a comparison with atmospheric pressure chemical ionization and electrospray ionization. *Rapid Commun. Mass Spectrom.*, 2013, 27, 419-429.
- [32] Lehotay, S.J.; Maštovská K.; Lightfield A.R. Use of buffering and other means to improve results of problematic pesticides in a fast and easy method for residue analysis of fruits and vegetables. *J. AOAC Int.*, 2005, 88, 615-629.
- [33] Robles-Molina, J.; Lara-Ortega, F.J.; Gilbert-López, B.; García-Reyes J.F.; Molina-Díaz A. Multi-residue method for the determination of over 400 priority and emerging

pollutants in water and wastewater by solid-phase extraction and liquid chromatography time-of-flight mass spectrometry. *J. Chromatogr. A.*, 2014, 1350, 30-43.

[34] López-Blanco, R., Nortes-Méndez, R., Robles-Molina, J., Moreno-González, D., Gilbert-López, B., García-Reyes, J.F., Molina-Díaz, A. Evaluation of different cleanup sorbents for multiresidue pesticide analysis in fatty vegetable matrices by liquid chromatography tandem mass spectrometry. *J. Chromatogr. A.*, 2016, 1456, 89-104.

[35] Schütz, A., Brandt, S.; Liedtke, S.; Foest, D.; Marggraf, U.; Franzke, J. Dielectric Barrier Discharge Ionization of Perfluorinated Compounds. *Anal. Chem.*, 2015, 87, 11415–11419

[36] European Commission, 2015 (SANTE/11945/2015). Guidance document on analytical quality control and method validation procedures for pesticides residues analysis in food and feed.

[37] Abranko, L.; García-Reyes, J.F.; Molina-Díaz, A. In-source fragmentation and accurate mass analysis of multiclass flavonoid conjugates by electrospray ionization time-of-flight mass spectrometry. *J. Mass Spectrom.*, 2011, 46, 471-476.

[38] Song, L.; Andrew B.; Yao H.; Bartmess J.E. Ionization Mechanism of Negative Ion-Direct Analysis in Real Time: A Comparative Study with Negative Ion-Atmospheric Pressure Photoionization *J. Am. Soc. Mass Spectrom.* 2009, 20, 42-50

[39] Schütz, A.; Brandt, S.; Liedtke, S.; Foest, D.; Marggraf, U.; Franzke, J. Dielectric barrier discharge ionization of perfluorinated compounds. *Anal. Chem.*, 2015, 87, 11415-11419.

[40] Regulation (EC) No. 396/2005 of the European Parliament and of the Council on Maximum Residue Levels of Pesticides in or on Food and Feed of Plant and Animal Origin and Amending Council Directive 91/414/EEC, *Official Journal of the European Communities* 2005, No. L70, 1-16.

[41] Schmidt, A.; Karas, M.; Dülcks, T. Effect of different solution flow rates on analyte ion signals in nano-ESI MS, or: when does ESI turn into nano-ESI. *J. Am. Soc. Mass Spectrom.*, 2003, 14, 492-500.

[42] Susa, A.C.; Williams, E.R. Small emitter tips for native mass spectrometry of proteins and protein complexes from nonvolatile buffers that mimic the intracellular environment. *Anal. Chem.*, 2017, 89, 3116-3122.

[43] Moreno-González, D.; Pérez-Ortega, P.; Gilbert-López, B.; Molina-Díaz, A.; García-Reyes, J.F.; Fernández-Alba, A.R. Evaluation of nanoflow liquid chromatography high

resolution mass spectrometry for pesticide residue analysis in food. *J. Chromatogr. A.*, 2017, 1512, 78-87.

## ANNEX

**Table 1.** LC-DBDI-HRMS determination of ESI-amenable compounds by DBDI in positive ionization mode and related data using electrospray, including additional adducts formed and common in-source fragment ions.

Source	Compound	Elemental composition (M)	Ret. time (min)	[M+H] <sup>+</sup>	[M+Na] <sup>+</sup>	[M+K] <sup>+</sup>	Fragments <sup>a</sup>
DBDI	Bitertanol	C <sub>20</sub> H <sub>23</sub> N <sub>3</sub> O <sub>2</sub>	10.1	338.1863	--	--	269.1536 (*), 144.1016
ESI	Bitertanol	C <sub>20</sub> H <sub>23</sub> N <sub>3</sub> O <sub>2</sub>	10.2	338.1863	360.1682	--	269.1536 (*), 251.1475
DBDI	Boscalid	C <sub>18</sub> H <sub>12</sub> Cl <sub>2</sub> N <sub>2</sub> O	8.13	343.0399 (*)	--	--	--
ESI	Boscalid	C <sub>18</sub> H <sub>12</sub> Cl <sub>2</sub> N <sub>2</sub> O	8.19	343.0399 (*)	365.0219	--	--
DBDI	Bromuconazol 1	C <sub>13</sub> H <sub>12</sub> BrCl <sub>2</sub> N <sub>3</sub> O	8.61	375.9614 (*)	--	--	--
ESI	Bromuconazol 1	C <sub>13</sub> H <sub>12</sub> BrCl <sub>2</sub> N <sub>3</sub> O	8.66	375.9614 (*)	--	--	--
DBDI	Bromuconazol 2	C <sub>13</sub> H <sub>12</sub> BrCl <sub>2</sub> N <sub>3</sub> O	9.48	375.9614 (*)	--	--	158.9742
ESI	Bromuconazol 2	C <sub>13</sub> H <sub>12</sub> BrCl <sub>2</sub> N <sub>3</sub> O	9.56	375.9614 (*)	--	--	158.9742
DBDI	Bupirimate	C <sub>13</sub> H <sub>24</sub> N <sub>4</sub> O <sub>3</sub> S	9.27	317.1642 (*)	--	--	--
ESI	Bupirimate	C <sub>13</sub> H <sub>24</sub> N <sub>4</sub> O <sub>3</sub> S	7.93	317.1642 (*)	339.1461	--	--
DBDI	Chloridazon	C <sub>10</sub> H <sub>8</sub> ClN <sub>3</sub> O	6.29	222.0429 (*)	--	--	--
ESI	Chloridazon	C <sub>10</sub> H <sub>8</sub> ClN <sub>3</sub> O	6.29	222.0429 (*)	244.0248	259.9987	--
DBDI	Chloroxuron	C <sub>15</sub> H <sub>15</sub> ClN <sub>2</sub> O <sub>2</sub>	8.64	291.0895 (*)	--	--	220.0528
ESI	Chloroxuron	C <sub>15</sub> H <sub>15</sub> ClN <sub>2</sub> O <sub>2</sub>	8.73	291.0895 (*)	313.0714	--	--
DBDI	Cyproconazol 1	C <sub>15</sub> H <sub>18</sub> ClN <sub>3</sub> O	8.45	292.1211 (*)	--	--	--
ESI	Cyproconazol 1	C <sub>15</sub> H <sub>18</sub> ClN <sub>3</sub> O	8.52	292.1211 (*)	314.1031	--	--
DBDI	Cyproconazol 2	C <sub>15</sub> H <sub>18</sub> ClN <sub>3</sub> O	8.75	292.1211 (*)	--	--	--
ESI	Cyproconazol 2	C <sub>15</sub> H <sub>18</sub> ClN <sub>3</sub> O	8.81	292.1211 (*)	--	--	--
DBDI	Dichlorvos	C <sub>4</sub> H <sub>7</sub> Cl <sub>2</sub> PO <sub>4</sub>	6.77	220.9532 (*)	--	--	--
ESI	Dichlorvos	C <sub>4</sub> H <sub>7</sub> Cl <sub>2</sub> PO <sub>4</sub>	6.78	220.9532 (*)	242.9351	--	--

Resultados y discusión

DBDI	Dicrotophos	C <sub>8</sub> H <sub>16</sub> NPO <sub>5</sub>	5.86	238.0839 (*)	--	--	193.0286, 127.0173, 112.0782
ESI	Dicrotophos	C <sub>8</sub> H <sub>16</sub> NPO <sub>5</sub>	5.86	238.0839 (*)	260.0658	--	193.0286, 127.0173, 112.0782
DBDI	Diniconazole	C <sub>15</sub> H <sub>17</sub> Cl <sub>2</sub> N <sub>3</sub> O	10.53	326.0821 (*)	--	--	--
ESI	Diniconazole	C <sub>15</sub> H <sub>17</sub> Cl <sub>2</sub> N <sub>3</sub> O	10.62	326.0821 (*)	348.0641	--	--
DBDI	Fenazaquin	C <sub>20</sub> H <sub>22</sub> N <sub>2</sub> O	13.54	307.1805 (*)	--	--	--
ESI	Fenazaquin	C <sub>20</sub> H <sub>22</sub> N <sub>2</sub> O	13.45	307.1805 (*)	329.1624	--	--
DBDI	Fenpropimorph	C <sub>20</sub> H <sub>33</sub> NO	9.53	304.2635 (*)	--	--	--
ESI	Fenpropimorph	C <sub>20</sub> H <sub>33</sub> NO	7.05	304.2635 (*)	--	--	--
DBDI	Fluquinconazole	C <sub>16</sub> H <sub>8</sub> Cl <sub>2</sub> FN <sub>5</sub> O	8.69	376.0163 (*)	--	--	--
ESI	Fluquinconazole	C <sub>16</sub> H <sub>8</sub> Cl <sub>2</sub> FN <sub>5</sub> O	8.75	376.0163 (*)	397.9982	--	--
DBDI	Flusilazole	C <sub>16</sub> H <sub>15</sub> F <sub>2</sub> N <sub>3</sub> Si	9.11	316.1076 (*)	--	--	--
ESI	Flusilazole	C <sub>16</sub> H <sub>15</sub> F <sub>2</sub> N <sub>3</sub> Si	9.19	316.1076 (*)	--	--	--
DBDI	Flutriafol	C <sub>16</sub> H <sub>13</sub> F <sub>2</sub> N <sub>3</sub> O	7.25	302.1099 (*)	--	--	233.0762
ESI	Flutriafol	C <sub>16</sub> H <sub>13</sub> F <sub>2</sub> N <sub>3</sub> O	7.27	302.1099 (*)	--	--	233.0762
DBDI	Imazalil	C <sub>14</sub> H <sub>14</sub> Cl <sub>2</sub> N <sub>2</sub> O	9.56	297.0556 (*)	--	--	261.0791
ESI	Imazalil	C <sub>14</sub> H <sub>14</sub> Cl <sub>2</sub> N <sub>2</sub> O	6.63	297.0556 (*)	--	--	--
DBDI	Mepanipirim	C <sub>14</sub> H <sub>13</sub> N <sub>3</sub>	8.84	224.1182 (*)	--	--	--
ESI	Mepanipirim	C <sub>14</sub> H <sub>13</sub> N <sub>3</sub>	8.84	224.1182 (*)	246.1002	--	--
DBDI	Myclobutanil	C <sub>15</sub> H <sub>17</sub> ClN <sub>4</sub>	8.45	289.1215 (*)	--	--	255.1604
ESI	Myclobutanil	C <sub>15</sub> H <sub>17</sub> ClN <sub>4</sub>	8.52	289.1215 (*)	311.1034	--	--
DBDI	Oxadixyl	C <sub>14</sub> H <sub>18</sub> N <sub>2</sub> O <sub>4</sub>	6.55	279.1339	--	--	219.115 (*), 102.0435
ESI	Oxadixyl	C <sub>14</sub> H <sub>18</sub> N <sub>2</sub> O <sub>4</sub>	6.55	279.1339	301.1159	317.0898	219.115 (*), 102.0435
DBDI	Pencycuron	C <sub>19</sub> H <sub>21</sub> ClN <sub>2</sub> O	10.38	329.1415 (*)	--	--	125.0177, 210.1046
ESI	Pencycuron	C <sub>19</sub> H <sub>21</sub> ClN <sub>2</sub> O	10.47	329.1415 (*)	351.1235	367.0974	125.0177
DBDI	Prochloraz	C <sub>15</sub> H <sub>16</sub> Cl <sub>3</sub> N <sub>3</sub> O <sub>2</sub>	10.03	376.0381	--	--	308.0033 (*), 282.024
ESI	Prochloraz	C <sub>15</sub> H <sub>16</sub> Cl <sub>3</sub> N <sub>3</sub> O <sub>2</sub>	9.25	376.0381	398.0200	--	308.0033 (*)
DBDI	Profenofos	C <sub>11</sub> H <sub>15</sub> BrClO <sub>3</sub> PS	11.18	372.9424 (*)	--	--	344.9132, 302.8679, 330.8985

ESI	Profenofos	C <sub>11</sub> H <sub>15</sub> BrClO <sub>3</sub> PS	11.28	372.9424 (*)	394.9244	--	344.9132, 302.8679, 330.8985
DBDI	Propachlor	C <sub>11</sub> H <sub>14</sub> CINO	7.49	212.0837 (*)	--	--	170.0367
ESI	Propachlor	C <sub>11</sub> H <sub>14</sub> CINO	7.44	212.0837	234.0656	--	170.0367 (*)
DBDI	Propiconazole	C <sub>15</sub> H <sub>17</sub> Cl <sub>2</sub> N <sub>3</sub> O <sub>2</sub>	9.87	342.0771 (*)	--	--	--
ESI	Propiconazole	C <sub>15</sub> H <sub>17</sub> Cl <sub>2</sub> N <sub>3</sub> O <sub>2</sub>	9.89	342.0771 (*)	364.059	--	--
DBDI	Propoxur	C <sub>11</sub> H <sub>15</sub> NO <sub>3</sub>	6.78	210.1125	--	--	111.0441 (*), 168.0865
ESI	Propoxur	C <sub>11</sub> H <sub>15</sub> NO <sub>3</sub>	6.78	210.1125	232.0944	--	111.0441 (*), 168.0865
DBDI	Proquinazid	C <sub>14</sub> H <sub>17</sub> IN <sub>2</sub> O <sub>2</sub>	13.32	373.0407 (*)	--	--	330.9971, 288.942
ESI	Proquinazid	C <sub>14</sub> H <sub>17</sub> IN <sub>2</sub> O <sub>2</sub>	13.23	373.0407	395.0227	--	330.9971 (*), 288.942
DBDI	Pymetrozin	C <sub>10</sub> H <sub>11</sub> N <sub>5</sub> O	5.7	218.1036 (*)	--	--	105.0447, 107.0604
ESI	Pymetrozin	C <sub>10</sub> H <sub>11</sub> N <sub>5</sub> O	3.96	218.1036 (*)	240.0856	256.0595	105.0447, 107.0604
DBDI	Quinoxyfen	C <sub>15</sub> H <sub>8</sub> Cl <sub>2</sub> FNO	12.1	308.004 (*)	--	--	--
ESI	Quinoxyfen	C <sub>15</sub> H <sub>8</sub> Cl <sub>2</sub> FNO	11.97	308.004 (*)	--	--	--
DBDI	Spiromesifen	C <sub>23</sub> H <sub>30</sub> O <sub>4</sub>	12.34	371.2217 (*)	--	--	255.1417
ESI	Spiromesifen	C <sub>23</sub> H <sub>30</sub> O <sub>4</sub>	12.49	371.2217 (*)	393.2036	--	255.1417
DBDI	Tebufenpyrad	C <sub>18</sub> H <sub>24</sub> CIN <sub>3</sub> O	11.48	334.1681 (*)	--	--	300.2068
ESI	Tebufenpyrad	C <sub>18</sub> H <sub>24</sub> CIN <sub>3</sub> O	11.55	334.1681 (*)	356.15	372.1239	--
DBDI	Tetrachlorvinphos	C <sub>10</sub> H <sub>9</sub> Cl <sub>4</sub> O <sub>4</sub> P	9.28	364.9065	--	--	127.0178 (*)
ESI	Tetrachlorvinphos	C <sub>10</sub> H <sub>9</sub> Cl <sub>4</sub> O <sub>4</sub> P	9.36	364.9065	386.8885	402.8624	127.0178 (*), 240.8975
DBDI	Acephate	C <sub>4</sub> H <sub>10</sub> NO <sub>3</sub> PS	3.96	184.0192	--	--	142.0024 (*)
ESI	Acephate	C <sub>4</sub> H <sub>10</sub> NO <sub>3</sub> PS	3.92	184.0192	206.0011	--	142.9924 (*)
DBDI	Methomyl	C <sub>5</sub> H <sub>10</sub> N <sub>2</sub> O <sub>2</sub> S	5.65	163.0536	--	--	88.0215, 106.0321
ESI	Methomyl	C <sub>5</sub> H <sub>10</sub> N <sub>2</sub> O <sub>2</sub> S	5.68	163.0536	185.0358 (*)	--	88.0215, 106.0321, 128.0153
DBDI	Chlorpropham	C <sub>10</sub> H <sub>12</sub> NO <sub>2</sub> Cl	8.47	214.0628	--	--	172.016 (*), 154.0054
ESI	Chlorpropham	C <sub>10</sub> H <sub>12</sub> NO <sub>2</sub> Cl	8.71	214.0628	236.0449	--	172.016 (*), 154.0054
DBDI	Carbendazim	C <sub>9</sub> H <sub>9</sub> N <sub>3</sub> O <sub>2</sub>	6.45	192.0768 (*)	--	--	160.0505
ESI	Carbendazim	C <sub>9</sub> H <sub>9</sub> N <sub>3</sub> O <sub>2</sub>	5.54	192.0768 (*)	--	--	160.0505

Resultados y discusión

DBDI	Thiabendazole	C <sub>10</sub> H <sub>7</sub> N <sub>3</sub> S	6.73	202.0433 (*)	--	--	--
ESI	Thiabendazole	C <sub>10</sub> H <sub>7</sub> N <sub>3</sub> S	5.78	202.0433 (*)	--	--	--
DBDI	Simazine	C <sub>7</sub> H <sub>12</sub> ClN <sub>5</sub>	6.92	202.0854 (*)	--	--	--
ESI	Simazine	C <sub>7</sub> H <sub>12</sub> ClN <sub>5</sub>	7.00	202.0854 (*)	--	--	--
DBDI	Atrazine	C <sub>8</sub> H <sub>14</sub> ClN <sub>5</sub>	7.46	216.1010 (*)	--	--	174.0541
ESI	Atrazine	C <sub>8</sub> H <sub>14</sub> ClN <sub>5</sub>	7.55	216.1010 (*)	--	--	174.0541
DBDI	Acetamiprid	C <sub>10</sub> H <sub>11</sub> ClN <sub>4</sub>	6.16	223.0745 (*)	--	--	126.0105
ESI	Acetamiprid	C <sub>10</sub> H <sub>11</sub> ClN <sub>4</sub>	6.2	223.0745 (*)	245.0564	--	126.0105
DBDI	Dimethoate	C <sub>5</sub> H <sub>12</sub> NO <sub>3</sub> PS <sub>2</sub>	6.2	230.0069	--	--	124.9821 (*), 170.9698, 198.9647, 156.9541, 142.9925
ESI	Dimethoate	C <sub>5</sub> H <sub>12</sub> NO <sub>3</sub> PS <sub>2</sub>	6.25	230.0069	251.9888	--	124.9821 (*), 170.9698, 198.9647, 156.9541, 142.9925
DBDI	Terbutylazine	C <sub>9</sub> H <sub>16</sub> ClN <sub>5</sub>	8.22	230.1167 (*)	--	--	174.0541
ESI	Terbutylazine	C <sub>9</sub> H <sub>16</sub> ClN <sub>5</sub>	8.39	230.1167 (*)	--	--	174.0541
DBDI	Diuron	C <sub>9</sub> H <sub>10</sub> Cl <sub>2</sub> N <sub>2</sub> O	7.62	233.0243 (*)	--	--	--
ESI	Diuron	C <sub>9</sub> H <sub>10</sub> Cl <sub>2</sub> N <sub>2</sub> O	7.79	233.0243 (*)	255.0062	--	--
DBDI	Thiacloprid	C <sub>10</sub> H <sub>9</sub> ClN <sub>4</sub> S	6.31	253.0309 (*)	--	--	126.0081
ESI	Thiacloprid	C <sub>10</sub> H <sub>9</sub> ClN <sub>4</sub> S	6.36	253.0309 (*)	253.0309	--	126.0081
DBDI	Imidacloprid	C <sub>9</sub> H <sub>10</sub> ClN <sub>5</sub> O <sub>2</sub>	6.04	256.0596 (*)	--	--	175.0978, 209.0589
ESI	Imidacloprid	C <sub>9</sub> H <sub>10</sub> ClN <sub>5</sub> O <sub>2</sub>	6.01	256.0596	278.0415 (*)	--	175.0978, 209.0589
DBDI	Trichlorfon	C <sub>4</sub> H <sub>8</sub> Cl <sub>3</sub> PO <sub>4</sub>	6.23	256.9299	--	--	111.0206 (*), 109.0049, 220.9532
ESI	Trichlorfon	C <sub>4</sub> H <sub>8</sub> Cl <sub>3</sub> PO <sub>4</sub>	6.23	256.9299 (*)	278.9118	--	109.0049, 220.9532
DBDI	Metalaxyl	C <sub>15</sub> H <sub>21</sub> NO <sub>4</sub>	7.4	280.1543 (*)	--	--	220.1332, 192.1383, 248.1281
ESI	Metalaxyl	C <sub>15</sub> H <sub>21</sub> NO <sub>4</sub>	7.51	280.1543	302.1363 (*)	--	220.1332, 192.1383, 248.1281, 160.1121
DBDI	Penconazole	C <sub>13</sub> H <sub>15</sub> Cl <sub>2</sub> N <sub>3</sub>	9.62	284.0716 (*)	--	--	--
ESI	Penconazole	C <sub>13</sub> H <sub>15</sub> Cl <sub>2</sub> N <sub>3</sub>	9.62	284.0716 (*)	306.0535	--	158.9763
DBDI	Thiametoxam	C <sub>8</sub> H <sub>10</sub> ClN <sub>5</sub> O <sub>3</sub> S	5.72	292.0266	--	--	248.0255 (*), 211.0648
ESI	Thiametoxam	C <sub>8</sub> H <sub>10</sub> ClN <sub>5</sub> O <sub>3</sub> S	5.76	292.0266	314.0085	--	211.0648 (*)
DBDI	Fenhexamid	C <sub>14</sub> H <sub>17</sub> Cl <sub>2</sub> NO <sub>2</sub>	8.71	302.0709 (*)	--	--	--

ESI	Fenhexamid	C <sub>14</sub> H <sub>17</sub> Cl <sub>2</sub> NO <sub>2</sub>	8.93	302.0709 (*)	326.0509	--	--
DBDI	Diazinon	C <sub>12</sub> H <sub>21</sub> N <sub>2</sub> O <sub>3</sub> PS	9.78	305.1083 (*)	--	--	153.1022
ESI	Diazinon	C <sub>12</sub> H <sub>21</sub> N <sub>2</sub> O <sub>3</sub> PS	9.98	305.1083 (*)	327.0903	--	169.0794
DBDI	Pirimiphos-methyl	C <sub>11</sub> H <sub>20</sub> N <sub>3</sub> O <sub>3</sub> PS	10.21	306.1036 (*)	--	--	--
ESI	Pirimiphos-methyl	C <sub>11</sub> H <sub>20</sub> N <sub>3</sub> O <sub>3</sub> PS	9.83	306.1036 (*)	--	--	--
DBDI	Buprofezin	C <sub>16</sub> H <sub>23</sub> N <sub>3</sub> OS	11.64	306.1635 (*)	--	--	250.1009, 201.1065, 106.0685
ESI	Buprofezin	C <sub>16</sub> H <sub>23</sub> N <sub>3</sub> OS	11.64	306.1635 (*)	--	--	250.1009, 201.1065, 106.0685
DBDI	Tebuconazole	C <sub>16</sub> H <sub>22</sub> ClN <sub>3</sub> O	9.62	308.1524 (*)	--	--	--
ESI	Tebuconazole	C <sub>16</sub> H <sub>22</sub> ClN <sub>3</sub> O	9.88	308.1524 (*)	330.1344	--	--
DBDI	Triazophos	C <sub>12</sub> H <sub>16</sub> N <sub>3</sub> O <sub>3</sub> PS	8.5	314.0723 (*)	--	--	162.0664, 286.041, 119.0604
ESI	Triazophos	C <sub>12</sub> H <sub>16</sub> N <sub>3</sub> O <sub>3</sub> PS	8.72	314.0723 (*)	336.0542	--	162.0664, 286.041, 119.0604
DBDI	Triticonazole	C <sub>17</sub> H <sub>20</sub> ClN <sub>3</sub> O	8.81	318.1368 (*)	--	--	--
ESI	Triticonazole	C <sub>17</sub> H <sub>20</sub> ClN <sub>3</sub> O	8.87	318.1368 (*)	340.1187	--	--
DBDI	Pyriproxifen	C <sub>20</sub> H <sub>19</sub> NO <sub>3</sub>	11.82	322.1438 (*)	--	--	227.1067
ESI	Pyriproxifen	C <sub>20</sub> H <sub>19</sub> NO <sub>4</sub>	12.03	322.1438 (*)	344.1257	--	227.1067
DBDI	Epoxiconazole	C <sub>17</sub> H <sub>13</sub> ClFN <sub>3</sub> O	8.97	330.0804 (*)	--	--	--
ESI	Epoxiconazole	C <sub>17</sub> H <sub>13</sub> ClFN <sub>3</sub> O	8.97	330.0804 (*)	354.0623	--	--
DBDI	Malathion	C <sub>10</sub> H <sub>19</sub> O <sub>6</sub> PS <sub>2</sub>	8.25	331.0433			285.0015 (*), 127.039, 257.0117
ESI	Malathion	C <sub>10</sub> H <sub>19</sub> O <sub>6</sub> PS <sub>2</sub>	8.47	331.0433	353.0253 (*)		285.0015, 127.039
DBDI	Hexythiazox	C <sub>17</sub> H <sub>21</sub> ClN <sub>2</sub> O <sub>2</sub> S	12.09	353.1085 (*)	--	--	228.0268, 271.0303, 168.0575
ESI	Hexythiazox	C <sub>17</sub> H <sub>21</sub> ClN <sub>2</sub> O <sub>2</sub> S	12.16	353.1085	375.0904 (*)	--	228.0268, 271.0303, 168.0575
DBDI	Chlorphenvinphos	C <sub>12</sub> H <sub>14</sub> Cl <sub>3</sub> O <sub>4</sub> P	9.69	358.9768 (*)	--	--	204.9373
ESI	Chlorphenvinphos	C <sub>12</sub> H <sub>14</sub> Cl <sub>3</sub> O <sub>4</sub> P	9.94	358.9768 (*)	380.9563	--	204.9373
DBDI	Rotenone	C <sub>23</sub> H <sub>22</sub> O <sub>6</sub>	9.1	395.1489 (*)	--	--	--
ESI	Rotenone	C <sub>23</sub> H <sub>22</sub> O <sub>6</sub>	9.34	395.1489 (*)	417.1309	433.1048	--
DBDI	Azoxystrobin	C <sub>22</sub> H <sub>17</sub> N <sub>3</sub> O <sub>5</sub>	7.66	404.1241 (*)	--	--	372.0979
ESI	Azoxystrobin	C <sub>22</sub> H <sub>17</sub> N <sub>3</sub> O <sub>5</sub>	7.83	404.1241 (*)	426.106	--	372.0979



Resultados y discusión

DBDI	Difenoconazole	C <sub>19</sub> H <sub>17</sub> Cl <sub>2</sub> N <sub>3</sub> O <sub>3</sub>	10.4	406.0720 (*)	--	--	--
ESI	Difenoconazole	C <sub>19</sub> H <sub>17</sub> Cl <sub>2</sub> N <sub>3</sub> O <sub>6</sub>	10.67	406.0720 (*)	428.1385	--	--
DBDI	Trifloxystrobin	C <sub>20</sub> H <sub>19</sub> F <sub>3</sub> N <sub>2</sub> O <sub>4</sub>	10.49	409.1370 (*)	--	--	186.0500, 206.0812, 162.0913
ESI	Trifloxystrobin	C <sub>20</sub> H <sub>19</sub> F <sub>3</sub> N <sub>2</sub> O <sub>4</sub>	10.73	409.1370 (*)	431.1189	--	186.0500, 206.0812, 162.0913
DBDI	Spinosad (Spinosyn A)	C <sub>41</sub> H <sub>65</sub> NO <sub>10</sub>	7.74	732.4681 (*)	--	--	142.1226
ESI	Spinosad (Spinosyn A)	C <sub>41</sub> H <sub>65</sub> NO <sub>10</sub>	9.03	732.4681 (*)	754.4501	770.424	--
DBDI	Spinosad (Spinosyn D)	C <sub>42</sub> H <sub>67</sub> NO <sub>10</sub>	8.28	746.4838 (*)	--	--	142.1226
ESI	Spinosad (Spinosyn D)	C <sub>42</sub> H <sub>67</sub> NO <sub>10</sub>	9.59	746.4838 (*)	768.4657	784.4397	--

<sup>a</sup> Fragments are ordered in increasing order of relative abundance.

(\*) Most abundant ion in the spectrum has been marked with (\*).

Table 2. LC-DBDI-HRMS determination of non-ESI-amenable compounds by DBDI in negative ionization mode, including spectral features and retention time.

Compound	Formula (M)	Ret. time (min)	Most abundant ion	Theoretical $m/z$	Other species
1,3-Hexachlorobutadiene	C <sub>4</sub> Cl <sub>6</sub>	10.52	[M-Cl+O] <sup>-</sup>	238.8397	222.869
Aldrin	C <sub>12</sub> H <sub>8</sub> Cl <sub>6</sub>	11.4	[M-3Cl] <sup>-</sup>	256.9697	258.8704, 284.0012, 240.9825, 194.9177, 316.9985
Chlorothalonil	C <sub>8</sub> Cl <sub>4</sub> N <sub>2</sub>	8.33	[M-Cl+O] <sup>-</sup>	244.9082	--
Dicofol	C <sub>14</sub> H <sub>9</sub> Cl <sub>5</sub> O	10.58	[M-H] <sup>-</sup>	366.9023	402.8790, 277.992, 296.9664
Dieldrin	C <sub>12</sub> H <sub>8</sub> Cl <sub>6</sub> O	6.41	[M-HCl <sub>4</sub> ] <sup>-</sup>	236.9879	411.8322, 203.0293, 236.9905, 270.9519, 304.9133
Endosulfan $\alpha$	C <sub>9</sub> H <sub>6</sub> Cl <sub>6</sub> SO <sub>3</sub>	10.56	[M-HSO <sub>2</sub> ] <sup>-</sup>	338.8477	438.7863, 386.8395, 340.8419, 304.8662, 260.9704, 228.9443
Endosulfan $\beta$	C <sub>9</sub> H <sub>6</sub> Cl <sub>6</sub> SO <sub>3</sub>	10.13	[M-H] <sup>-</sup>	402.8096	438.7863, 370.843, 340.8418, 304.8702
Endosulfan sulfate	C <sub>9</sub> H <sub>6</sub> Cl <sub>6</sub> SO <sub>4</sub>	9.28	[M-Cl] <sup>-</sup>	384.8435	386.8424
Endrin	C <sub>12</sub> H <sub>8</sub> Cl <sub>6</sub> O	10.6	[M-3HCl] <sup>-</sup>	269.9411	411.8322, 269.9431, 286.9431, 255.9697
HCH $\alpha$ , $\beta$ , $\gamma$ , $\Delta$ (peak1)	C <sub>6</sub> H <sub>6</sub> Cl <sub>6</sub>	8.47	[M-2H+Cl] <sup>-</sup>	321.8481	322.8333, 194.9179, 160.9569
HCH $\alpha$ , $\beta$ , $\gamma$ , $\Delta$ (peak2)	C <sub>6</sub> H <sub>6</sub> Cl <sub>6</sub>	9.57	[M+Cl] <sup>-</sup>	322.8295	322.8295, 194.9179, 160.9569
Heptachlor	C <sub>10</sub> H <sub>5</sub> Cl <sub>7</sub>	10.9	[M-2Cl] <sup>-</sup>	299.8839	299.8651, 265.9037, 280.8909, 334.8384
Heptachlorepoxyde	C <sub>10</sub> H <sub>5</sub> Cl <sub>7</sub> O	10.32	[M-O] <sup>-</sup>	368.8138	368.8393
Hexachlorobenzene	C <sub>6</sub> Cl <sub>6</sub>	12.08	[M-Cl+O] <sup>-</sup>	262.8397	230.8787
Pentachlorobenzene	C <sub>6</sub> HCl <sub>5</sub>	11.33	[M-Cl+O] <sup>-</sup>	228.8787	--
Quintozene	C <sub>6</sub> Cl <sub>5</sub> NO <sub>2</sub>	10.81	[M-Cl+O] <sup>-</sup>	273.8638	--

**Table 3.** Evaluation of matrix effects (ME) for ESI-amenable pesticides in orange matrix by ESI, APCI and DBDI.

Compound	% ME ESI	ME (%) APCI	ME (%) DBDI
Acephate	-34.0	-31.0	-16.7
Acetamiprid	-62.3	-25.7	13.1
Atrazine	-44.6	-69.0	-0.9
Azoxystrobin	-37.4	-65.3	-0.8
Bitertanol	-8.0	5.0	7.6
Boscalid	-7.1	8.3	17.9
Bromuconazol 1	-20.1	12.4	3.2
Bromuconazol 2	-10.3	3.2	-1.6
Bupirimate	-5.9	-1.2	0.8
Buprofezin	-30.1	-17.5	-1.5
Carbendazim	-13.5	-19.5	-0.2
Chlorfenvinphos	-27.6	-40.6	-9.7
Chloridazon (Pyrazon)	-45.4	1.4	3.4
Chloroxuron	-33.3	-17.8	4.4
Chlorpropham	-68.6	-53.2	8.2
Cyproconazol Iso1	-27.1	0.4	8.7
Cyproconazol Iso2	-26.8	21.8	4.1
Diazinon	-26.6	-36.1	0.9
Dichlorvos	-31.4	-18.0	-5.6
Dicrotophos	11.8	-2.6	4.6
Difenoconazole	-14.4	-44.5	2.7
Dimethoate	-49.0	-12.7	-2.8
Diniconazole	-39.1	3.0	-3.1
Diuron	-43.8	-30.5	0.3
Epoxiconazole	-18.5	31.1	2.8
Fenazaquin	1.2	20.9	24.7
Fenhexamid	-54.0	-42.8	-2.9
Fenpropimorph	-24.5	9.3	-1.5
Fluquinconazole	-43.9	-35.0	19.6
Flusilazole	-8.5	5.0	4.4

---

Flutriafol	-10.6	-7.3	17.1
Hexythiazox	-28.2	-8.7	-31.2
Imazalil	-37.7	-7.1	8.5
Imidacloprid	-74.9	-7.5	-14.4
Malathion	-39.0	-67.2	-5.6
Mepanipyrim	-39.3	-1.8	-2.3
Metalaxyl	-26.8	-18.9	3.0
Methomyl	-31.8	-2.9	-9.7
Myclobutanil	-34.2	-28.4	22.9
Oxadixyl	-36.1	-12.1	9.6
Penconazole	-14.9	3.7	-13.4
Pencycuron	-15.9	-20.1	0.4
Pirimiphos-methyl	-28.6	-22.6	-7.4
Prochloraz	-15.1	-0.7	7.2
Profenofos	-24.7	-1.0	-3.7
Propachlor	-19.8	-9.0	1.1
Propiconazole	-9.2	7.4	6.2
Propoxur	-40.1	8.3	-5.9
Proquinazid	2.2	2.9	0.9
Pymetrozin	-4.8	-11.3	-3.7
Pyriproxifen	-26.7	-3.5	5.2
Quinoxifen	-4.4	2.1	6.0
Rotenone	-48.3	0.5	2.9
Simazine	-30.3	10.1	-27.0
Spinosyn A (Spinosad)	-24.2	-71.1	-10.7
Spinosyn D (Spinosad)	8.7	-1.4	2.7
Spiromesifen	15.1	62.3	29.6
Tebuconazole	-24.9	-45.7	1.3
Tebufenpyrad	-3.8	9.7	0.1
Terbutylazine	-35.2	-47.4	0.2
Tetrachlorvinphos	-27.8	-2.7	8.2
Thiabendazole	5.2	-15.0	3.8
Thiacloprid	-46.8	-5.6	1.2

## *Resultados y discusión*

---

Thiametoxam	-67.0	0.6	-5.7
Triazophos	-72.3	-46.8	-6.5
Trifloxystrobin	-27.3	-9.4	4.4
Triticonazole	-16.6	-62.1	-15.2

---

**Table 4.** Evaluation of matrix effects (ME) for non ESI-amenable (organochlorine) pesticides in orange matrix by DBDI.

Compound	ME
1,3-Hexaclorobutadiene	2.7
Aldrin	-8.1
Chlorotalonil	-5.5
Dicofol	-5.0
Dieldrin	-29.6
Endosulfan $\alpha$	-20.0
Endosulfan $\beta$	13.2
Endosulfan sulfate	-1.0
Endrin	0.0
HCH (peak 1)	4.9
HCH (peak 2)	0.2
Heptachlor	-14.8
Heptachlorepoxyde	-16.6
Hexaclorobenzene	-4.9
Pentaclorobenzene	3.0
Quintozene	-1.0

**Table 5.** Evaluation of matrix effects (ME) for ESI-amenable pesticides in wastewater extracts by ESI, APCI and DBDI.

Compound	% ME ESI	ME (%) APCI	ME DBDI(%)
Acephate	-3.1	-1.7	9.1
Acetamiprid	-37.9	-6.2	8.8
Atrazine	-14.3	-2.8	-2.4
Azoxystrobin	-0.1	5.2	2.9
Bitertanol	-1.8	68.1	-1.7
Boscalid	-11.9	12.2	4.4
Bromuconazol 1	-7.3	0.6	3.2
Bromuconazol 2	-7.8	2.9	-1.6
Bupirimate	-2.5	11.9	-4.5
Buprofezin	-27.4	27.1	9.3
Carbendazim	-30.0	-0.6	0.6
Chlorfenvinphos	-3.0	5.6	0.7
Chloridazon (Pyrazon)	-37.4	16.9	21.7
Chloroxuron	-5.1	5.1	-1.2
Chlorpropham	-12.0	-0.7	7.0
Cyproconazol Iso1	-9.5	14.2	6.0
Cyproconazol Iso2	-6.8	7.5	-1.7
Diazinon	-7.0	6.9	-6.5
Dichlorvos	-16.2	14.1	0.3
Dicrotophos	-31.2	-28.3	-5.6
Difenoconazole	-9.3	7.6	11.9
Dimethoate	-41.5	-6.6	7.4
Diniconazole	-1.4	-4.5	4.7
Diuron	-19.2	5.8	-1.3
Epoxiconazole	-4.8	18.0	-1.9
Fenazaquin	11.5	67.5	13.3
Fenhexamid	4.7	-5.3	7.2
Fenpropimorph	-22.5	16.5	6.2
Fluquinconazole	3.1	37.6	6.1
Flusilazole	-11.2	5.0	-0.9

Flutriafol	-11.5	3.4	1.2
Hexythiazox	-18.8	9.0	10.3
Imazalil	-28.5	10.6	1.4
Imidacloprid	-45.7	-5.2	2.6
Malathion	-7.4	10.7	-1.7
Mepanipyrim	-4.1	4.2	1.5
Metalaxyl	-11.5	-0.6	1.0
Methomyl	-63.7	-18.6	14.6
Myclobutanil	-3.9	-27.4	-9.2
Oxadixyl	-12.9	4.6	-1.6
Penconazole	-7.6	6.5	0.6
Pencycuron	-0.9	4.6	2.8
Pirimiphos-methyl	-2.4	11.1	7.9
Prochloraz	-2.0	5.4	-31.5
Profenofos	-4.0	-4.9	-5.1
Propachlor	-21.6	11.6	-9.4
Propiconazole	-3.9	14.8	-4.5
Propoxur	-20.0	6.0	-6.1
Proquinazid	-1.1	55.5	11.8
Pymetrozin	-3.2	-8.9	1.6
Pyriproxifen	-15.2	-3.5	14.8
Quinoxifen	-1.2	25.0	14.1
Rotenone	-13.8	13.0	0.4
Simazine	-11.6	3.9	6.9
Spinosad (Spinosyn A)	-13.1	-27.7	-13.1
Spinosad (Spinosyn D)	2.2	5.0	-2.3
Spiromesifen	2.3	22.5	-4.5
Tebuconazole	-5.5	8.8	2.5
Tebufenpyrad	1.5	20.5	3.6
Terbuthylazine	-5.0	9.5	-1.9
Tetrachlorvinphos	-9.6	5.2	-4.3
Thiabendazole	-12.9	-60.5	5.0
Thiacloprid	-36.9	-9.3	4.4



Thiametoxam	-48.0	-68.3	-3.7
Triazophos	-11.8	10.4	3.6
Trifloxystrobin	4.2	5.9	13.8
Triticonazole	-7.6	-0.4	-1.4

---

**Table 6.** Evaluation of matrix effects (ME) for non ESI-amenable (organochlorine) pesticides in wastewater by DBDI.

Compound	ME (%)
1,3-Hexaclorobutadiene	10.1
Aldrin	-9.0
Chlorotalonil	11.5
Dicofol	-37.5
Dieldrin	9.3
Endosulfan $\alpha$	-20.0
Endosulfan $\beta$	40.1
Endosulfan sulfate	-35.8
Endrin	57.7
HCH (peak 1)	2.3
HCH (peak 2)	10.8
Heptachlor	31.0
Heptachlorepoxyde	-39.8
Hexaclorobenzene	-22.9
Pentaclorobenzene	-0.5
Quintozene	-15.2

**Table 7.** Evaluation of matrix effects (ME) for ESI-amenable pesticides in olive oil by ESI, APCI and DBDI.

Compound	% ME ESI	ME (%) APCI	ME DBDI(%)
Acephate	15.7	30.1	-4.3
Acetamiprid	-21.8	56.7	9.5
Atrazine	-6.7	-4.3	-9.4
Azoxystrobin	-9.3	16.9	-9.4
Bitertanol	-11.9	0.4	-15.7
Boscalid	-9.6	-3.8	-0.3
Bromuconazole 1	8.8	10.2	-2.4
Bromuconazole 2	-5.6	-2.2	-5.8
Bupirimate	7.3	-14.4	-4.3
Buprofezin	-3.5	46.7	-4.9
Carbendazim	-3.9	11.7	4.0
Chloridazon (Pyrazon)	-52.6	17.1	-5.5
Chloroxuron	1.4	-7.9	-14.1
Chlorphenvinphos	-10.7	-7.7	-8.0
Chlorpropham	4.5	-15.5	-12.2
Cyproconazol Iso1	-11.8	13.7	-5.8
Cyproconazol Iso2	-9.7	2.1	-7.4
Diazinon	-5.0	-2.2	-6.6
Dichlorvos	-47.5	2.2	-8.9
Diclotophos	0.4	-1.0	-2.7
Difenoconazole	-29.6	-16.6	-7.7
Dimethoate	-21.2	84.3	3.4
Diniconazole	-10.1	-7.3	-9.4
Diuron	-20.4	88.7	-9.9
Epoxiconazole	-4.3	-20.5	-4.5
Fenazaquin	-85.3	-100	-23.0
Fenhexamid	-2.7	31.4	0.6
Fenpropimorph	7.6	42.7	-1.6
Fluquinconazole	41.2	64.0	-3.0
Flusilazole	-11.5	-12.8	-6.2

---

Flutriafol	-4.4	-14.8	-2.4
Hexythiazox	17.4	-51.1	-44.8
Imazalil	-27.3	8.1	-6.7
Imidacloprid	-59.9	21.3	-8.9
Malathion	-34.1	-24.2	-46.0
Mepanipyrim	-16.8	-0.3	-0.7
Metalaxyl	7.3	40.9	-2.4
Methomyl	-19.7	20.1	-8.6
Myclobutanil	0.8	-0.2	8.1
Oxadixyl	-41.0	10.5	-6.1
Penconazole	-17.2	-7.0	-5.0
Pencycuron	-30.4	-48.6	-18.7
Pirimiphos-methyl	-48.1	-95.7	-57.9
Prochloraz	-2.2	55.6	5.4
Profenofos	-12.8	-2.0	-7.4
Propachlor	-2.3	-11.5	-7.2
Propiconazole	-7.1	-3.2	-8.3
Propoxur	7.9	-32.7	-3.2
Proquinazid	-27.9	-58.0	-0.9
Pymetrozin	-84.6	-96.4	0.7
Pyriproxifen	-18.9	-30.8	-36.5
Quinoxifen	-11.8	-34.3	7.8
Rotenone	-24.4	23.6	-2.5
Simazine	-15.1	3.4	-8.0
Spinosad (Spinosyn A)	-10.5	48.1	-1.1
Spinosad (Spinosyn D)	-2.7	95.7	8.6
Spiromesifen	-21.5	-33.5	-3.3
Tebuconazole	-17.0	22.6	-9.6
Tebufenpyrad	-25.2	-36.0	-5.4
Terbutylazine	-7.9	-6.5	-2.0
Tetrachlorvinphos	10.7	-7.1	-16.9
Thiabendazole	-8.0	90.9	-1.1
Thiacloprid	-42.4	-23.5	-4.2

Thiametoxam	-35.1	-7.6	-6.0
Triazophos	-5.4	8.7	-8.0
Trifloxystrobin	31.4	95.6	25.4
Triticonazole	-5.1	7.6	-8.2

---

**Table 8.** Evaluation of matrix effects (ME) for non ESI-amenable (organochlorine) pesticides in olive oil by DBDI.

Compound	ME (%)
1,3-Hexachlorobutadiene	18.3
Aldrin	-19.1
Chlorotalonil	6.4
Dicofol	-4.2
Dieldrin	-19.6
Endosulfan $\alpha$	1.4
Endosulfan $\beta$	20.1
Endosulfan sulfate	13.8
Endrin	0.9
HCH (peak 1)	-12.2
HCH (peak 2)	-16.6
Heptachlor	17.8
Heptachlorepoxyde	-19.8
Hexachlorobenzene	26.5
Pentachlorobenzene	-2.6
Quintozene	33.4





---

## *Conclusiones*





## V. Conclusiones

1. En esta tesis doctoral se han desarrollado cuatro métodos espectroscópicos en flujo para la determinación de parámetros de calidad y compuestos de interés en aceite de oliva virgen (AOV), implementables en laboratorios de rutina (y potencialmente implementables en almazaras para control rápido del aceite en línea). Gracias al empleo de sistemas multicomutados de análisis por inyección en flujo (MCFIA), todos ellos son respetuosos con el medio ambiente, generan muy pocos desechos y emplean disolventes no tóxicos, en línea con las tendencias actuales de la Química Analítica Verde.

El método espectrofotométrico basado en la inhibición del radical catión DMPD<sup>•+</sup> (artículo 1) permitió la determinación de compuestos fenólicos/antioxidantes con una drástica reducción del tiempo por análisis (8 muestras/hora) respecto al método de Folin-Ciocalteu (aprox. 1 muestra/hora), con el que mostró muy buena correlación.

La determinación quimioluminiscente de compuestos fenólicos/antioxidantes por reacción directa con permanganato potásico permitió analizar 180 muestras (extractos)/hora y es el primer método automático descrito para determinación de fenoles/antioxidantes en AOV por quimioluminiscencia directa. Respecto al anterior método para determinación de compuestos fenólicos, la frecuencia de muestreo se multiplica por más de 20, evitando la incubación de la muestra (que implica el uso de reactor y sistema de calefacción). Si bien el método espectrofotométrico se ajusta mejor a los valores obtenidos con el método de Folin-Ciocalteu ( $r=0.9706$ ) que el quimioluminiscente ( $r=0.9442$ ), ambos correlacionan bien.

La determinación quimioluminiscente del índice de peróxidos se basa en la reacción del luminol con los hidroperóxidos procedentes de la oxidación de los glicéridos y ácidos grasos. El método permite la determinación del índice de peróxidos en el intervalo de 14 a 220 meq O<sub>2</sub>/kg (adecuado para verificar si la muestra satisface los requerimientos normativos) a razón de 45 muestras/hora. Frente al método oficial destaca su rapidez, comodidad, precisión y respeto medioambiental. Es el primer método automático descrito para la determinación del índice de peróxidos basado en medidas quimioluminiscentes.

El método desarrollado para determinación de tocoferoles totales y estimación directa de  $\alpha$ -tocoferol, basado en la medida de la fluorescencia intrínseca que presentan estos compuestos, no requiere ningún tratamiento previo de la muestra. Además, permitió analizar 40 muestras/hora, frente a las 2-4 muestras/h que requiere el método oficial mediante HPLC con detección fluorescente.

2. En esta tesis, además, se ha evaluado el uso de espectrometría de masas acoplada a nuevas fuentes de ionización para el análisis directo de aceite de oliva y para la determinación de residuos de plaguicidas:

Se ha evaluado el uso de la espectrometría de masas directa con fuentes de ionización ambiental (AMIS) para la caracterización del AOV, usando plasma de baja temperatura (LTP) y Papel Spray (PS). En ambos casos se minimiza el efecto memoria comparado con la infusión directa (sólo una fracción de muestra es desorbida) y permiten el análisis del AOV directo o diluido. La información sobre la muestra proporcionada por ambas técnicas es diferente: compuestos con  $mz > 500$  prácticamente no se desorben de la muestra cuando se emplea LTP. Por tanto, no se obtiene información sobre tri- y diglicéridos. La técnica PS resulta superior a LTP en este aspecto, ionizándose un mayor rango de especies, lo que puede permitir la clasificación de las muestras. Además, el uso de sales de plata en PS ofrece la posibilidad de análisis de compuestos insaturados, proporcionando información sobre el perfil de muestras de AOV en dichos compuestos.

El uso de una fuente de ionización basada en la descarga de barrera dieléctrica (DBDI) permitió el análisis multiresiduo de plaguicidas con resultados muy satisfactorios, dado que permite la detección de compuestos ionizables por fuentes convencionales (ESI, APCI) y muchos no ionizables por las mismas, presentando así, respecto a éstas, una mayor cobertura de ionización de analitos con distintas propiedades fisicoquímicas. El uso de un pulso eléctrico de onda cuadrada mejoró la sensibilidad y el efecto matriz tanto en comparación con las fuentes convencionales, como en comparación con referencias previas del uso de DBDI en otras matrices vegetales.







---

## *Conclusions*



## IV. Conclusions

1. In this thesis, four flow spectroscopic methods have been developed for the determination of quality parameters and compounds of interest in virgin olive oil (VOO), which could be implemented in routine laboratories (and potentially used in mills for rapid VOO control). Due to the use of multicommuted systems for flow injection analysis (MCFIA), all of them could be considered environmentally friendly, since they generate low amounts of waste and employ non-toxic solvents, in line with current trends in Green Analytical Chemistry.

The spectrophotometric method based on the inhibition of the cationic radical DMPD<sup>+</sup> allowed the determination of phenolic compounds/ antioxidants with a drastic reduction in analysis time (8 samples/hour) with respect to the reference Folin-Ciocalteu method (approx. 1 sample/hour), both being well correlated.

The chemiluminescent determination of phenolic compounds/antioxidants by direct reaction with potassium permanganate allowed the analysis of 180 samples (extracts)/hour and is the first automatic method described for determination of phenols/antioxidants in VOO by direct chemiluminescence. With respect to the previous method for the determination of phenolic compounds, the sampling frequency is multiplied by more than 20, so avoiding the incubation of the sample, (ie the use of reactor and heating system). Although the spectrophotometric method is better correlated to the values obtained with the Folin-Ciocalteu method ( $r = 0.9706$ ) used as reference than the chemiluminescent one is ( $r = 0.9442$ ), both are well correlated to the reference method.

The chemiluminescent determination of the peroxide value is based on the reaction of luminol with hydroperoxides from the oxidation of glycerides and fatty acids. The method allows the determination of the peroxide value in the range of 14 to 220 meq O<sub>2</sub>/kg (suitable to verify if the sample meets regulatory requirements) at the rate of 45 samples/hour. Regarding the official method, it should be emphasized its speed, simplicity, precision and environmental re-



spect. It is the first automatic method described for the determination of the peroxide value based on chemiluminescent measurements.

The method developed for determination of total tocopherols and direct estimation of  $\alpha$ -tocopherol, based on the measurement of the intrinsic fluorescence present in these compounds, does not require any sample treatment. In addition, it allowed the analysis of 40 samples/hour, which is significantly higher than 2 samples/h that can be analyzed by the official method using HPLC with fluorescent detection.

2. In this thesis, we have also evaluated the use of new ionization sources for the direct analysis of olive oil components by mass spectrometry and for the determination of residues of pesticides:

The use of direct ambient ionization mass spectrometry (AIMS) sources for the characterization of VOO using low temperature plasma (LTP) and Paper Spray (PS) has been evaluated. In both cases, the carry-over is minimized compared to the direct infusion of the sample (only a fraction of the sample is desorbed) into the mass spectrometer and allow analysis of both diluted and undiluted VOO. The information on the sample provided by both ionization techniques is different: compounds with  $m/z > 500$  are practically not desorbed from the sample when LTP is used. Therefore, no information on tri- and diglycerides is obtained. The PS technique is superior to LTP in this aspect, ionizing a greater range of species, which can allow the classification of the samples. In addition, the use of silver salts in PS offers the possibility of analysis of unsaturated compounds, providing information on the profile of VOO samples in these compounds.

The use of an ionization source based on the dielectric barrier discharge (DBDI) for the multiresidue analysis of pesticides was explored with satisfactory results, as it allows the detection of compounds ionized by conventional sources (ESI, APCI) and many others non-ionized by these ionization sources, so reaching, regarding conventional sources, a greater coverage of ionization of analytes with

different physicochemical properties. The use of a square wave electric pulse improved the sensitivity and matrix effect compared to both conventional sources and previous work described in the literature which used DBDI for the analysis of other vegetable matrices.